

Lab 12: Shift Register

12.1 Aim

To Design and verify the function of Truth Table.

12.2 Objective:

- To investigate the operation of the shift registers.

12.3 Background:

A register capable of shifting its binary information either to right or to the left is called a shift register. The simplest possible shift register is one that uses only flip-flops, as shown in figure 10.1. The Q output of a given flip-flop is connected to the D input of the flip-flop at its right. Each clock pulse shifts the contents of the register one bit position to the right. The serial input determines what goes into the leftmost flip-flop during the shift. The serial output is taken from the output of the rightmost flip-flop prior to the application of a pulse. Although this register shifts its contents to the right, if we turn the page upside down; we find that the register shifts its contents to the left. Thus a unidirectional shift register can function either as a shift-right or as shift-left register.

• The register in figure 10.1 shifts its contents with every clock pulse during the positive edge of the pulse transition. If we want to control the shift so that it occurs only with certain pulses but not with others, we must control CLK input of the register. Shift registers can be used for converting serial data to parallel, and vice versa. If we have access to all the flip-flop outputs of a shift register, then information entered serially by shifting can be taken out in parallel from the outputs of the flip-flops. If a parallel-load capability is added to a shift register, then data entered in parallel can be taken out in serial fashion by shifting the data stored in the register.

There are five basic types of shift registers:

- Serial In - Serial Out.

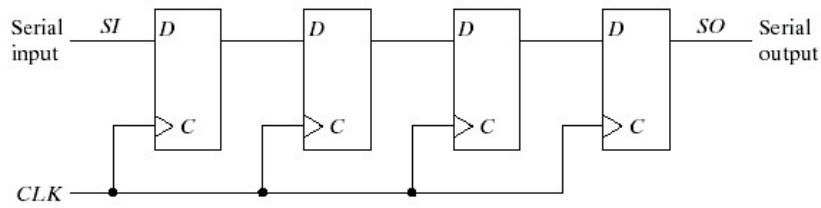

Figure 12.1: 4-bit Shift Register

- Serial In - Parallel Out.
- Parallel In - Serial Out.
- Parallel In - Parallel Out.
- Bidirectional shift registers.

Some shift registers provide the necessary input and output terminals for parallel transfer. They may also have both shift-right and right-shift capabilities. The most general shift register has all the following capabilities:

1. 1. A clear control to clear the register to 0.
2. 2. A CP (or CLK) input for clock pulses to synchronize all operations.
3. 3. A shift-right control to enable the shift-right operation and the serial input and output lines associated with the shift right.
4. 4. A shift-left control to enable the shift-left operation and the serial input and output lines associated with the shift left.
5. 5. A parallel-load control to enable a parallel transfer and the n input lines associated with the parallel transfer.
6. 6. n parallel output lines.
7. 7. A control state that leaves the information in the register unchanged even though clock pulses are continuously applied

12.4 Lab Work

12.4.1 Parts List:

1. 1- module KL-33008
2. 2- 74LS164 (8-bit shift register:serial In-Parallel Out Register)
3. 3- 74LS165 (8-bit Parallel -to-Serial Shift Register)
4. 4- Two 74LS194 ICs (bidirectional shift Register)

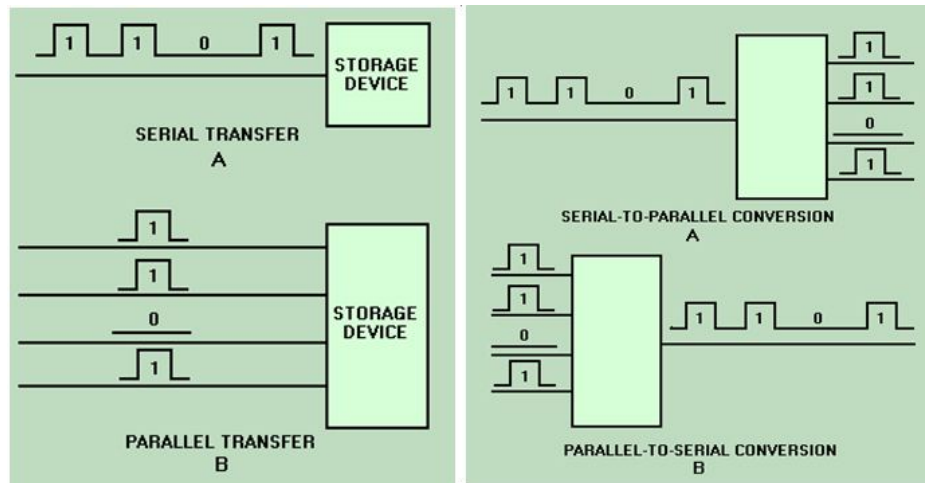

Figure 12.2: Modes of data transfer

12.4.2 Serial-In Parallel-Out Shift Register

The 74x164 is an 8 bit SI/PO shift register. Serial data is entered through a 2 AND gate synchronous with the LOW to high transition of the clock.

- a) Derive the functional table for the 74x164 and verify it experimentally.
- b) Show that the 74x164 acts as SI/PO shift register. Enter the data 11001010 serially after how many clock pulses can you get the data at the output simultaneously. Fill in the timing diagram below

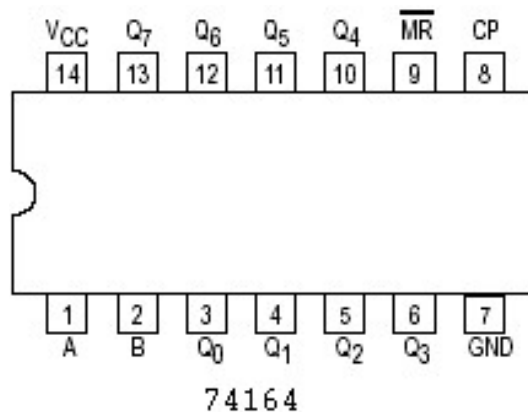

Figure 12.3: Pin specifications of 74164 IC

12.4.3 Parallel-In Series-out/Serial-In Serial-out Register

The 74x165 is an 8 bit parallel load or serial in with serial output taken at the last bit Q7.

- Derive the functional table for the 74x165 and verify it experimentally.
- Show that the 74x165 acts as PI/SO shift register. Enter the data 11001010 in parallel mode, after how many clock pulses can you get the data at the output serially.
- Repeat part (b) but use SI/SO mode and count the pulses needed to take the data at the output.

12.4.4 Bidirectional Shift Register

The 74LS194 is a high speed 4-bit bidirectional universal shift register. It is useful in a wide variety of applications. It may be used in serial-serial, shift left, shift right, serial-parallel, parallel-serial and parallel-parallel data register transfer.

- Connect the 74194 to the breadboard with appropriate inputs and outputs.
- Fill in the timing diagram below

12.5 Results and Discussion:

Excess-3 code is a 4-bit un-weighted code and can be obtained from the corresponding value of BCD code by adding three to each coded number. Excess-3 code is self complementing in nature because 1's complement of the coded number yields 9's complement of number itself.

12.6 Conclusion:

various types of shift register have been implemented and verified using ICs.

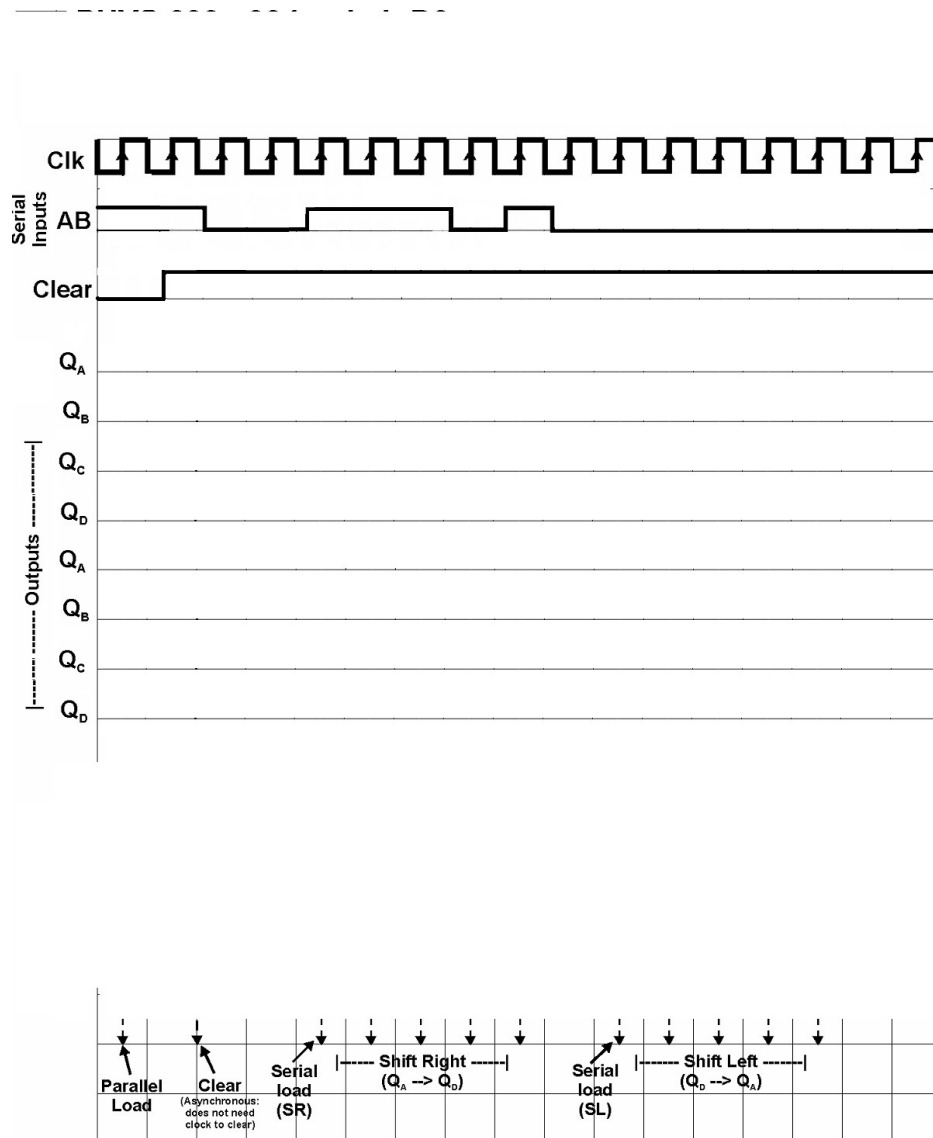

Figure 12.4: Shift Register Timing diagram

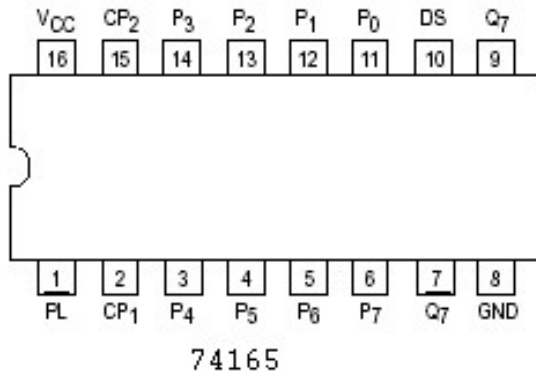

Figure 12.5: Shift Register 74165 IC pin specifications

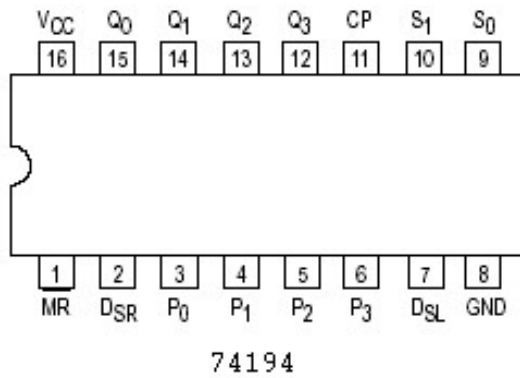

Figure 12.6: Shift Register 74194 IC pin specifications

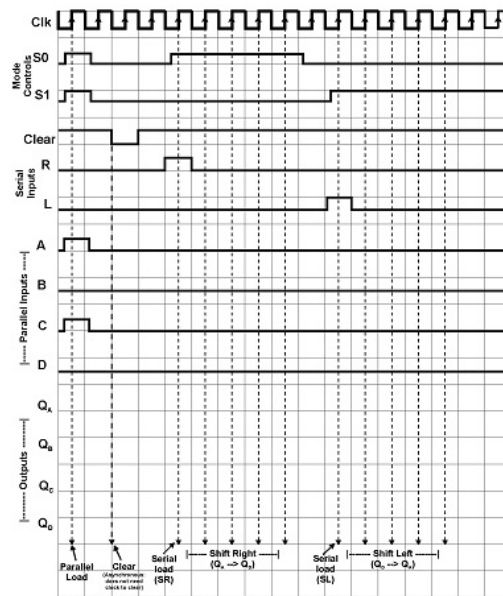

Figure 12.7: Shift Register 74194 IC Timing Diagram