

# Architecture & Town Planning

## Lecture 5B: Sustainable/ Efficient Buildings



Ar. Alina Babar

Lecture, Civil Department, INU

[alinababar1992@gmail.com](mailto:alinababar1992@gmail.com)

# Passive Cooling



# 1. Thermal Zoning

- ∞ We like different temperatures in different rooms- we like bathrooms to be very warm, living rooms to be a comfortable cozy temperature, and bedrooms to be cooler.
- ∞ An efficient eco-house creates different thermal zones for the different rooms.



Hot zone	20-23°	Bathrooms, rooms for drying clothes, kitchen
Warm zone	18-21°	Living rooms, study, children's bedrooms
Cool zone	16-18°	Adult bedrooms
Cold zone	under 16°	Rooms that are not in use, storage rooms, garage, basement

### ∞ Hot zone

South facing window may be better for a bathroom where natural lighting and good ventilation is desirable.

### ∞ Warm zone

The main living rooms need constant warmth and light and are best placed on the South side of the house with large windows and good thermal capacity to hold any thermal gain through the evening.

### ∞ Cool zone

Adult bedrooms can be placed on the cooler side of the house. However, they need good light and an easterly window or skylight is preferred.

### ∞ Cold zone

Little used rooms are best located along the colder and darker North side of the house. Storage rooms need to be kept dry but heat, light, and thermal capacity are of little concern, though the preference is for constant cool temperatures.

# 2. Narrow/ Open Planning

Cool breezes work best in narrow or open plan layouts

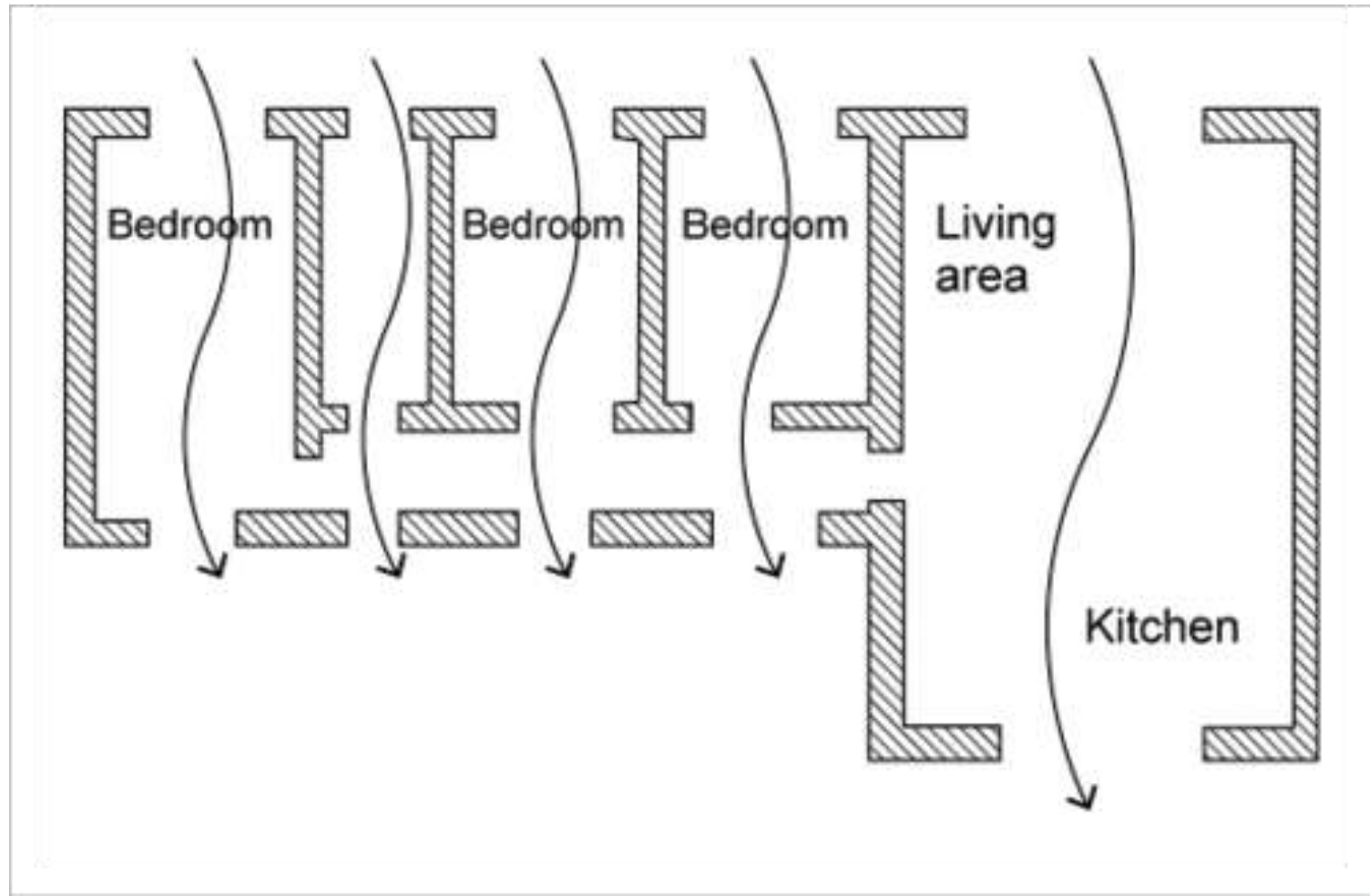

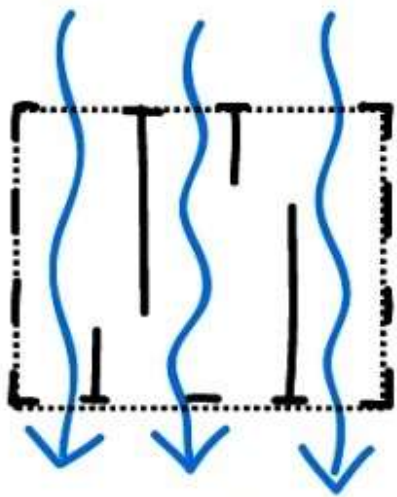

Walls running parallel to the breeze, aid in cross-ventilation.

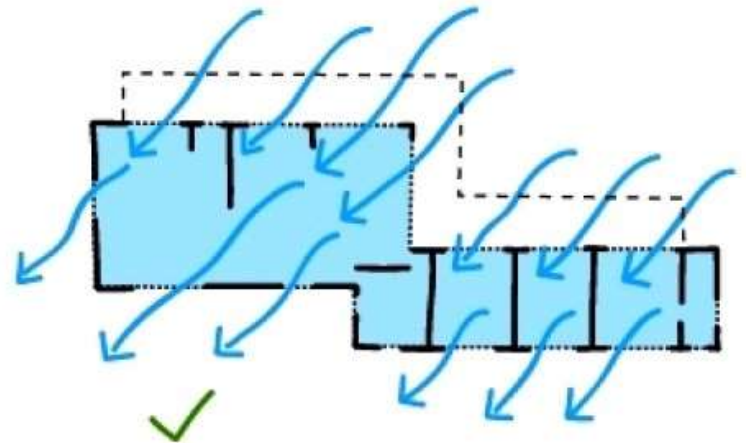
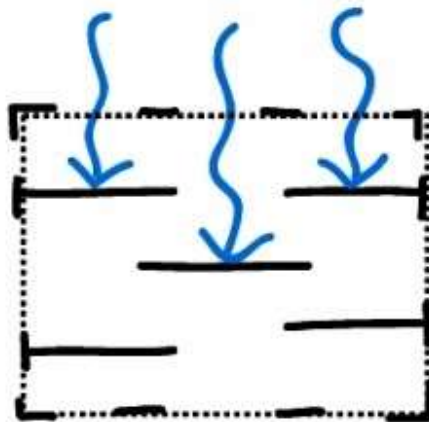

A well designed home with single room

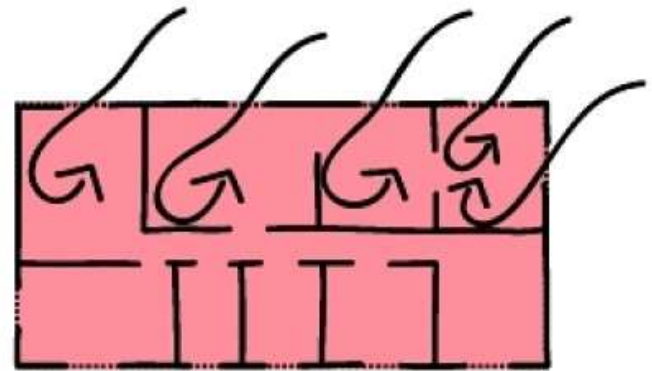

A poorly designed home that will create hot stagnant areas.

# 3. Cross Ventilation

- ∞ Outdoor breezes create air movement through the house interior by the 'push-pull' effect of positive air pressure on the windward side and negative pressure (suction) on the leeward side.
- ∞ In order to have a good natural ventilation, openings must be placed at opposite pressure zones.



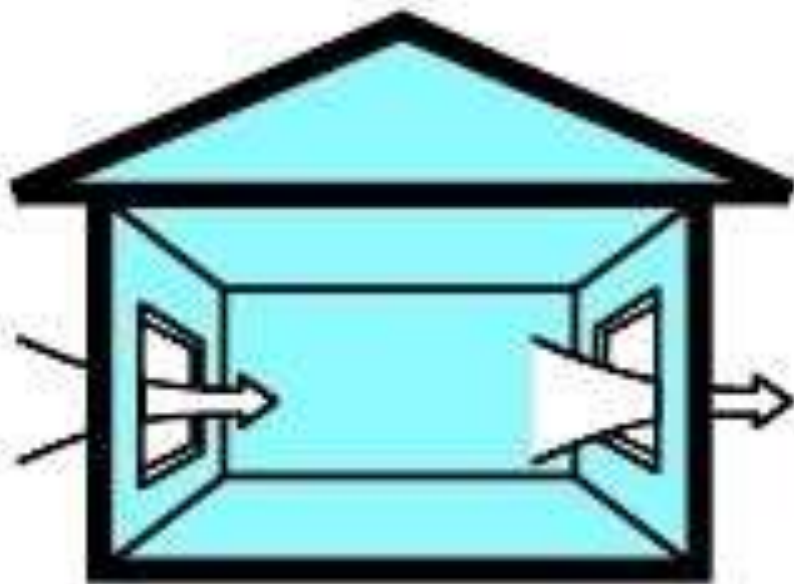

inside air  
speed 35%  
of outside

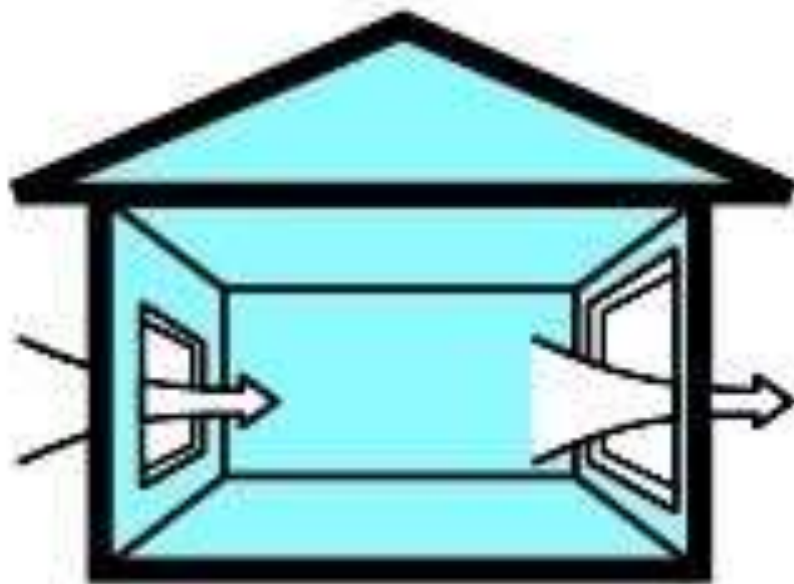

inside air  
speed 44%  
of outside

Relative window opening sizes

**Sliding window**

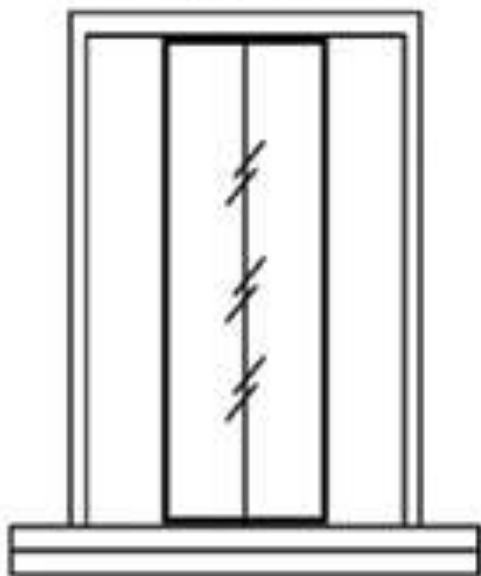

**50% open  
for breeze**

**Louvres**

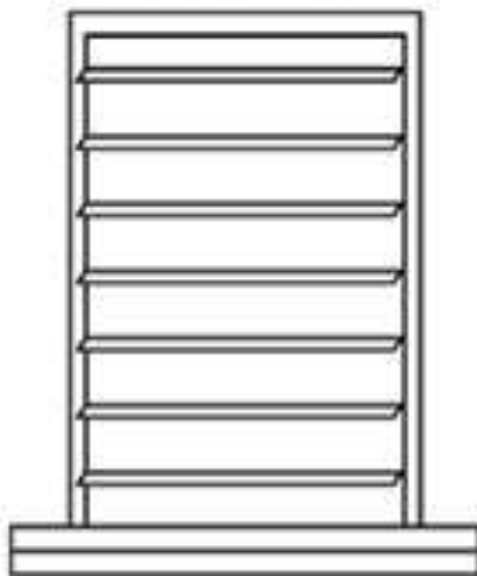

**Up to 95%  
open to breeze**

**Casement window**

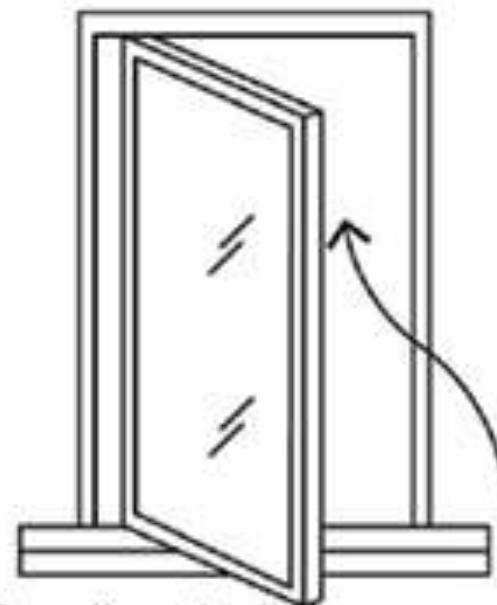

**Re-directs breeze  
through window**

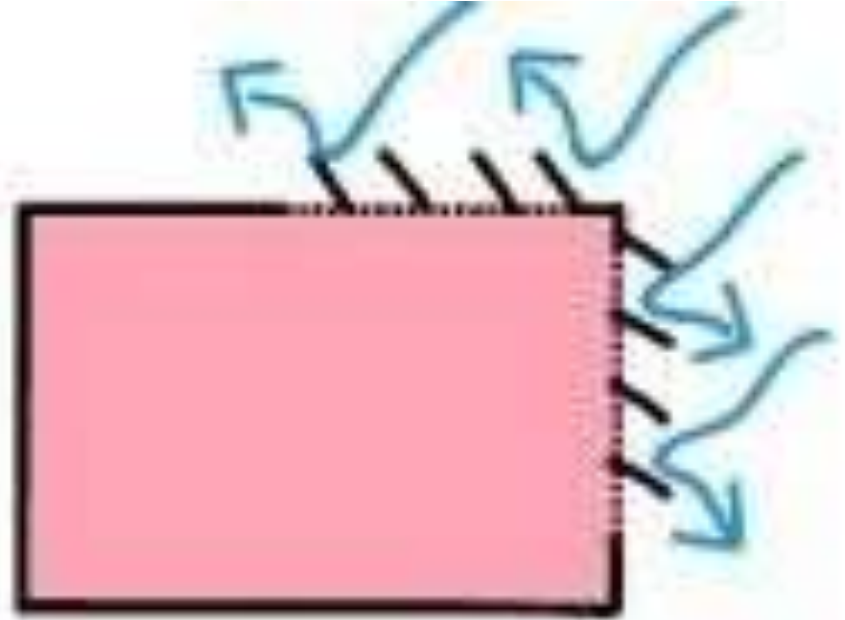
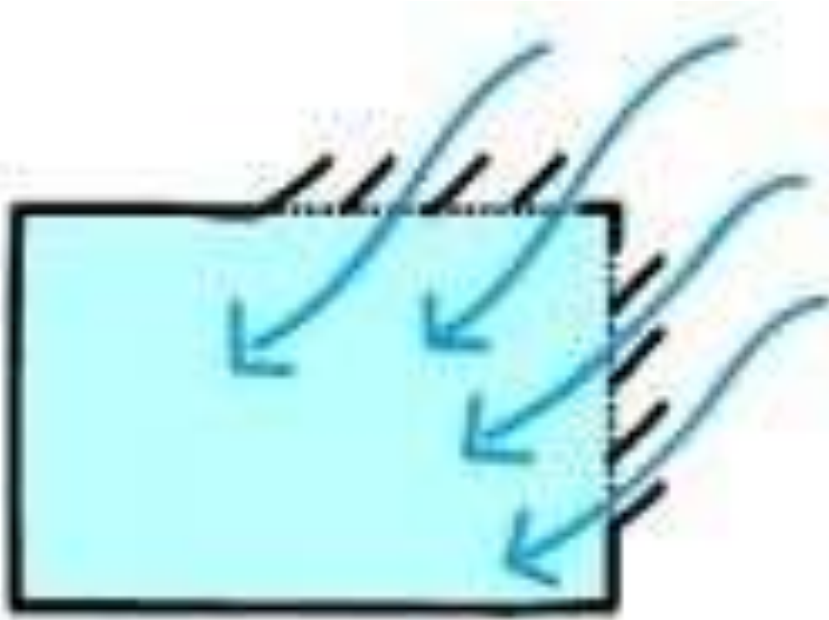

Casement windows should be hinged the right way to direct breezes into the home.

Best

Good

Poor

Poor

Apertures on Same Wall

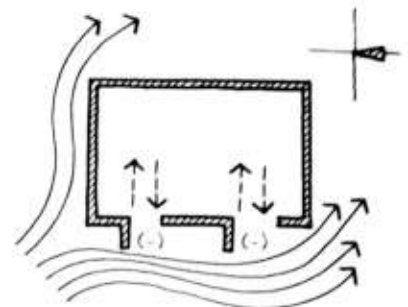
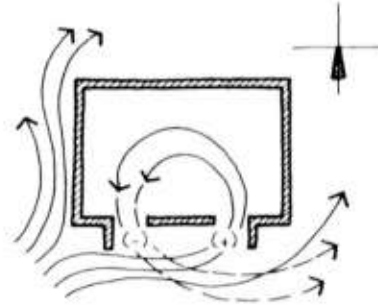
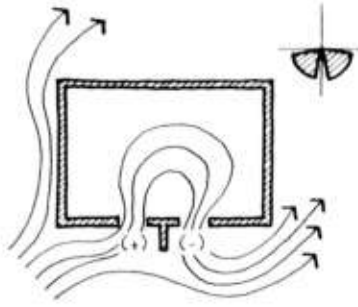
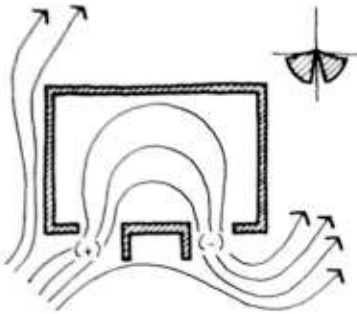

Apertures on Adjacent Walls

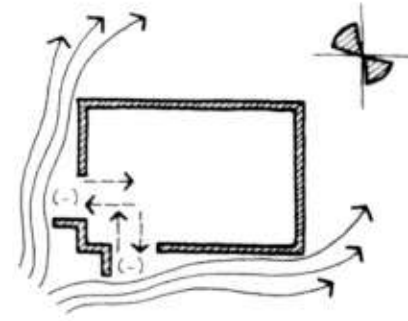
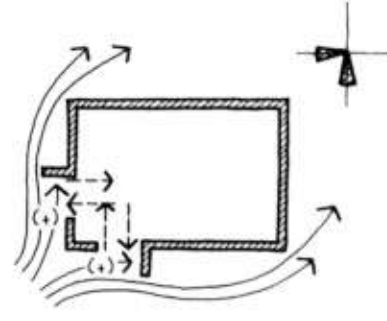
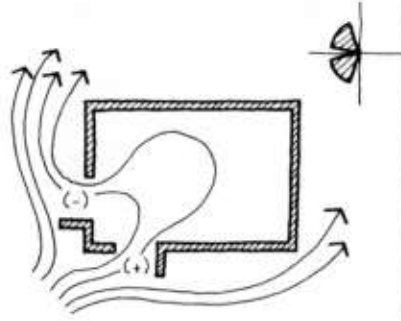
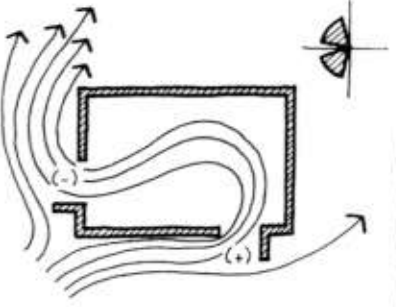
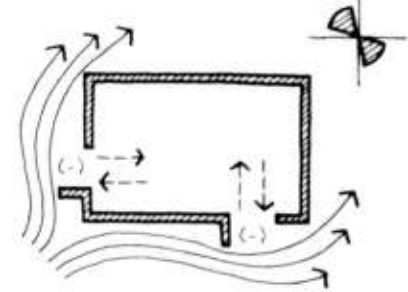
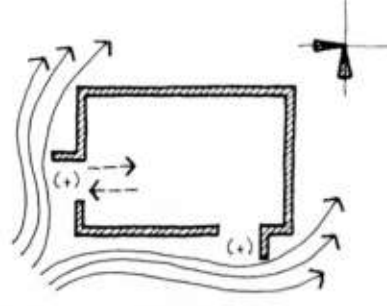
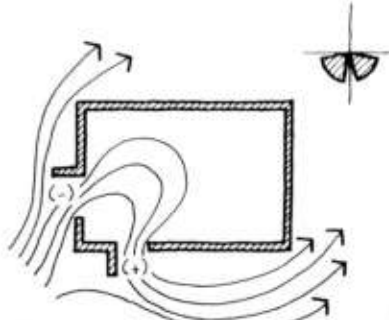
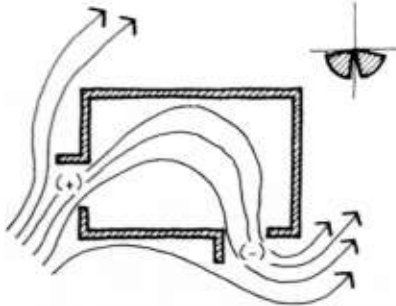

# 4. Convective Air Movement

Convection causes warm air to rise, drawing in cool air

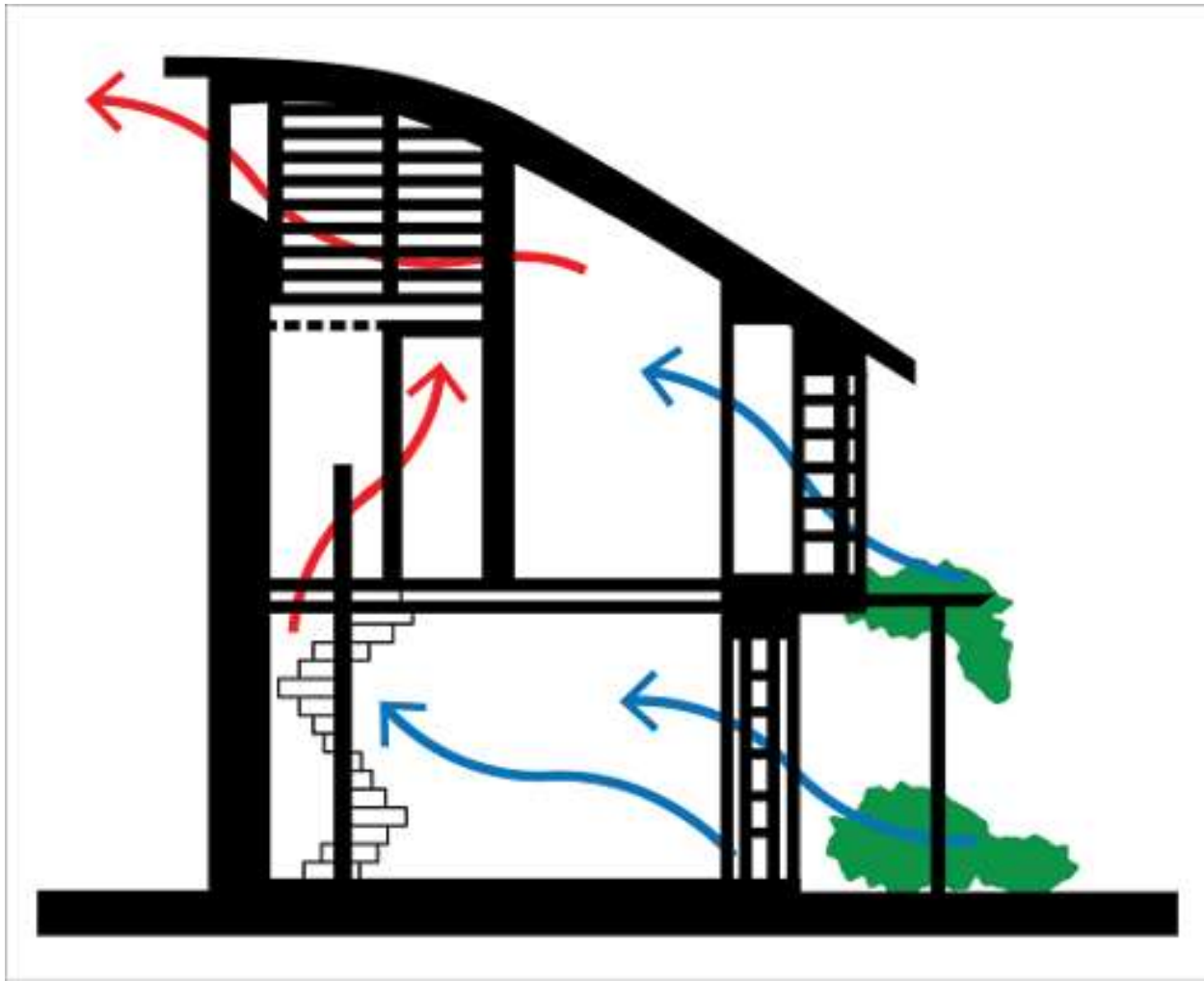

- ∞ Convection plays a leading role in natural ventilation. Hot air rises and escapes through small gaps in the building fabric at the top of the house. As it does so it draws in new cold air through similar gaps at the bottom of the house.
- ∞ It is the largest single cause of heat loss in a home. It requires particular attention when draught proofing a house

Wind air-flow

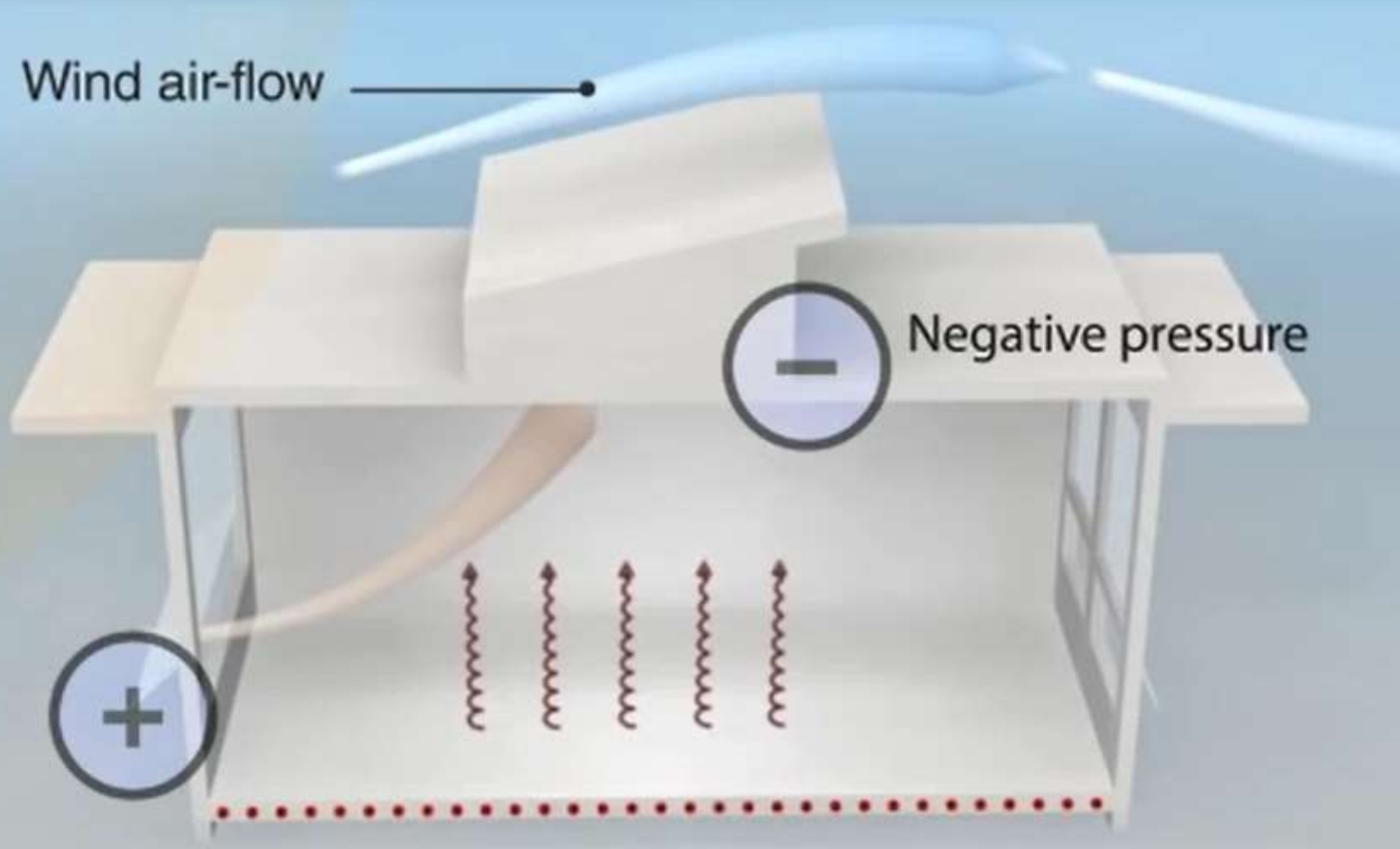

Negative pressure



# 5. Fly Roofs

A fly roof protects a building from radiant heat and encourages cooling breezes in hot humid climates. Well-ventilated roof spaces form a buffer between internal and external areas

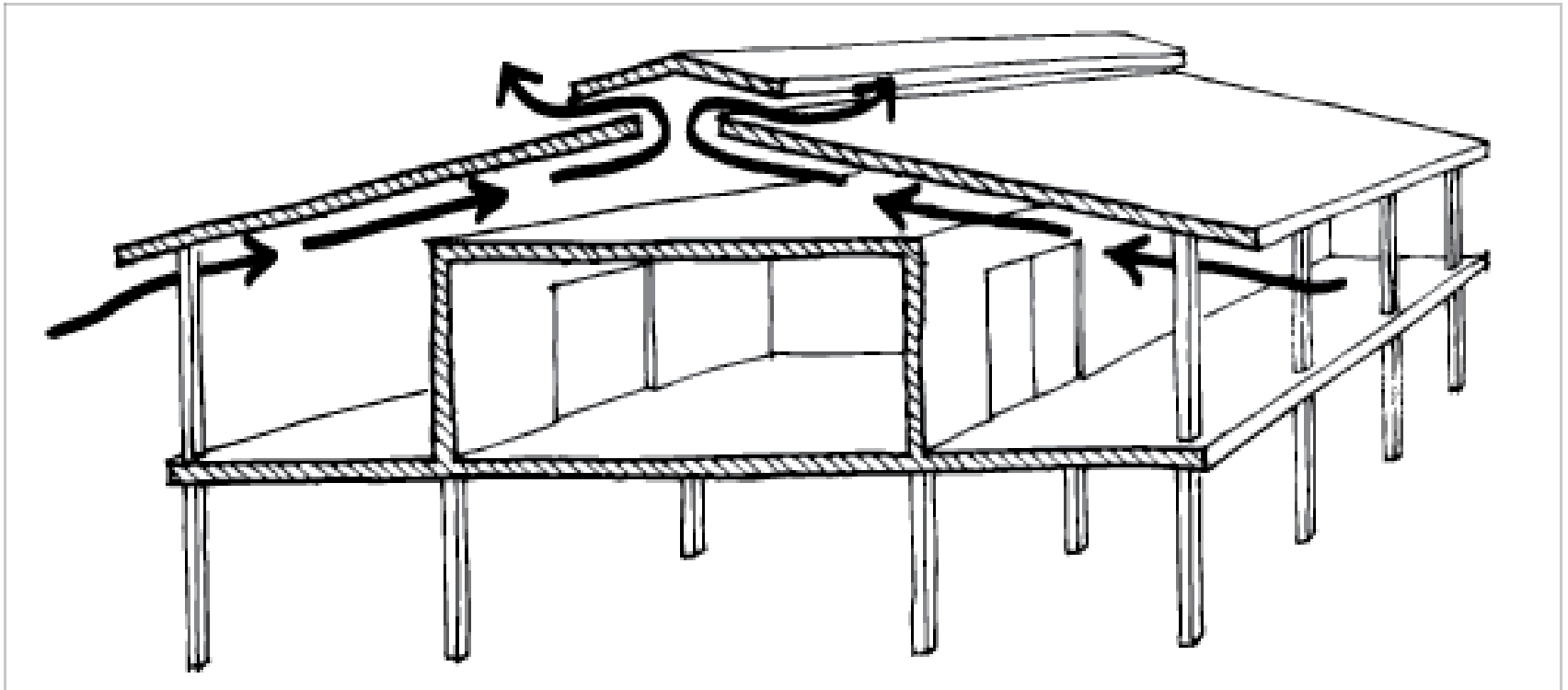



# 6. Earth Coupling

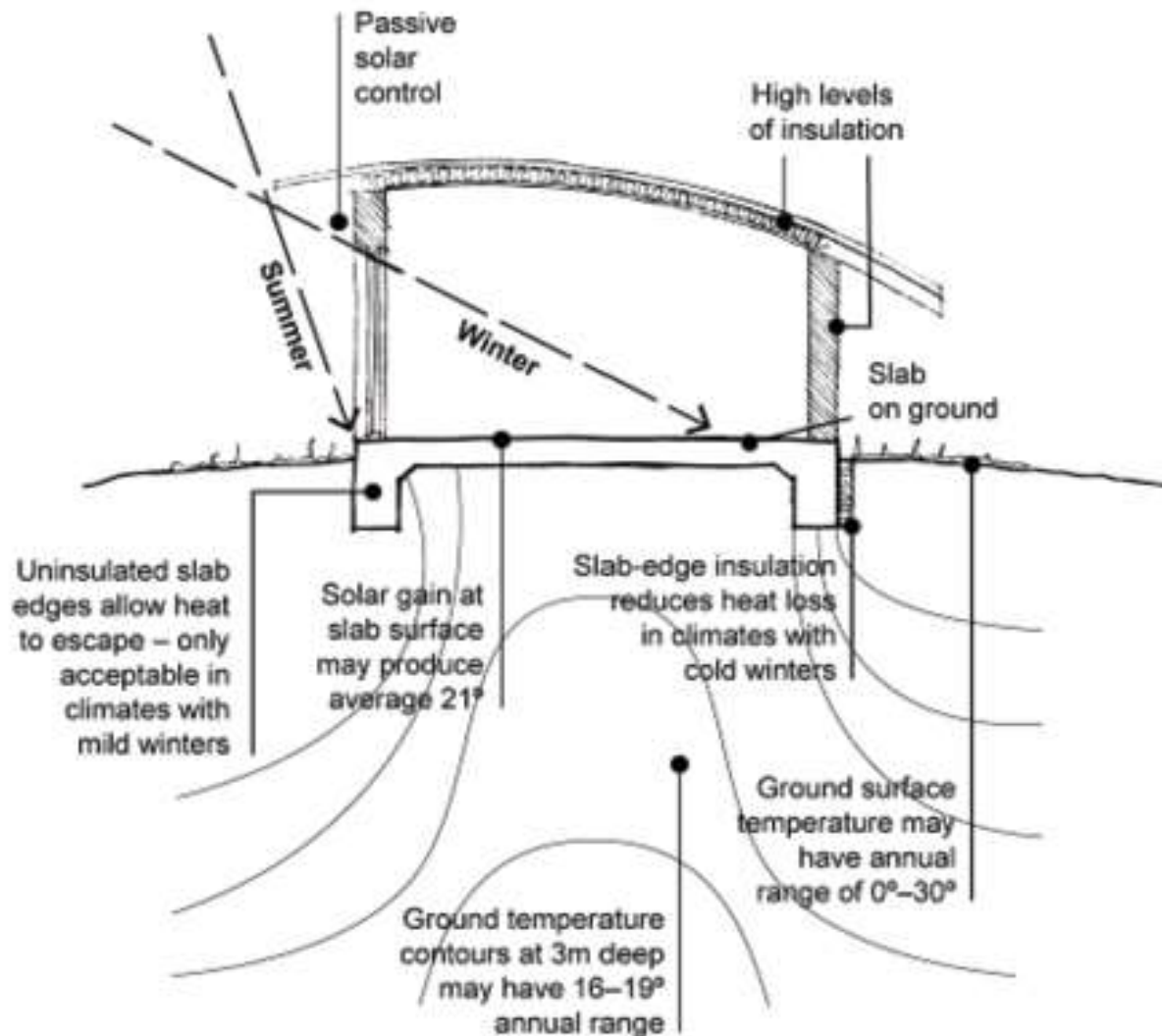

# 7. Plant, Trees & Shrubs to funnel breezes

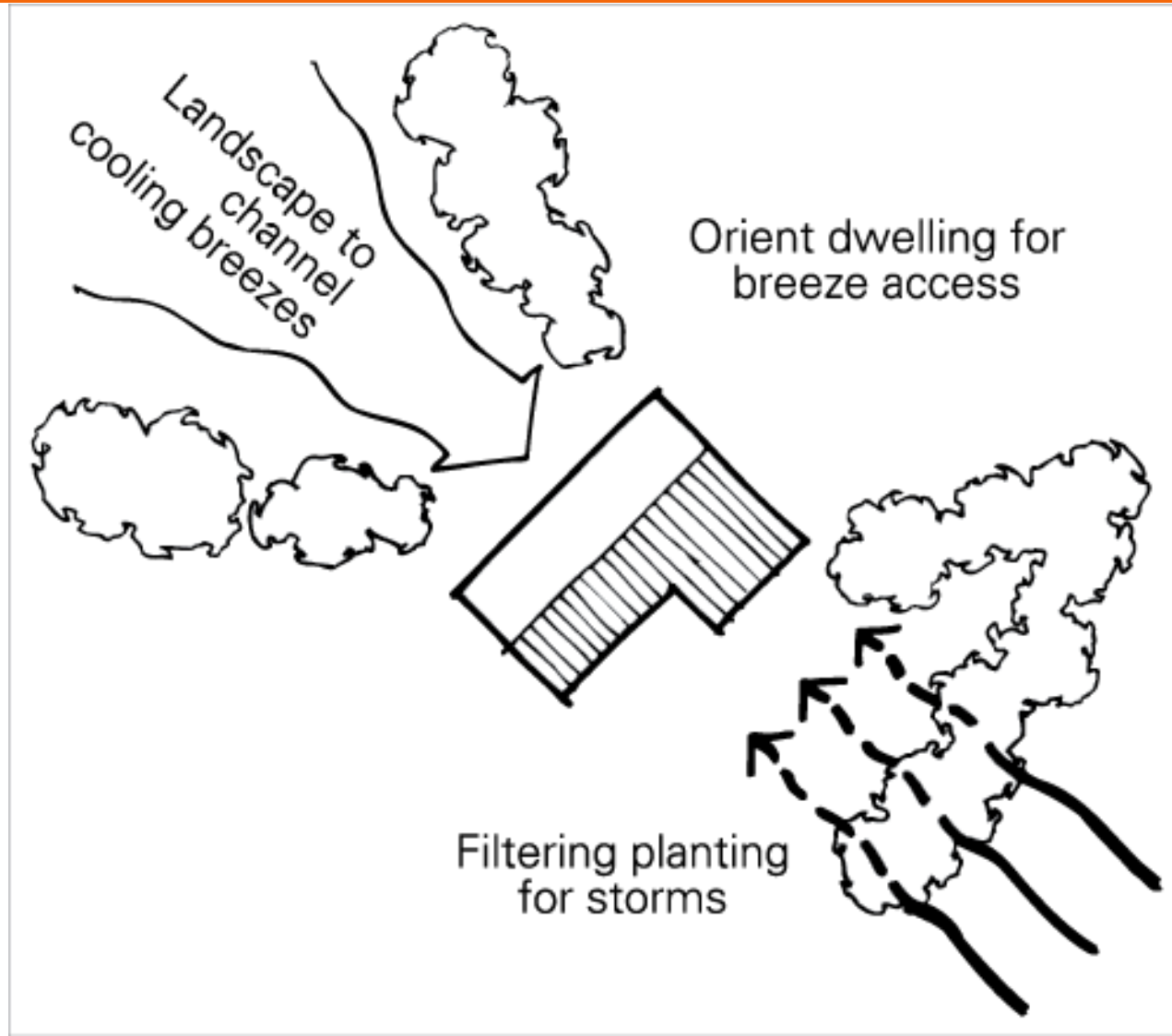

# 8. Evaporative Cooling

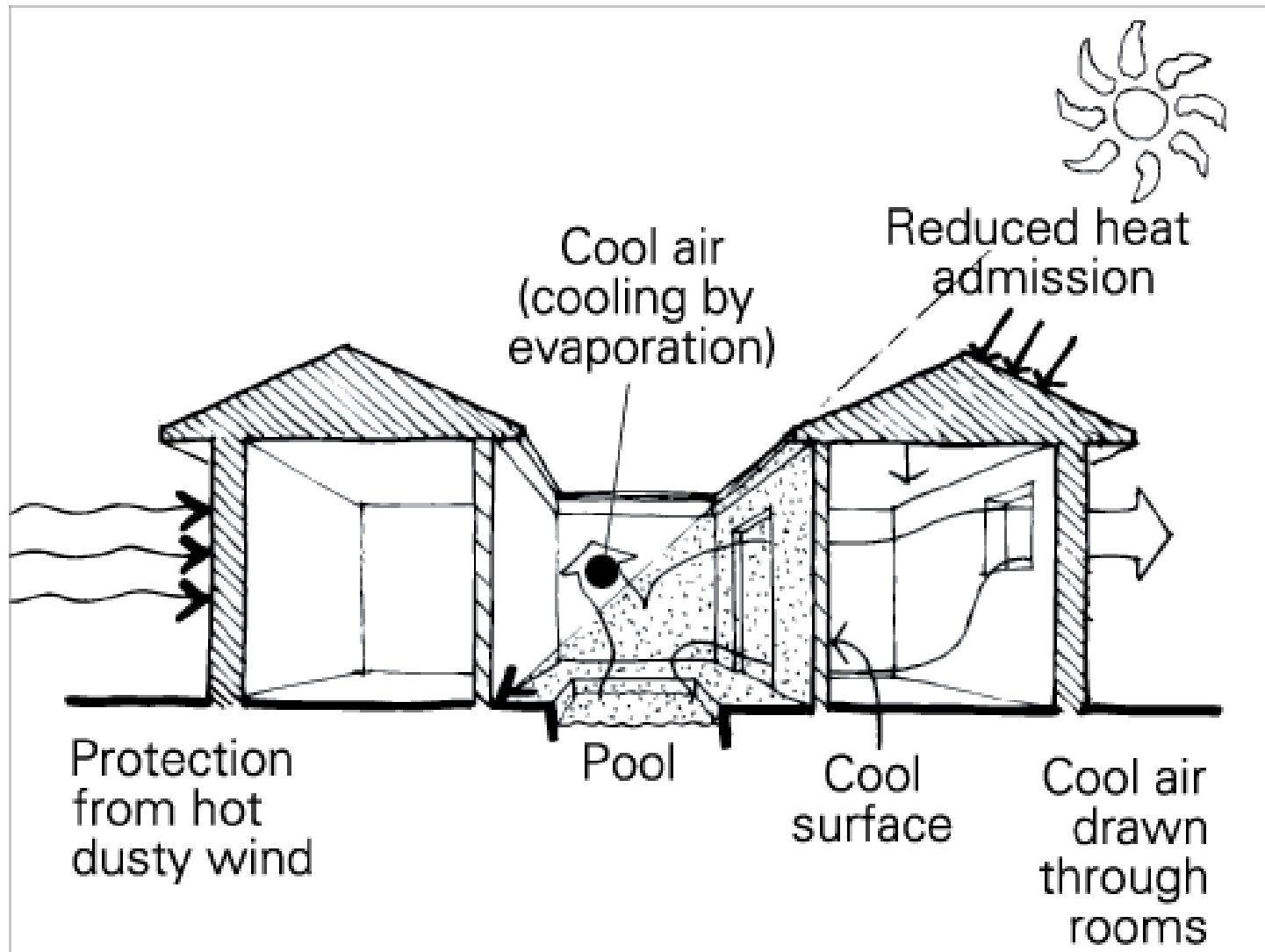

# 9. Sun Shading

- ☞ Heavily insulated walls and roofs need less shading
- ☞ Reduce solar heat gain by recessing windows into the wall
- ☞ Use louvered shades to allow more daylight to enter, while shading windows from direct sunlight.



# Fixed Shading Devices



# 1. Eaves

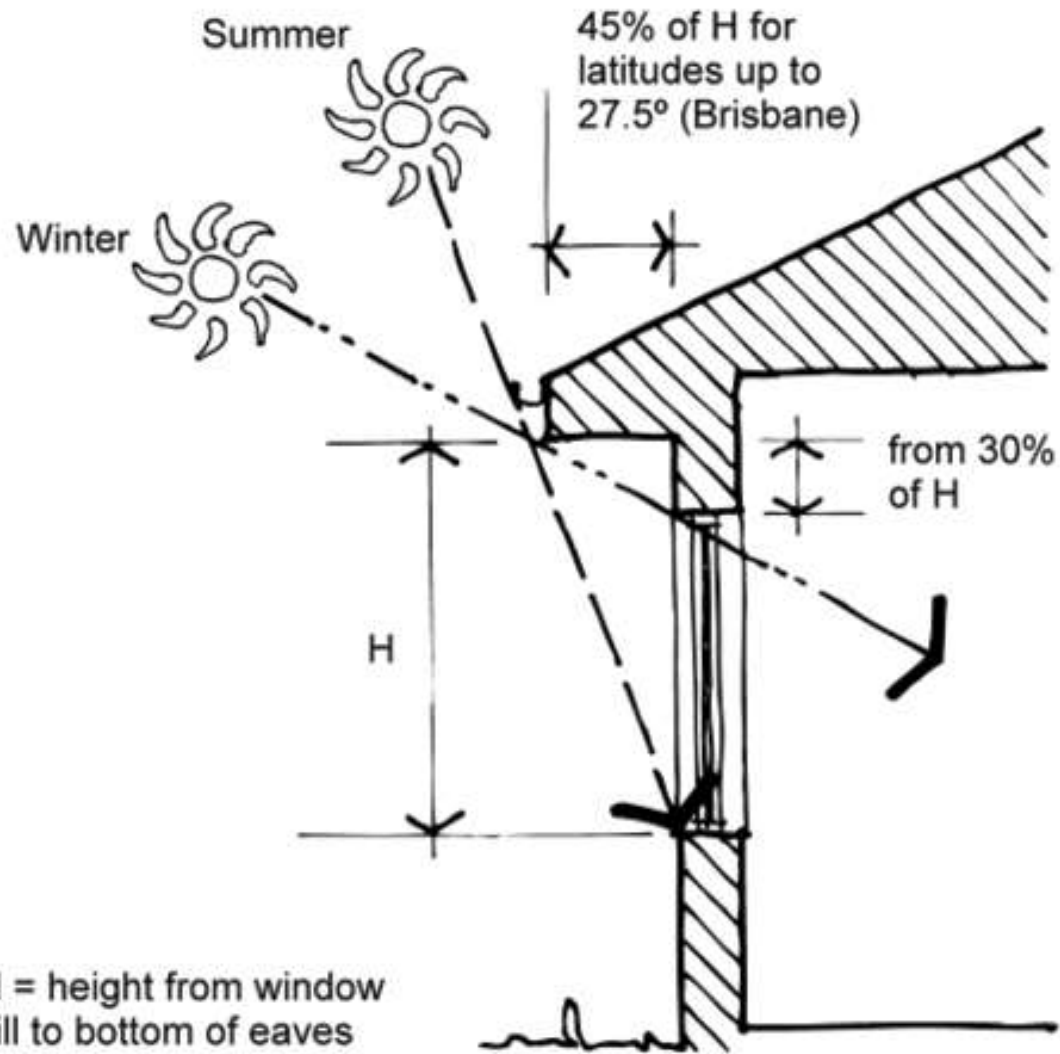

## 2. Horizontal shades

Horizontal shading devices must extend beyond the width of the south-facing opening by the same distance as their outward projection to shade the glass before and after noon

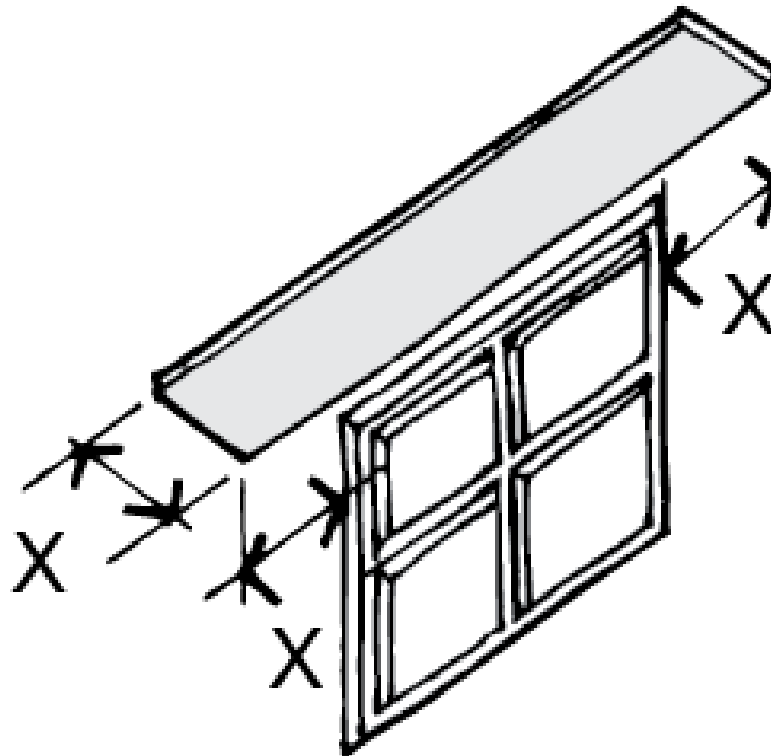

# 3. Louvers

As a rule of thumb, the spacing (S) between fixed horizontal louvers should be 75% of their width (W)

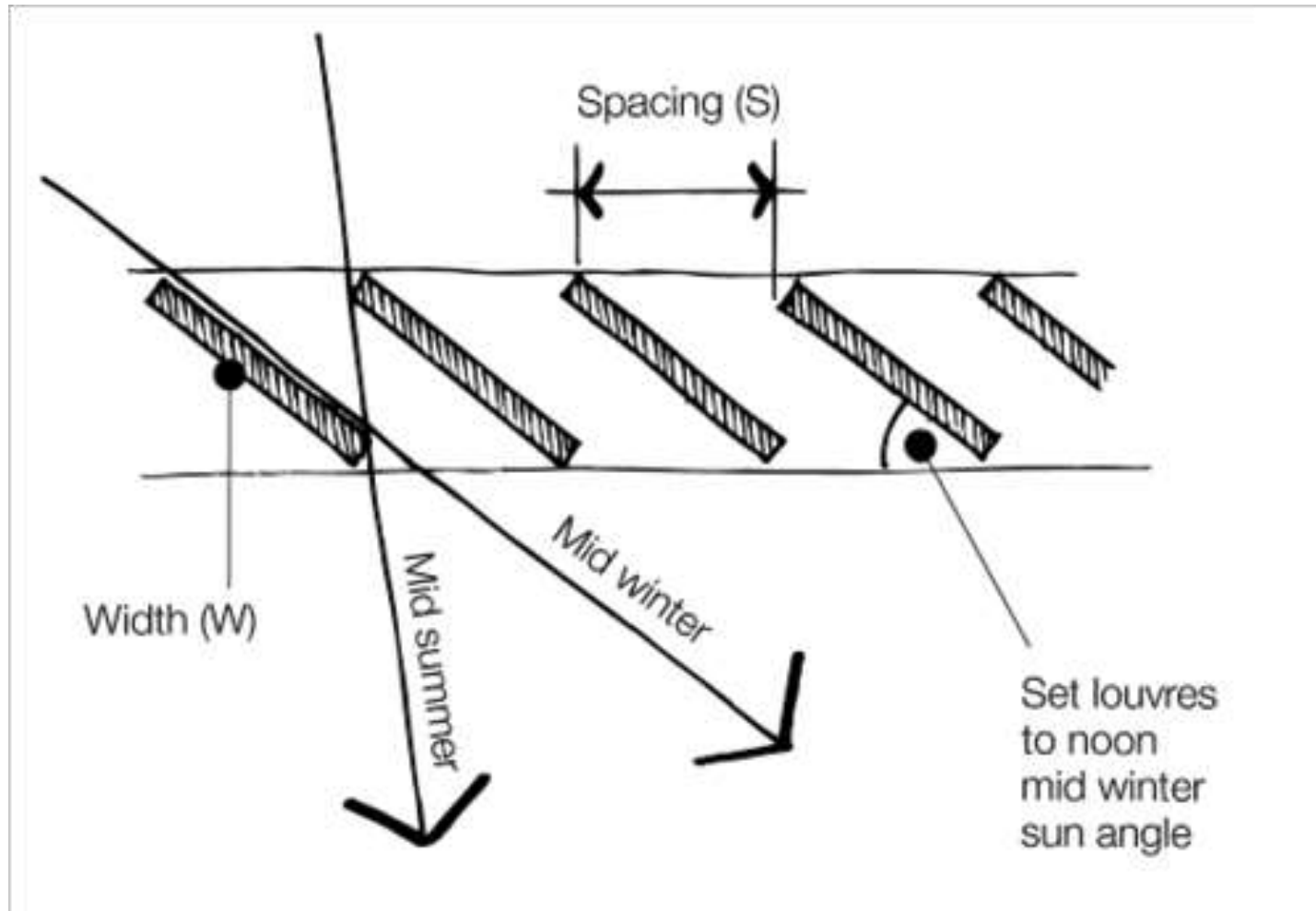



# Louvered Windows



# 4. Pergolas for east and west

West-facing glass and walls are a significant source of heat gain in hotter climates. East-facing glass can be equally problematic. Both east and west require shading in hotter climates

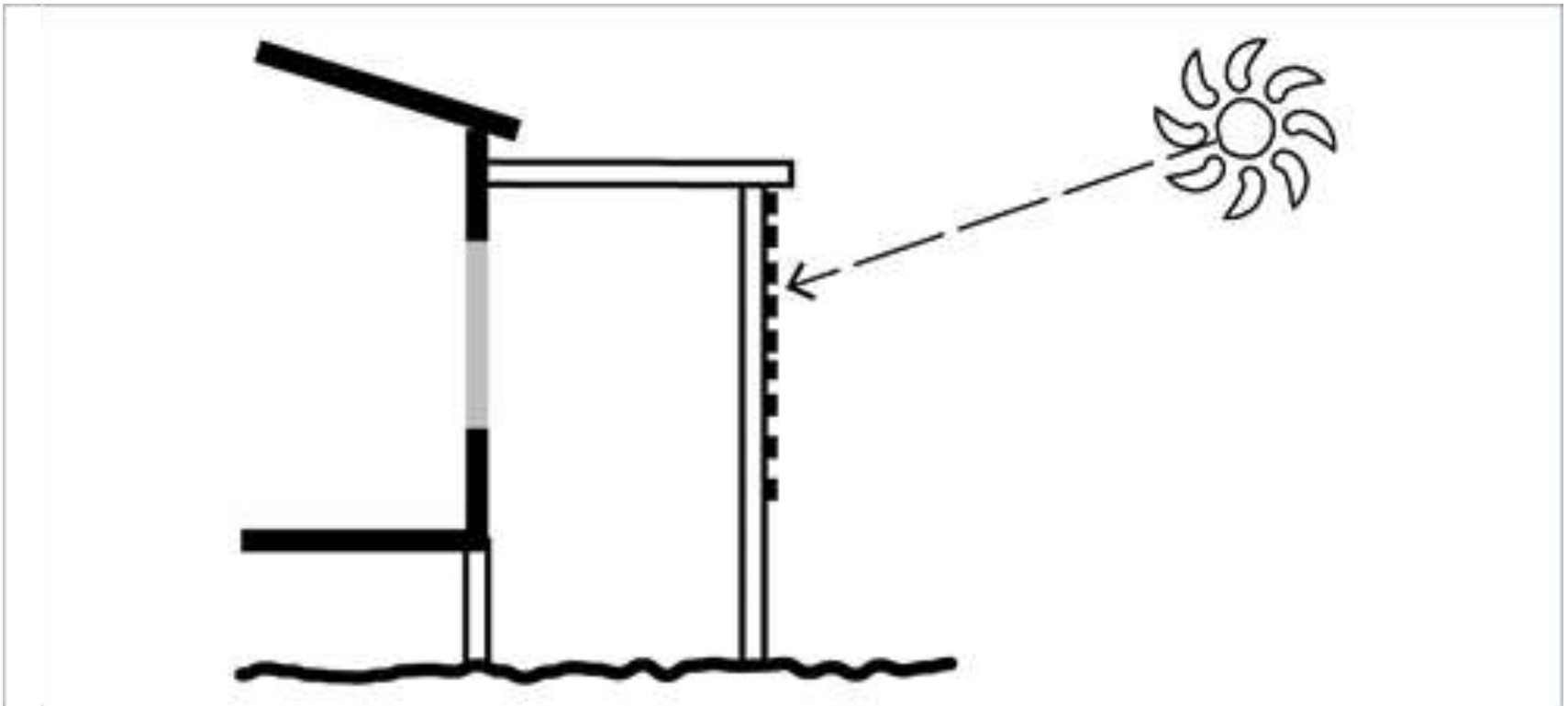

Pergola with vertical screen to block low-angle sun



# Adjustable Shading Devices



# 1. Louvers on South

Adjustable horizontal louver systems and removable shade cloth over pergolas. Shade cloth is a particularly flexible and low cost solution

## **Southern elevations**



## 2. Awnings or roller shutter on East and West

Awnings and roller shutters provide adjustable shading on eastern and western elevations

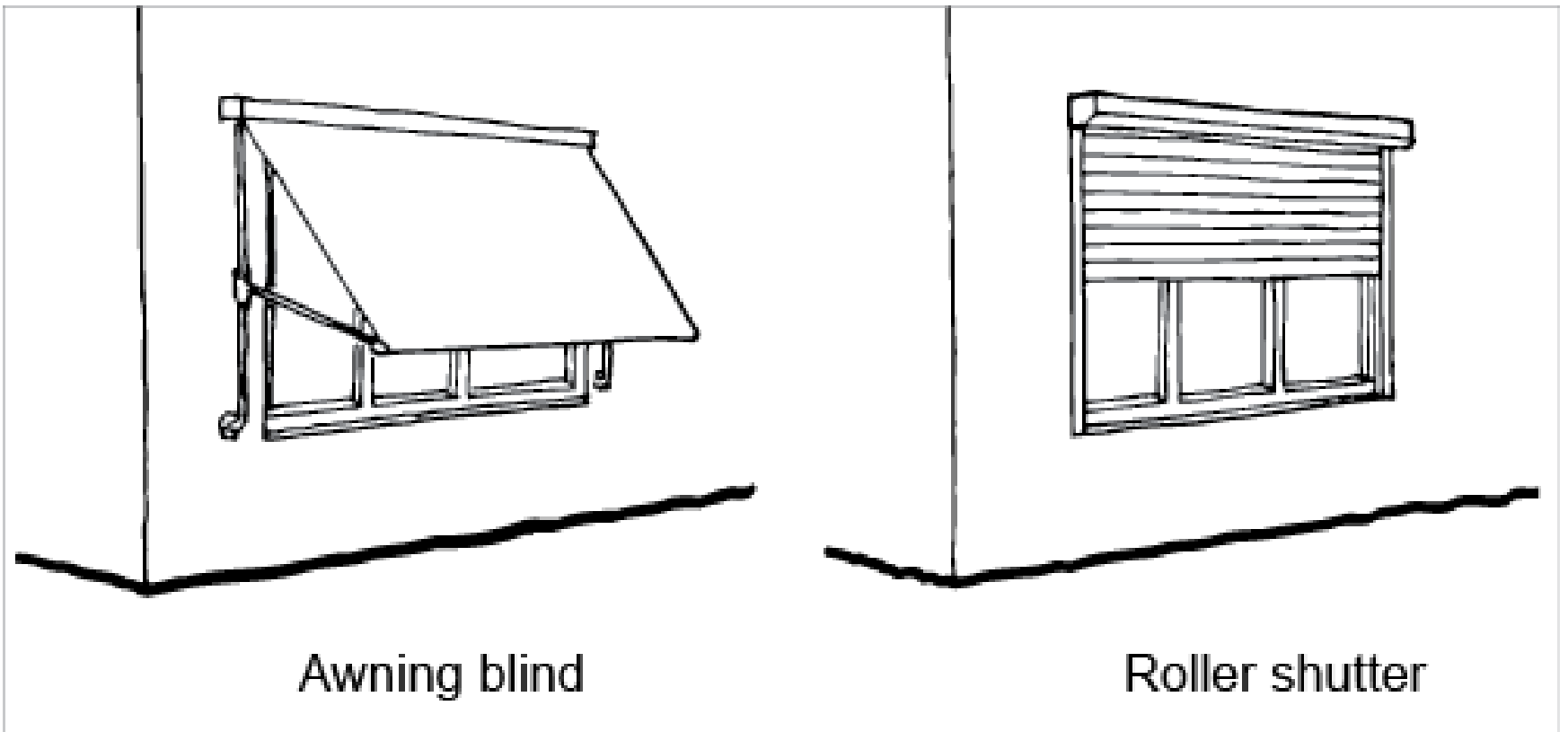

# 3. Cloth on South-East and South-west elevations

Adjustable shading is recommended for these elevations as they receive a combination of high and low angle sun throughout the day



## 4. Shade Screens on Warm humid and warm/mild temperate climates

Use adjustable shade screens or deep overhangs to the east and west. Adjustable shade screens exclude low angle sun the most effectively





# 5. Using plants for shading

Dense planting  
as wind breaks

South facing courtyard  
with moist, cool fernery

Deciduous trees and  
vines to the north.

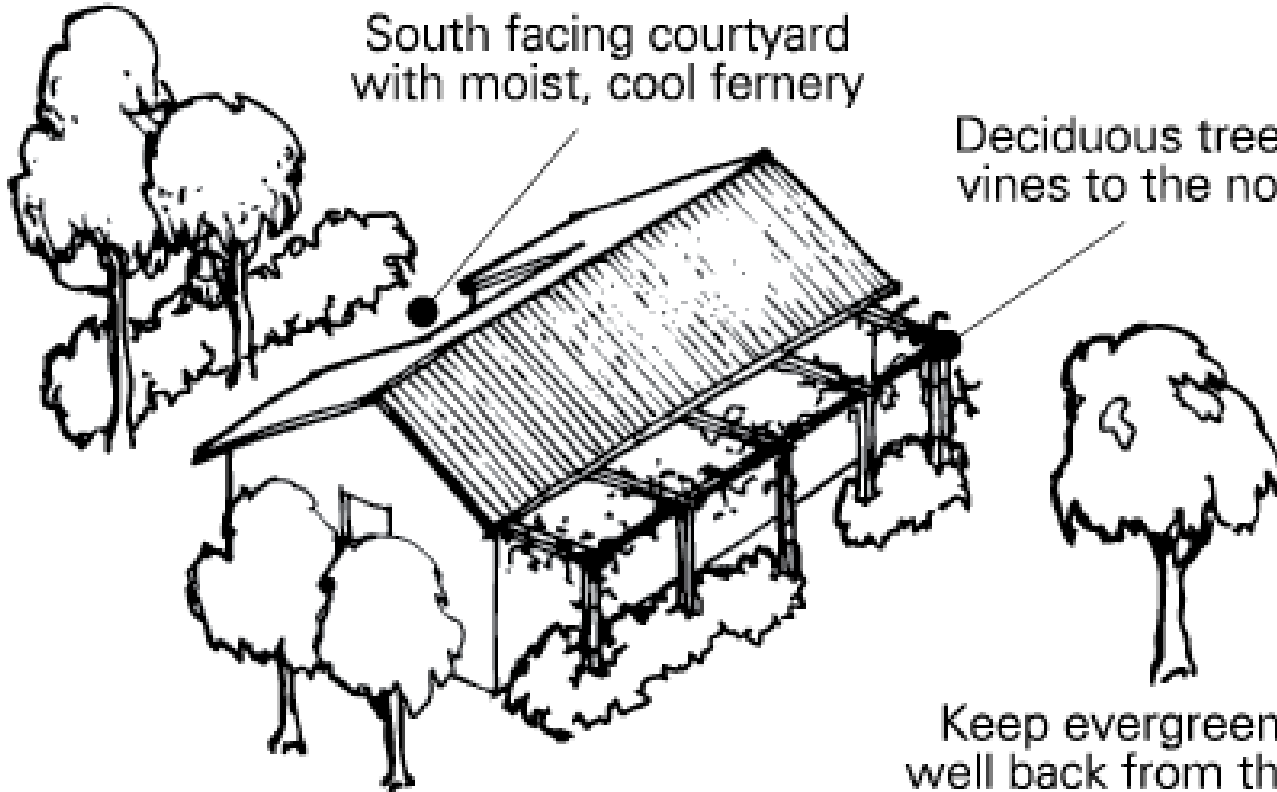

Deciduous trees and shrubs shade  
the east and west walls and windows

Keep evergreen trees  
well back from the house

# FERNERY



# 10. Insulation

- ∞ Insulation acts as a barrier to heat flow and is essential for keeping your home warm in winter and cool in summer.
- ∞ Insulation can help with weatherproofing and eliminate moisture problems such as condensation; some types of insulation also have soundproofing qualities.
- ∞ The most economical time to install insulation is during construction.
- ∞ Insulation can be added to cavity brick walls and other types of walls, roof and ceiling, floors
- ∞ Some insulation materials are as follows: rock wool, glass wool, Polyester etc.

## Summer heat gains

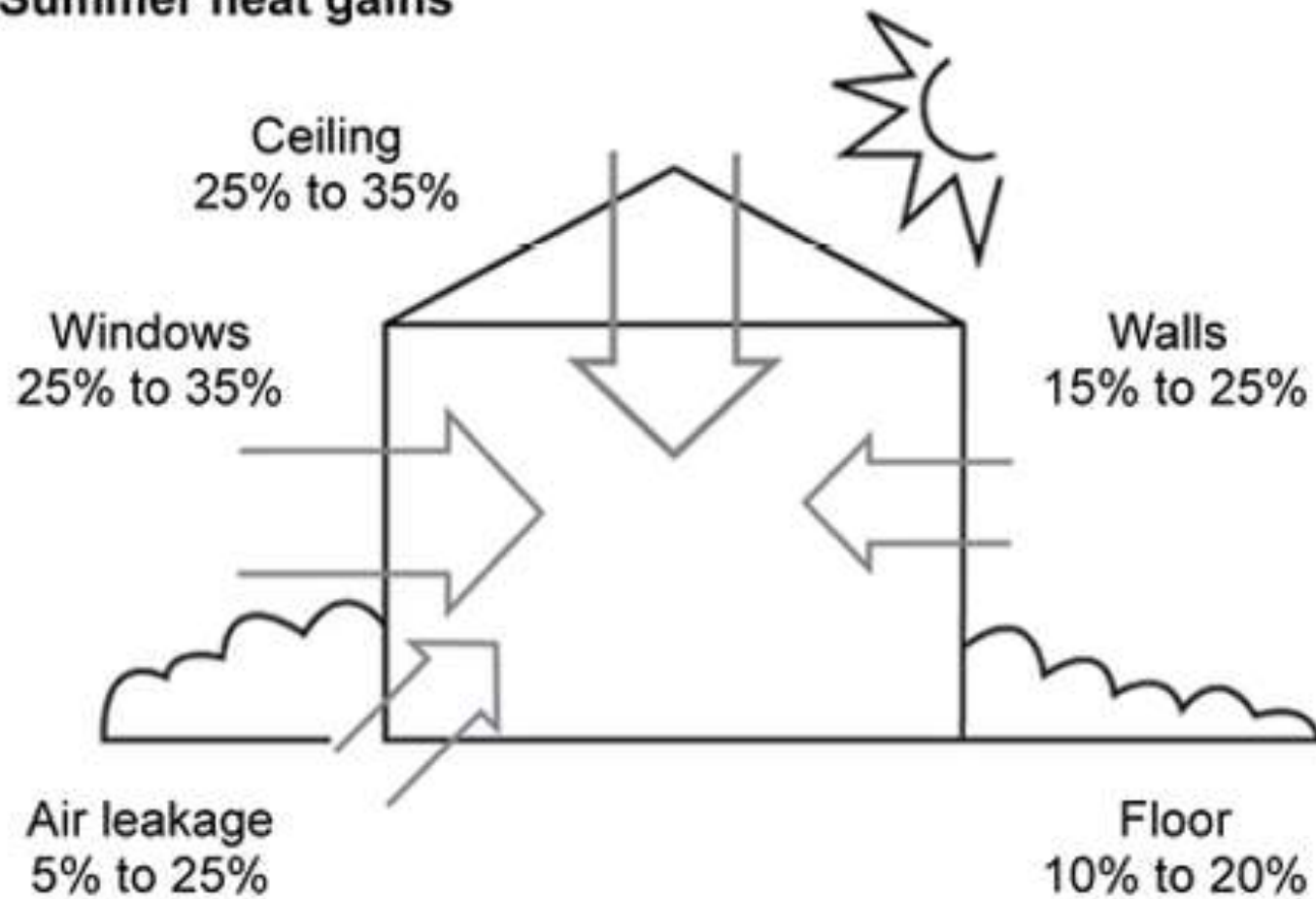

# 11. Roof Spray

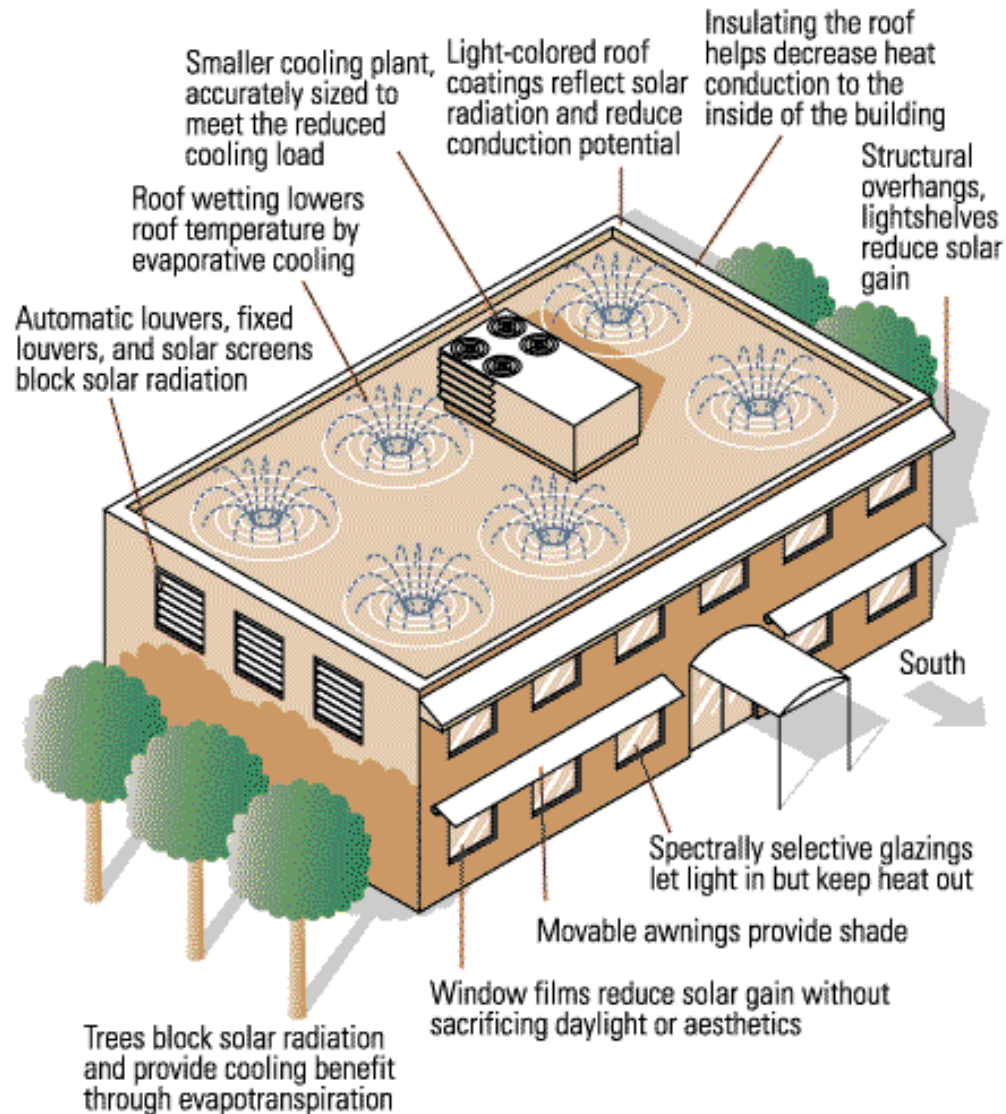

# 12. Wind Tower

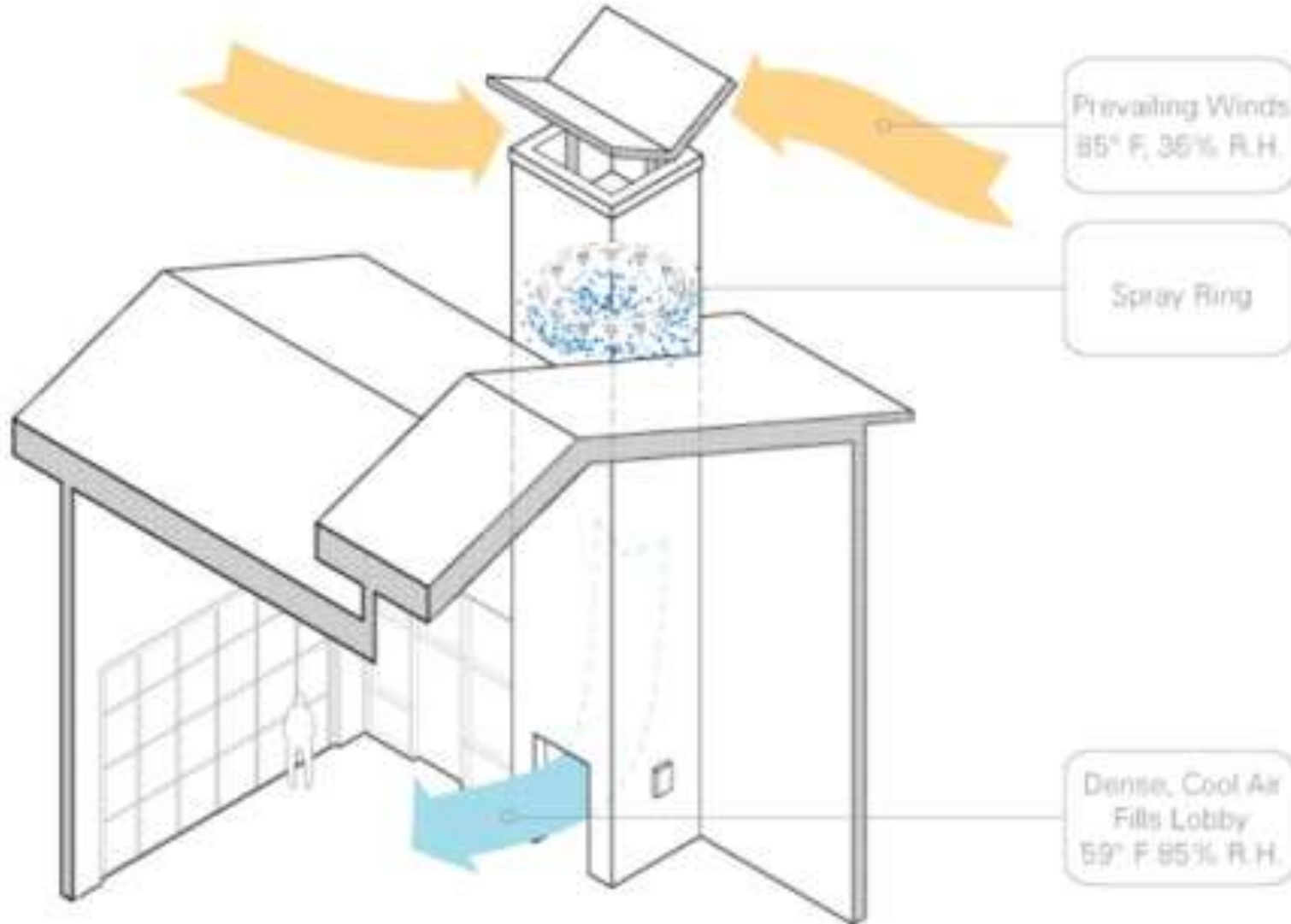

# 13. Roof Color

- Using lighter colored roofs reflects sunlight and reduces the heat gain

