

Full Adder

Sir. Muhammad Amin

Name = Farhan Akhtar

ID # 15554

LAB# 3

FULL ADDER

AIM:

Design and verify the logic circuit of Half-subtractor using logic gate.

OBJECTIVES:

- To understand the principle of binary addition.
- To understand full adder concept.
- Use truth table and Boolean Algebra theorems in simplifying a circuit design.
- To implement full adder circuit using logic gates.

PROCEDURE:

- Collect the components necessary to accomplish this experiment.
- Plug the IC chip into the breadboard
- Connect the supply voltage and ground lines to the chips. PIN7 = Ground and PIN14 = +5V.
- According to the pin diagram of each IC mentioned above, make the connections according to circuit diagram.
- Connect the inputs of the gate to the input switches of the LED.
- Connect the output of the gate to the output LEDs.
- Once all connections have been done, turn on the power switch of the breadboard
- Operate the switches and fill in the truth table (Write "1" if LED is ON and "0" if LED is OFF).
- Apply the various combination of inputs according to the truth table and observe the condition of Output LEDs.

FULL ADDER:

Full adder is a logical circuit that performs an addition operation on three binary digits. The full adder produces a sum and carry value, which are both binary digits. It can be combined with other full adders or work on its own.

OBSERVATION TABLE:

A	B	Carry-in	Sum (S)	Carry- Out
0	0	0	0	0
0	0	1	1	0
0	1	0	1	0
0	1	1	0	1
1	0	0	1	0
1	0	1	0	1
1	1	0	0	1
1	1	1	1	1

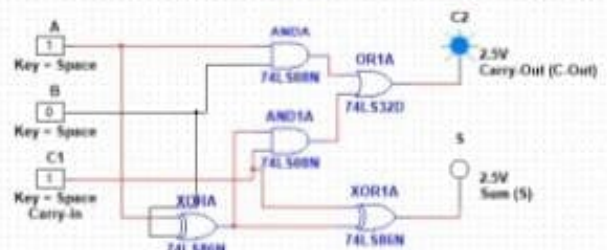
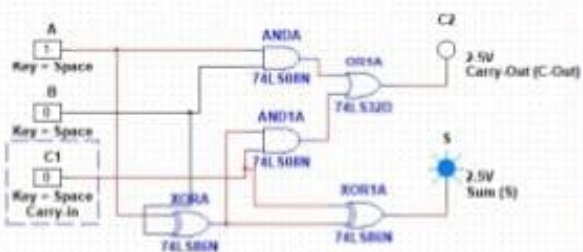
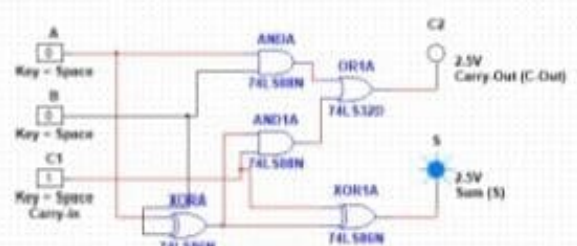
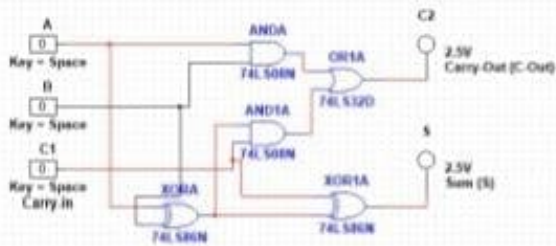

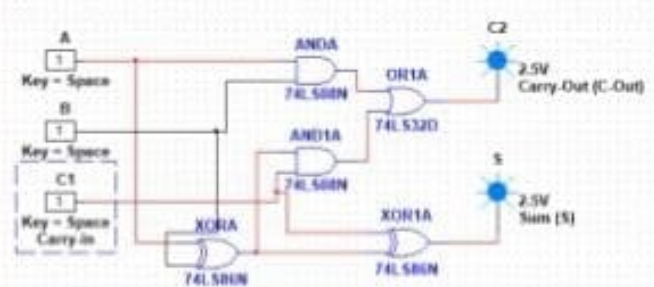
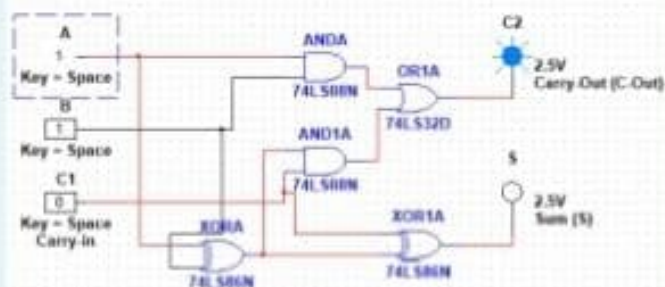
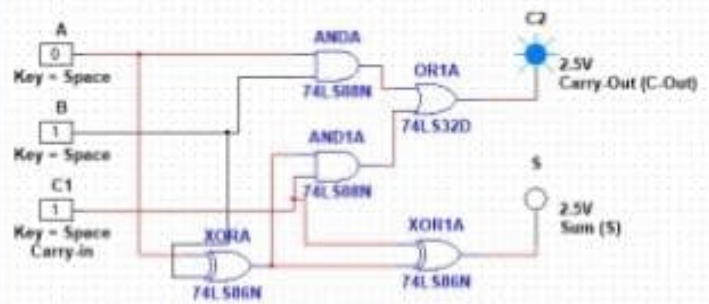
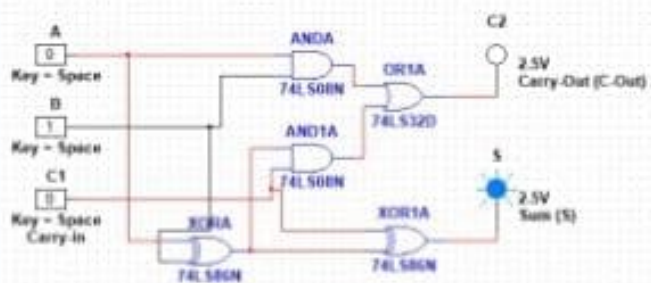

RESULTS AND ANALYSIS:

Full Adder: Verified the truth table of Full Adder as $S = 1$ i.e. LED which is connected to S terminal glows when inputs are A, B, Ci Verified the truth table of Full Adder as $Co = 1$ i.e. LED which is connected to Co terminal glows when inputs are A, B, Co.

CONCLUSION:

>>>> To add two bits, we require one XOR gate (IC 7486) to generate Sum and one AND (IC 7408) to generate carry.

- > > > To add three bits, we require two half adders.