

Name : Irfan ullah

ID : 15431

Assignment : no 7

Subject : Digital Logic Design

Course code(CS) : CSC-201

Program : BC (CS)

Assignment No 7

Name • Irfan ulah

ID • 15431

Subject • DLD

Program • Bc(cs)

Q1:-

A register is an electronic device consists of a series of flip-flops to store data bits and moving the data bits. The length of the stored binary word depends on the number of flip-flops that make up the register.

Q2:-

The storage capacity of a register that can retain one byte of data is 8 bits. This particular register will contain be an 8 stage shift register.

Q31

The Shift Capacity of a register permits to store and make data from one stage to another withing into, out of registers.

Q42

Since the Shift register is initially cleared.

Initially	0	0	0	0
CLK ₁	1	0	0	0
CLK ₂	1	1	0	0
CLK ₃	0	1	1	0

Q5:

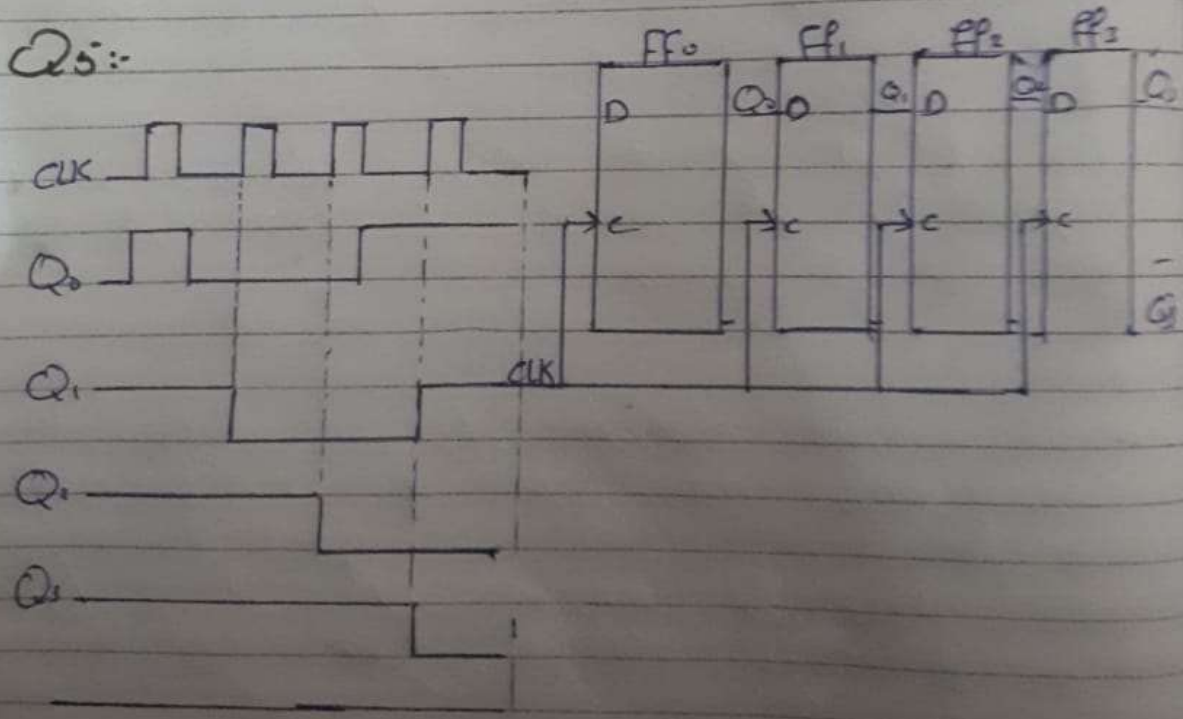

Q6:

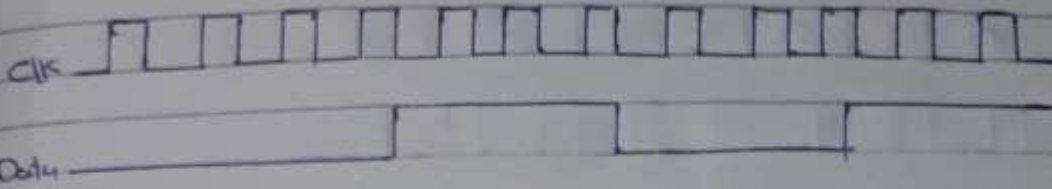

Initially 110001110000
 CLK1 011000110000
 CLK2 001100011100
 CLK3 000110001110
 CLK4 000010001111
 CLK5 100001100011
 CLK6 110000110001
 CLK7 011100001100
 CLK8 001110000110
 CLK9 000111000011
 CLK10 100011100001
 CLK11 110001110000
 CLK12 011000111000

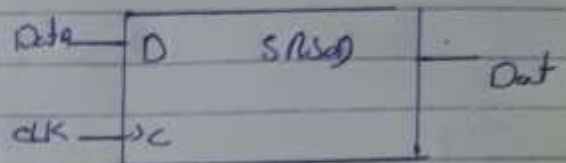

Q7:

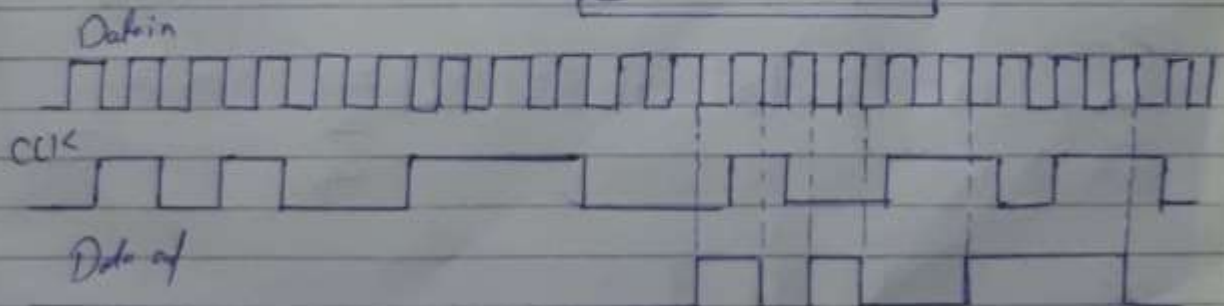
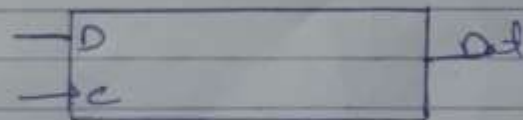

Q8:

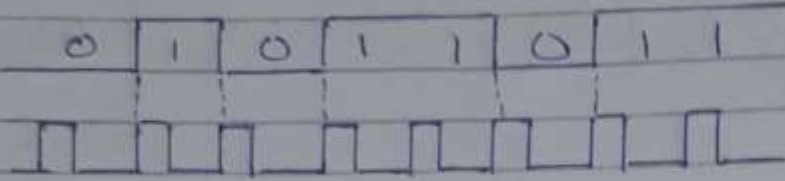

The Data bits stored are

11011010 (a)

Q9:

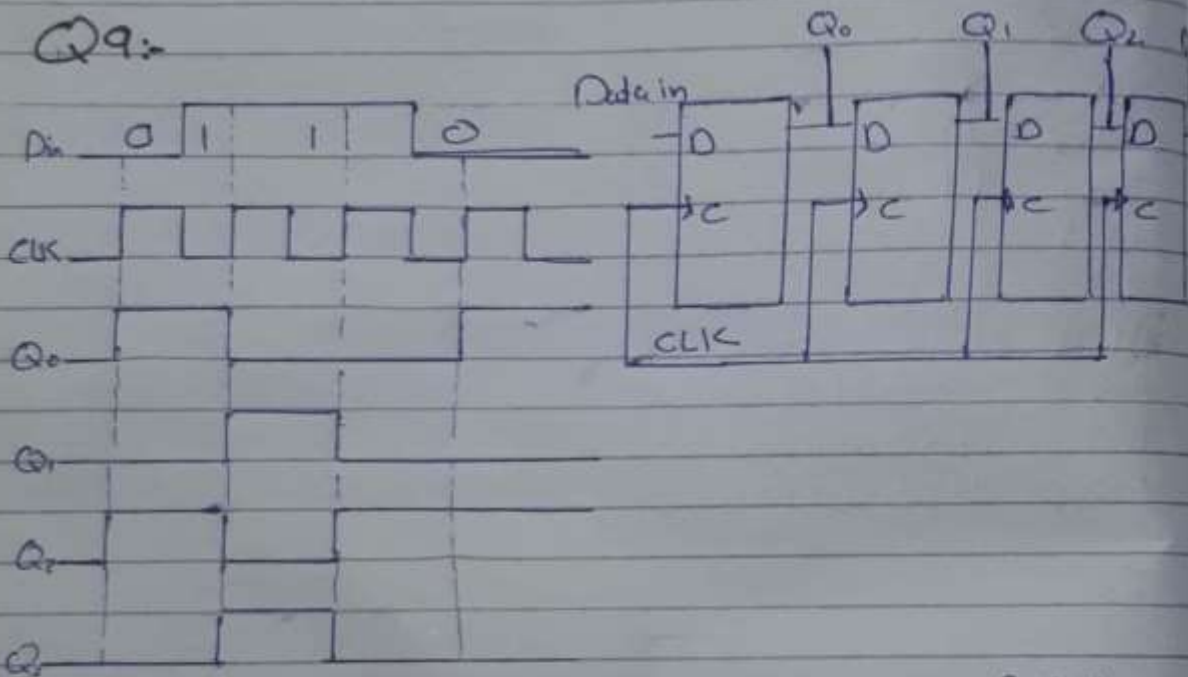

Q10:

