

Name	Asim Ali
ID	7763
Sec	C - 8th Summer
Subject	Structure Analysis 2
Submitted to	Engr. Adeed Khan
Exam type	Final Exam Summer (2020)
Purpose	Improvement for CGPA.
Date:	25-September-2020

* INU PESHAWAR *

(1)

Q. NO 1

Analyze the beam shown in Figure 1 by stiffness method. Assume EI is constant

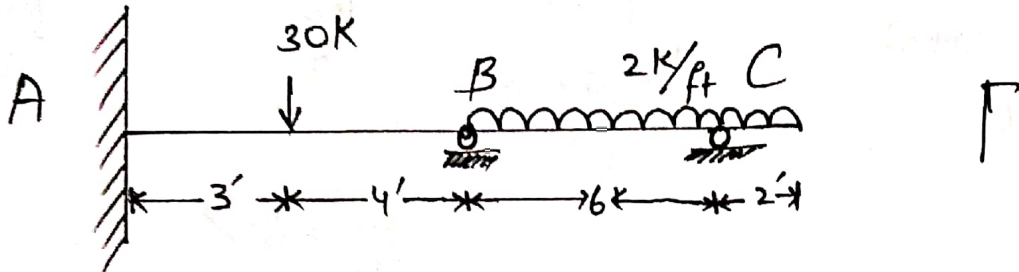

Figure 1

Step 1:

$K.I = 2^\circ$ (Neglecting Axial Effects)

Step 2:

Select the unknown joint displacement

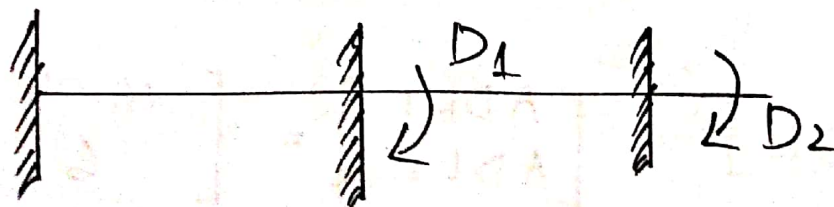
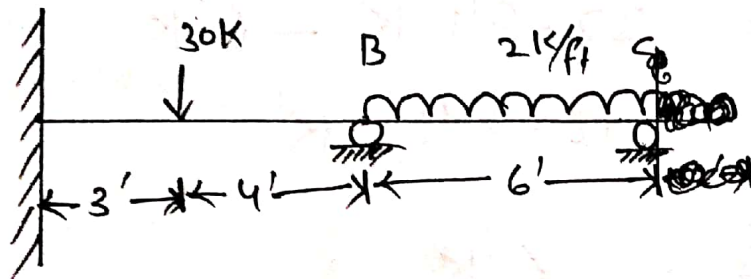

$$[D] = \begin{bmatrix} D_1 \\ D_2 \end{bmatrix} = \begin{bmatrix} ? \\ ? \end{bmatrix}, \quad [AD] = \begin{bmatrix} AD_1 \\ AD_2 \end{bmatrix} = \begin{bmatrix} 0 \\ 4 \end{bmatrix}$$

Step 3: Compute [ADL] matrix.

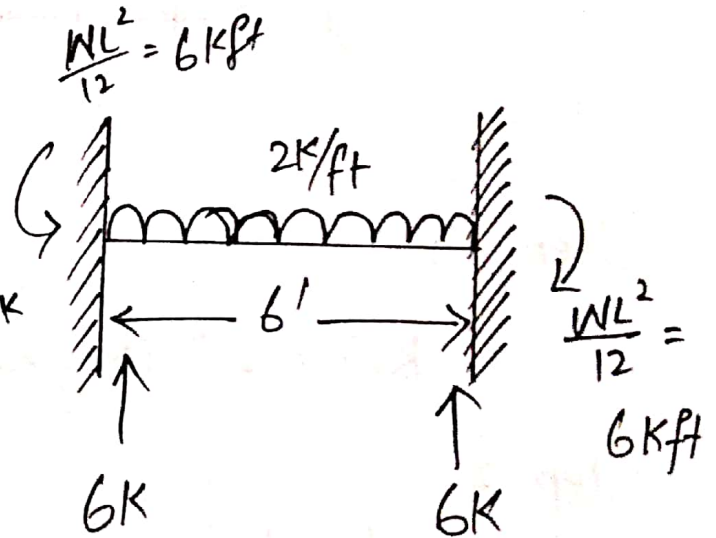
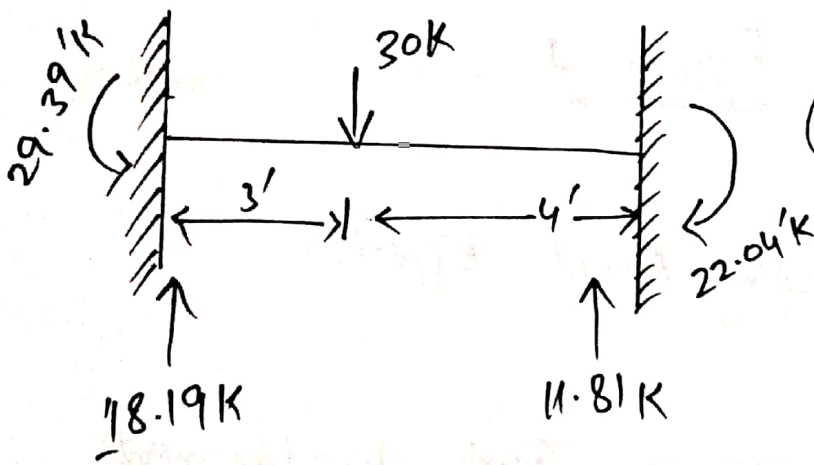
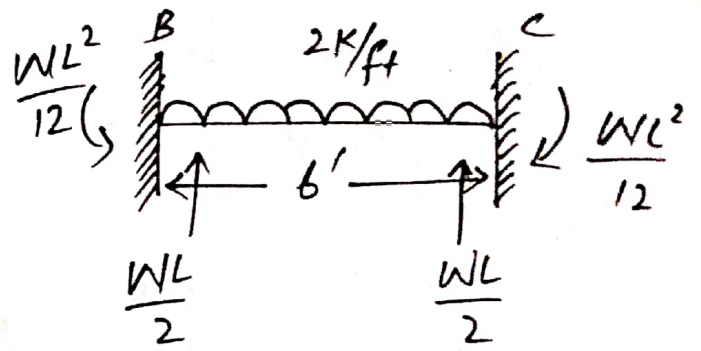
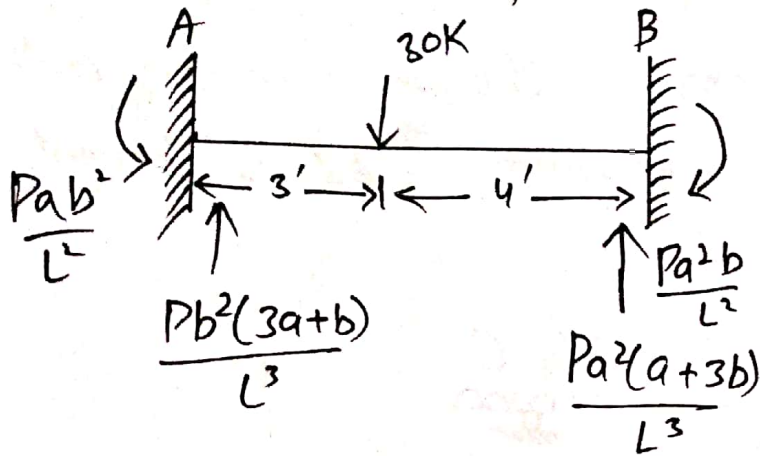

$$ADL_1 = 22.04'K - 6'K$$

$$ADL_1 = 16.04'K$$

$$ADL_2 = 6'K$$

So

$$[ADL] = \begin{bmatrix} ADL_1 \\ ADL_2 \end{bmatrix} = \begin{bmatrix} 16.04 \\ 6 \end{bmatrix}$$

Step #04

(3)

Compute [s] matrix

(i)

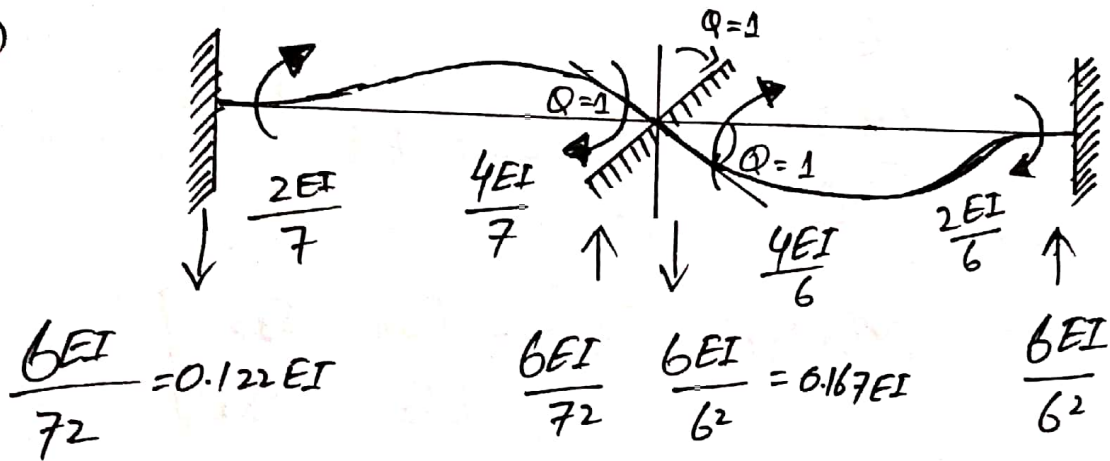

When $D_1 = 1$, $D_2 = 0$

$$S_{11} = \frac{4EI}{7} + \frac{4EI}{6} = 1.238 EI$$

$$S_{21} = \frac{2EI}{6} = 0.333 EI$$

(ii) When $D_1 = 0$, $D_2 = 1$

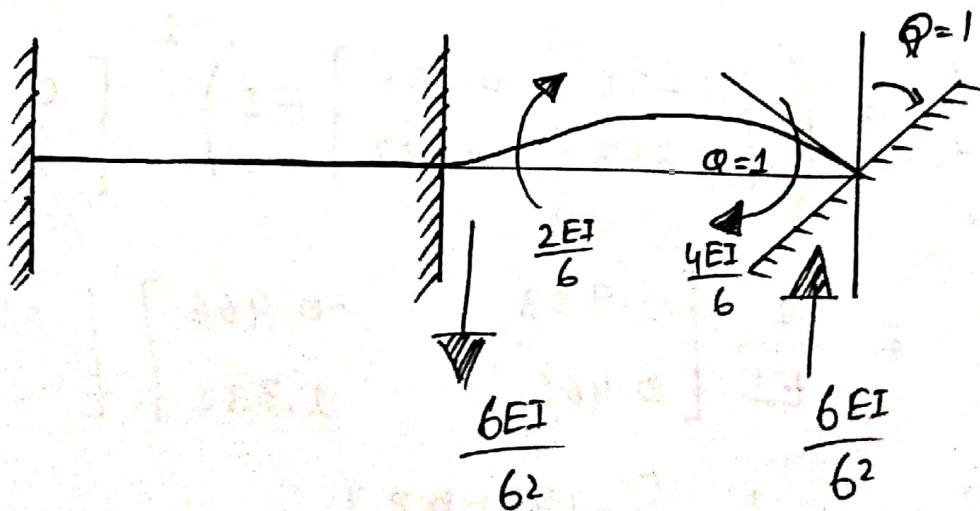

(4)

$$S_{12} = \frac{2EI}{6} = 0.333 EI$$

$$S_{22} = \frac{4EI}{6} = 0.667 EI$$

Stiffness Matrix $[S] = \begin{bmatrix} S_{11} & S_{12} \\ S_{21} & S_{22} \end{bmatrix}$

$$[S] = \begin{bmatrix} 1.238 & 0.333 \\ 0.333 & 0.667 \end{bmatrix} EI$$

Step # 05 Compute the values of D_1 & D_2 .

$$[AD] = [ADL] + [S][D]$$

$$[D] = [S]^{-1} [AD - ADL]$$

$$[D] = \left(\begin{bmatrix} 1.238 & 0.333 \\ 0.333 & 0.667 \end{bmatrix} EI \right)^{-1} \begin{bmatrix} 0 - (16.04) \\ 4 - (6) \end{bmatrix}$$

$$= \frac{4}{EI} \begin{bmatrix} 0.933 & -0.466 \\ 0.466 & 1.732 \end{bmatrix} \begin{bmatrix} -16.04 \\ -2 \end{bmatrix}$$

$$[D] = \frac{4}{EI} \begin{bmatrix} -14.003 \\ 4.01 \end{bmatrix}$$

5

Step # 6 Compute Member End Actions

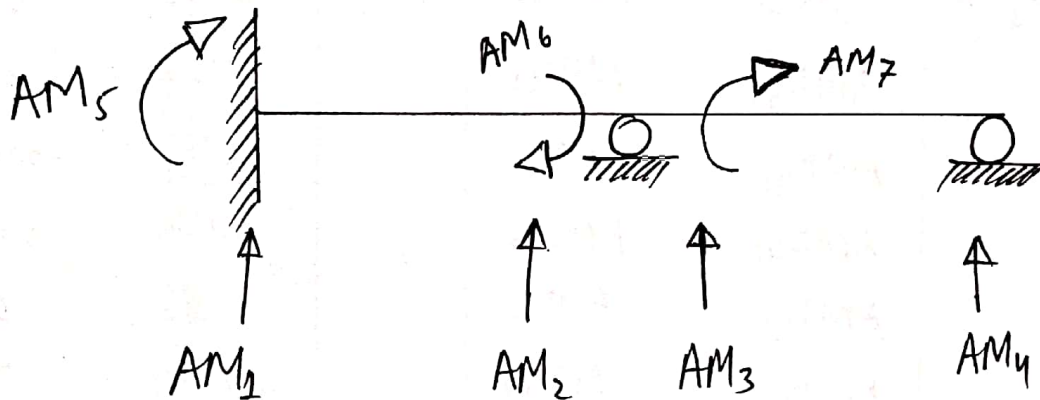

$$[AM] = [AML] + [AMD][D]$$

$$[AML] ; [AML] = \begin{bmatrix} AML_1 \\ AML_2 \\ AML_3 \\ AML_4 \\ AML_5 \\ AML_6 \\ AML_7 \end{bmatrix} = \begin{bmatrix} 18.19 \text{ K} \\ 11.81 \text{ K} \\ 6 \text{ K} \\ 6 \text{ K} \\ -29.39 \text{ K} \\ 22.04 \text{ K} \\ -6 \text{ K} \end{bmatrix}$$

⑥

[AMD] ;

$$[AMD] = \begin{bmatrix} AMD_{11} & AMD_{12} \\ AMD_{21} & AMD_{22} \\ AMD_{31} & AMD_{32} \\ AMD_{41} & AMD_{42} \\ AMD_{51} & AMD_{52} \\ AMD_{61} & AMD_{62} \\ AMD_{71} & AMD_{72} \end{bmatrix} = EI \begin{bmatrix} -0.122 & 0 \\ 0.122 & 0 \\ -0.167 & -0.167 \\ 0.167 & 0.167 \\ 0.286 & 0 \\ 0.571 & 0 \\ 0.667 & 0.333 \end{bmatrix}$$

Now $[AM] = [AML] + [AMD][D]$

$$[AM] = \begin{bmatrix} 18.19 \\ 11.81 \\ 6 \\ 6 \\ -29.39 \\ 22.04 \\ -6 \end{bmatrix} + \begin{bmatrix} -0.122 & 0 \\ 0.122 & 0 \\ -0.167 & -0.167 \\ 0.167 & 0.167 \\ 0.286 & 0 \\ 0.571 & 0 \\ 0.667 & 0.333 \end{bmatrix} \cancel{EI} \times \frac{1}{\cancel{EI}} \begin{bmatrix} -14.03 \\ 4.01 \end{bmatrix}$$

$$AM = \begin{bmatrix} 19.9K \\ 10.1K \\ 7.67K \\ 4.33K \\ -33.4'K \\ 14.03'K \\ -14.03'K \end{bmatrix}$$

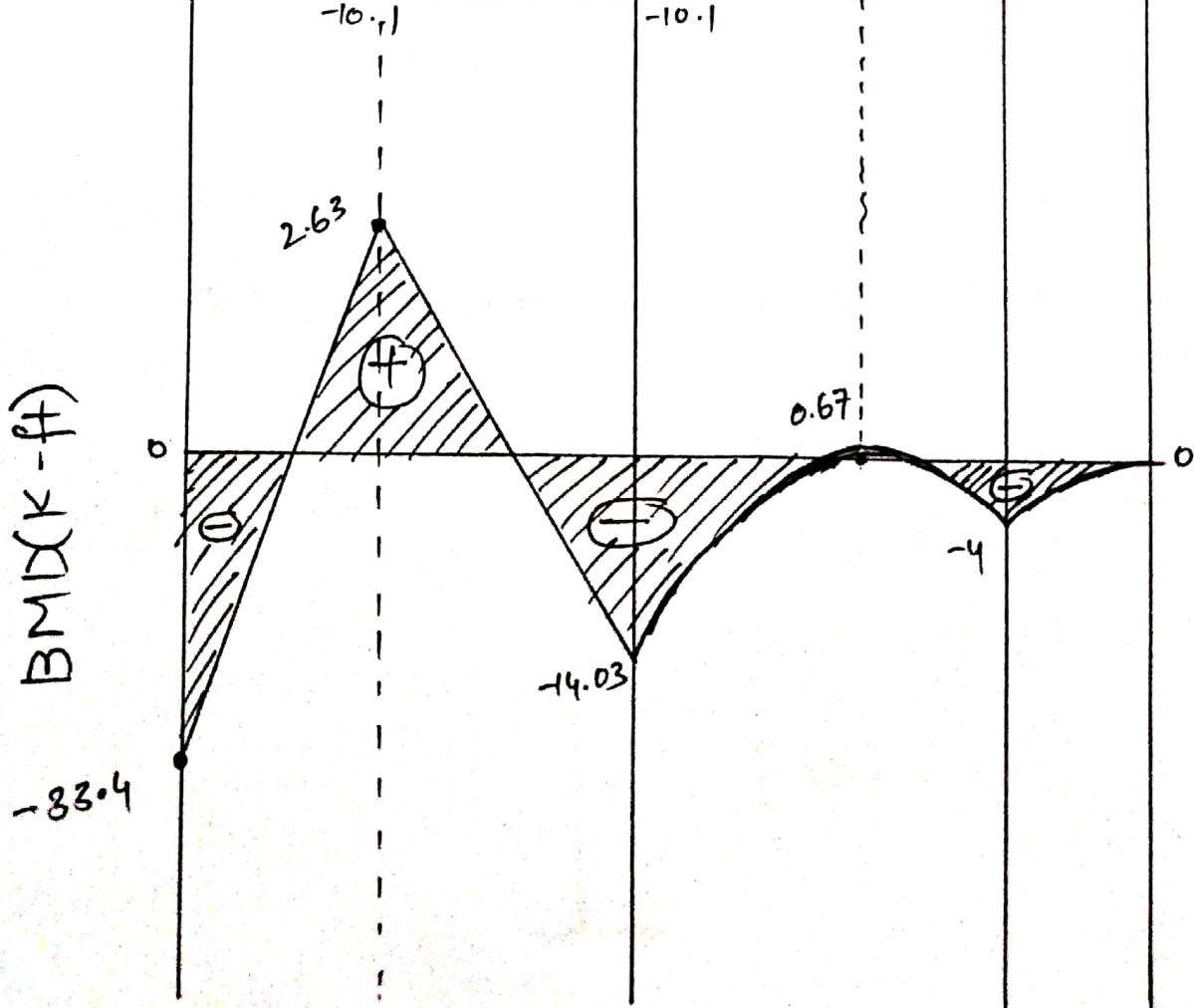
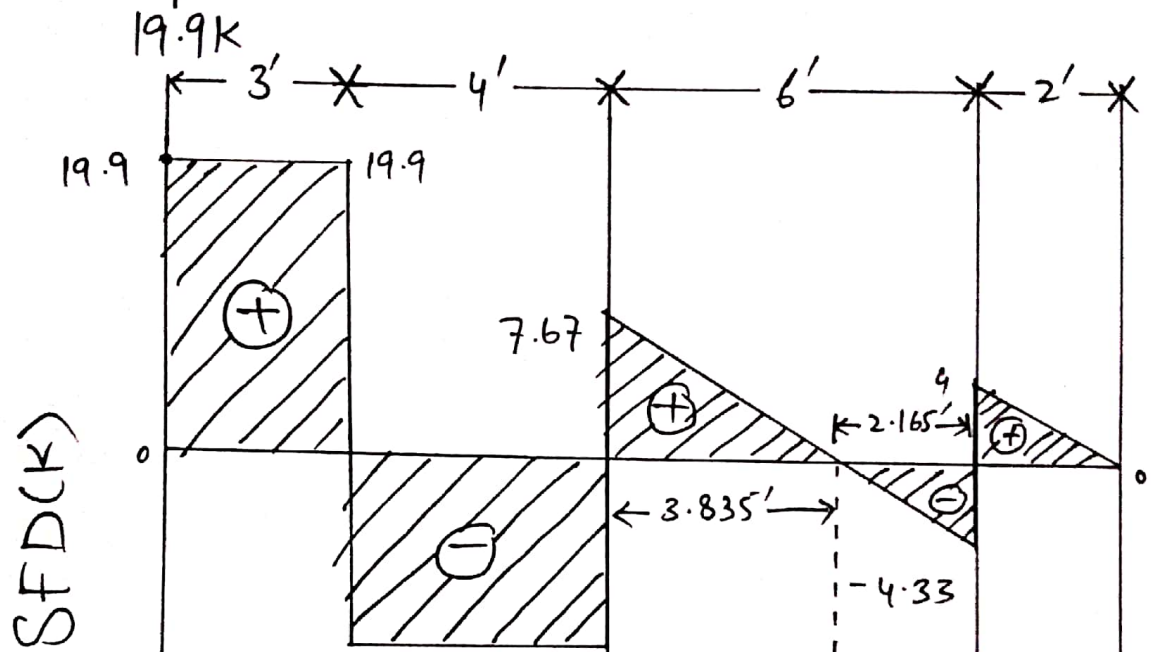
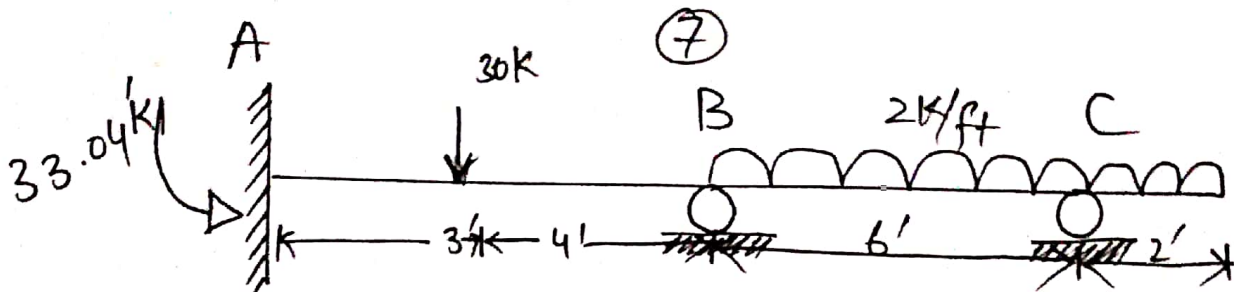

Complete Problem # 1

Q: 02

(8)

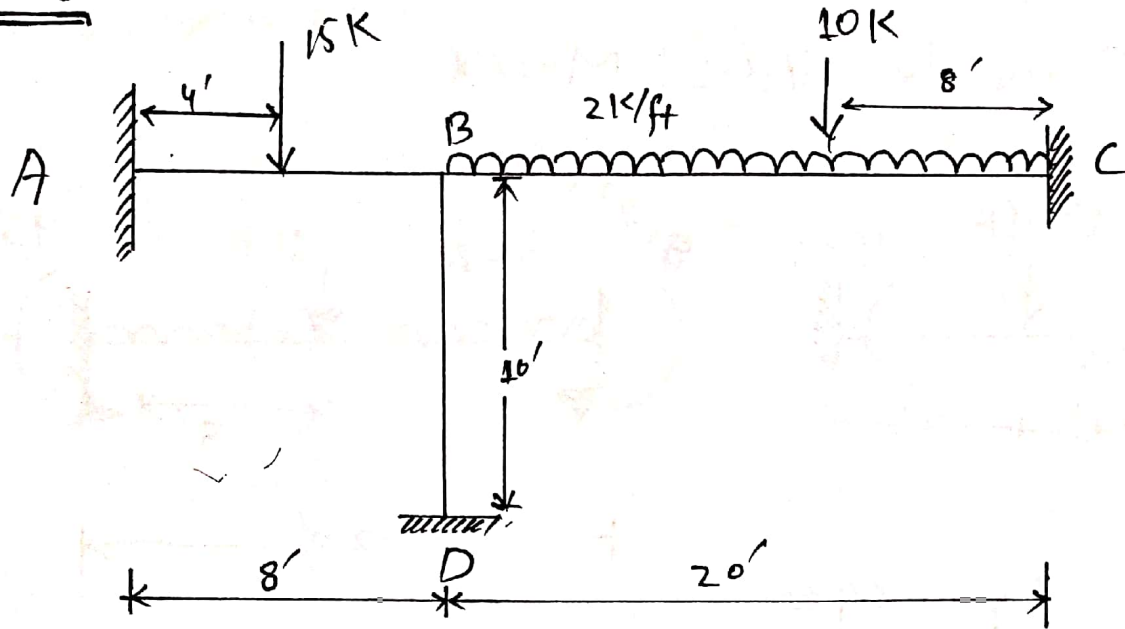

Solution:

Step # 1

Determine Kinematic Indeterminacy

$$K.I = 1^{\circ}$$

Step # 02

Determine Unknown Joint Displacement.

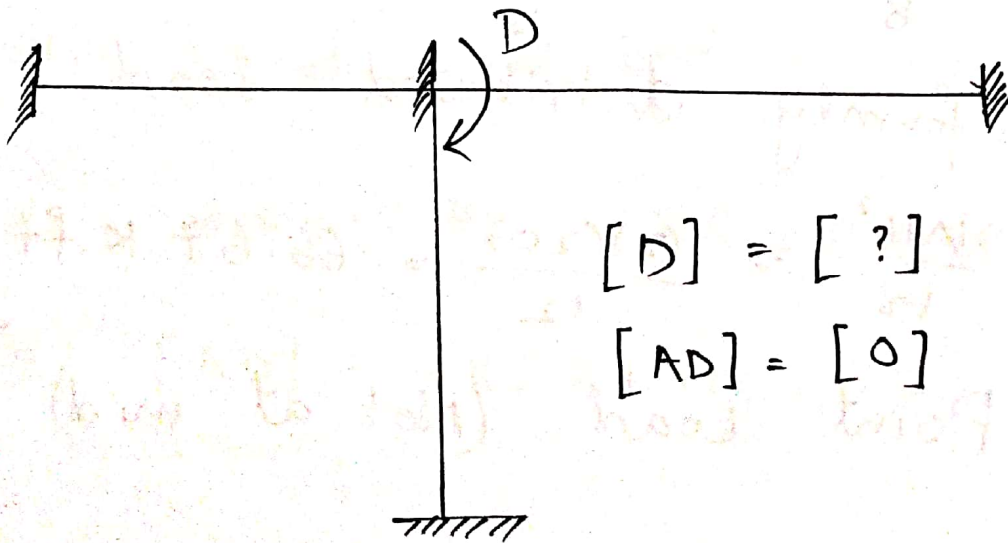

$$[D] = [?]$$

$$[AD] = [0]$$

Step # 03

(9)

Compute [ADL] Matrix

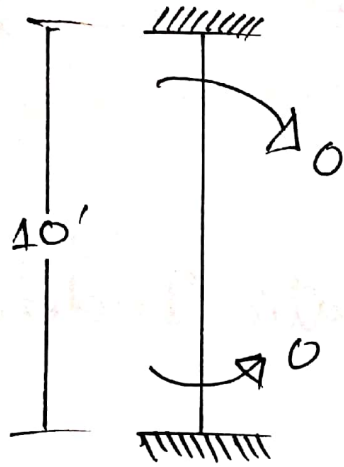
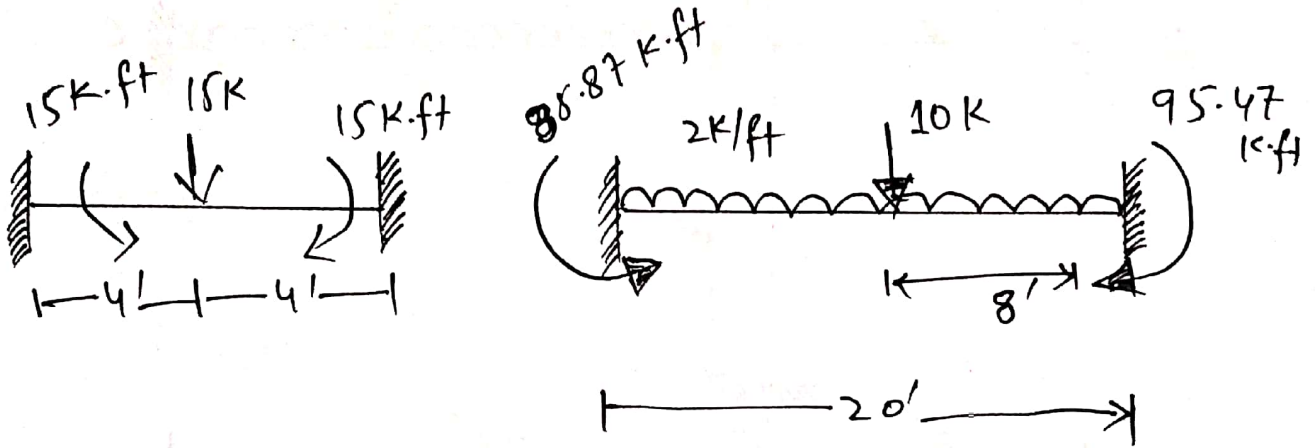

Point load at center :-

$$\frac{PL}{8} = \frac{(15)(8)}{8} = 15 \text{ Kip-ft}$$

Now formly distributed load

$$\frac{WL^2}{12} \Rightarrow \frac{(2)(20)^2}{12} = 66.67 \text{ K-ft}$$

⇒ Point Load (Not at mid)

Suppose

(10)

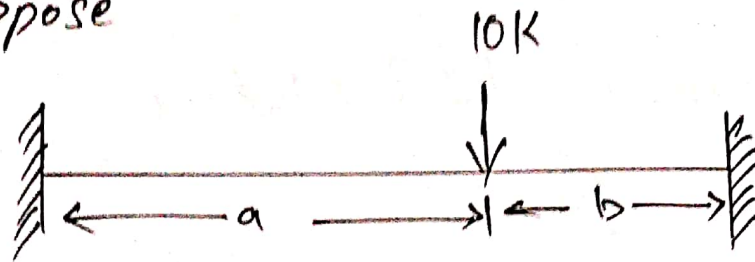

For Left End:-

$$\frac{Pab^2}{L^2} \Rightarrow \frac{10(12)(8)^2}{(20)^2} = 19.2 \text{ K}\cdot\text{ft}$$

For Right End:-

$$\frac{Pab^2}{L^2} \Rightarrow \frac{(10)(12)^2(8)}{(20)^2} = 28.8 \text{ K}\cdot\text{ft}$$

So that Moment at left end:-

$$19.2 + 66.67 = 85.87 \text{ K}\cdot\text{ft}$$

Similarly at right end:-

$$28.8 + 66.67 = 95.47 \text{ K}\cdot\text{ft}$$

$$\text{So } [AD] = -85.87 + 15 = -70.37 \text{ K}\cdot\text{ft}$$

Step # 04

(11)

Determine $[S]$ Matrix

$$[S] = [S_{11}]$$

Now

$$D = 1 K$$

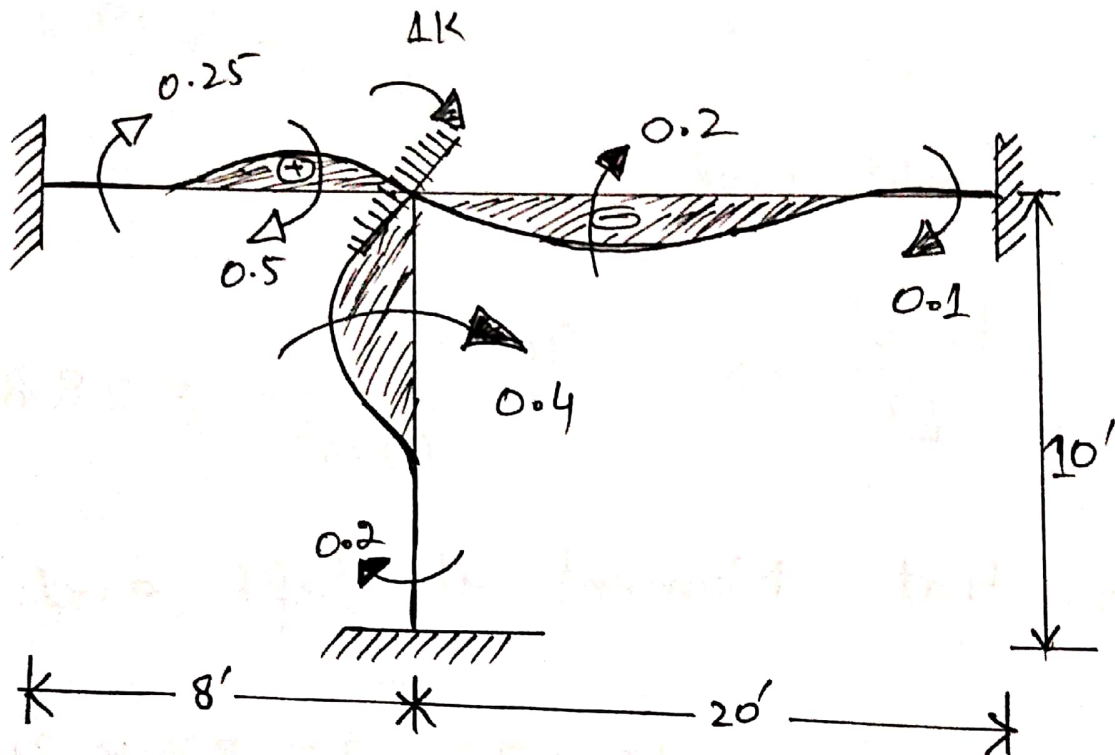

$$\Rightarrow \frac{4EI}{8} = 0.5$$

$$\frac{2EI}{8} = 0.25$$

$$\Rightarrow \frac{4EI}{20} = 0.2$$

$$\frac{2EI}{20} = 0.1$$

$$\Rightarrow \frac{4EI}{10} = 0.4$$

$$\frac{2EI}{10} = 0.2$$

$$[S] = (0.5 + 0.4 + 0.2) EI$$

$$= 1.1 EI$$

$$[S] = 1.1 EI$$

Step # 05

Compute [D] Matrix

$$[D] = [S]^{-1} \times [AD] - [ADL]$$

$$[D] = \frac{1}{1.1} \times [0] - [-70.87]$$

$$= \frac{70.87}{1.1}$$

$$[D] = [64.42] \times \frac{1}{EI}$$

$$[D] = \frac{64.42}{EI}$$

Problem #03

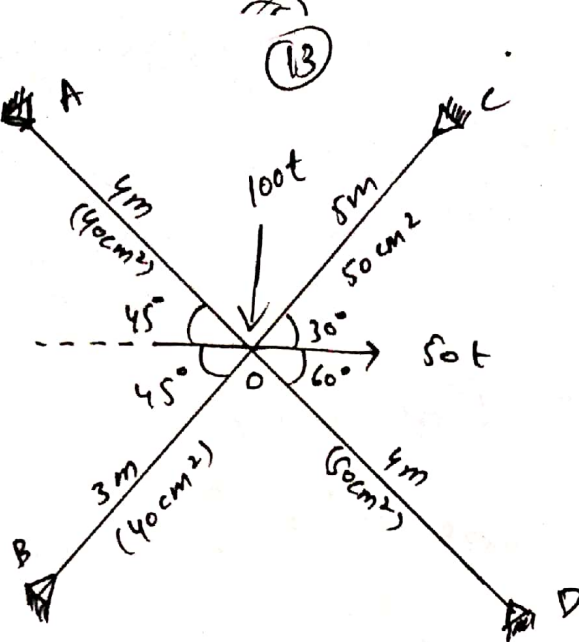

Solution:

For A :

$$\sin 45^\circ = \frac{P}{h} = \frac{P}{4}$$

$$\Rightarrow P = 2.828 \text{ m}$$

$$\cos 45^\circ = \frac{b}{4}$$

$$\Rightarrow b = 2.828 \text{ m}$$

For B :

$$\sin 45^\circ = \frac{P}{3}$$

$$\Rightarrow P = 2.12 \text{ m}$$

$$\cos 45^\circ = \frac{b}{h}$$

$$b = 2.12 \text{ m}$$

(14)

For C:-

$$\sin 30^\circ = \frac{P}{h=5}$$

$$\Rightarrow P \Rightarrow 2.5 \text{ m}$$

$$\cos 30^\circ = \frac{b}{5}$$

$$\Rightarrow b = 4.33 \text{ m}$$

Now

$$EA(A) = 2000 \times 40 = 80,000 \text{ t}$$

$$EA(B) = 2000 \times 40 = 80,000 \text{ t}$$

$$EA(C) = 2000 \times 50 = 100,000 \text{ t}$$

$$EA(D) = 2000 \times 58 = 150,500 \text{ t}$$

Step # 01 K.I

$$K.I = 2j - \gamma$$

$$= 2(5) - 8 = 2^\circ$$

Step # 02

Select Unknown joint + displacement

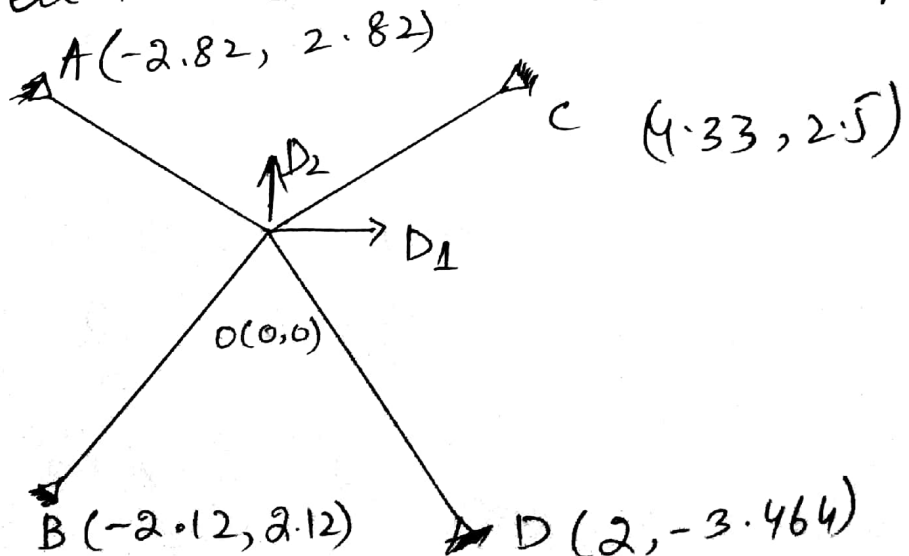

$$\begin{bmatrix} D_1 \\ D_2 \end{bmatrix} = \begin{bmatrix} ? \\ ? \end{bmatrix}, \quad \begin{bmatrix} AD_1 \\ AD_2 \end{bmatrix} = \begin{bmatrix} 50 \\ -100 \end{bmatrix}$$

Step # 03 $[AMD]_{4 \times 2}$ $E[S]_{2 \times 2}$

i) $D_1 = 1$, $D_2 = 0$

$$AMD = \frac{EA}{L^2} (X_R - X_j)$$

$$AMD_{11} = \frac{80,000}{(400)^2} \times (0 + 282) = 141$$

$$AMD_{21} = \frac{100,000}{(300)^2} \times (0 + 212) = 188.44$$

$$AMD_{31} = \frac{100,000}{(500)^2} \times (0 - 433) = -173.2$$

$$AMD_{41} = \frac{100,000}{(400)^2} \times (0 - 200) = -125$$

Now! $S_{11} = \sum_{j=1}^m \frac{EA}{L^3} (X_R - X_j)^2$

$$= \frac{80,000 \times (282)^2}{400^3} + \frac{80,000 \times (212)^2}{300^3} + \frac{100,000 \times (-433)^2}{500^3} +$$

$$+ \frac{100,000 \times (-200)^2}{(400)^3}$$

$$S_{11} = 99.405 + 133.107 + 149.991 + 82.5$$

$$S_{11} = 445.063$$

$$S_{12} = S_{21} = \sum_{i=1}^m \frac{EA}{L^3} \times (\chi_k - \chi_j) (\gamma_k - \gamma_j) \quad (16)$$

$$= \frac{80,000}{400^3} \times (282)(-282) + \frac{80,000}{300^3} \times (212)(212) \\ + \frac{100,000}{500^3} \times (-250)(0-250) + \frac{100,000}{400^3} \times (-200)(0+346)$$

$$S_{12} = S_{21} = 12.237$$

ii) $D_1 = 0$, $D_1 = 1K'$

$$AMD = \frac{EA}{L^2} (\gamma_k - \gamma_j)$$

$$AMD_{12} = \frac{80,000}{400^2} (-282) = -141$$

$$AMD_{22} = \frac{80,000}{300^2} (212) = 188.44$$

$$AMD_{32} = \frac{100,000}{500^2} (-250) = -100$$

$$AMD_{42} = \frac{100,000}{400^2} (346) = 216.25$$

Now, $S_{22} = \sum_{1 \times 1}^m \frac{EA}{L^3} (\gamma_k - \gamma_j)^2$

$$= \frac{80,000}{400^3} (-282)^2 + \frac{80,000}{300^3} (212)^2 + \frac{100,000}{500^3} (-250)^2 \\ + \frac{100,000}{400^3} \times (346)^2$$

$$S_{22} = 469.628$$

Step # 04

(17)

$$[D] = [S]^{-1} \times [AD]$$

$$\begin{bmatrix} D_1 \\ D_2 \end{bmatrix} = \begin{bmatrix} 445.003 & 12.237 \\ 12.237 & 469.628 \end{bmatrix}^{-1} \times \begin{bmatrix} 50 \\ -100 \end{bmatrix}$$

$$\begin{bmatrix} D_1 \\ D_2 \end{bmatrix} = \begin{bmatrix} 0.1183 \\ -0.216 \end{bmatrix}$$

Step # 05 [AM]

$$\begin{bmatrix} AM_1 \\ AM_2 \\ AM_3 \\ AM_4 \end{bmatrix} = \begin{bmatrix} 141 & -141 \\ 188.44 & 188.44 \\ -173.2 & -100 \\ -125 & 216.25 \end{bmatrix} \times \begin{bmatrix} 0.1183 \\ -0.216 \end{bmatrix}$$

$$= \begin{bmatrix} 141 \times 0.1183 + (-141) \times (-0.216) \\ 188.44 \times 0.1183 + 188.44 \times (-0.216) \\ -173.2 \times 0.1183 + (-100) \times (-0.216) \\ -125 \times 0.1183 + 216.25 \times (-0.216) \end{bmatrix}$$

(18)

$$\begin{bmatrix} AM_1 \\ AM_2 \\ AM_3 \\ AM_4 \end{bmatrix} = \begin{bmatrix} 16.68 & + & 30.46 \\ 22.29 & - & 40.70 \\ -20.49 & + & 21.6 \\ -14.79 & - & 46.71 \end{bmatrix}$$

$$\begin{bmatrix} AM_1 \\ AM_2 \\ AM_3 \\ AM_4 \end{bmatrix} = \begin{bmatrix} 47.136 t \\ -18.413 t \\ 1.11 t \\ -61.498 t \end{bmatrix}$$

