

DEPARTMENT OF ELECTRICAL ENGINEERING



Engineering Drawing

Lab Manual

Spring - 2020

Instructor: Engr. Zulqarnain Abbasi

IQRA National University, Peshawar



Student Name:

M. Zeeshan

Semester:

2ND

Registration Number:

16529

Subject:

Engineering drawing



Engineering Drawing Lab

S.NO	LABS
01	Introduction to AutoCAD Environment
02	Command Line, Circle, Erase, Print and Ortho Commands
03	Modify toolbar, extend, offset, trimming objects, move, copy, stretch, mirror of objects and some other modify commands.
04	Object Snap properties and introduction to layers.
05	Designing using layers. Writing text, dimensioning objects.
06	Modify toolbar, extend, offset, trimming objects, move, copy, stretch, mirror of objects and some other modify commands.
07	Introduction to Blocks, Making blocks, Insertion of blocks
08	Hatching and Gradients
09	Overview of 3-D coordinate system. Rotation in 3-D
10	Working in 3-D Wireframe Model
11	Command Line, Circle, Erase, Print and Ortho Commands
12	
13	

Instructor: Engr. Zulaarnain Abbasi

Electrical Engineering Department, INU

Page 3

Lab-01

Introduction to AutoCAD Environment

Everything that you draw in AutoCAD is **exact**. It will be more accurate than you will ever need it to be. We're talking 14 decimal points accurate. All objects drawn on the screen are placed there based on a simple X, Y co-ordinate system. In AutoCAD this is known as the World Co-ordinate System (WCS). You must understand this to know how to put things where you want them. (*3-D work has an added axis, the Z-axis, but this is not covered in this lesson.*) Below is a diagram showing you how this system works (place your mouse on the diagram for more info).

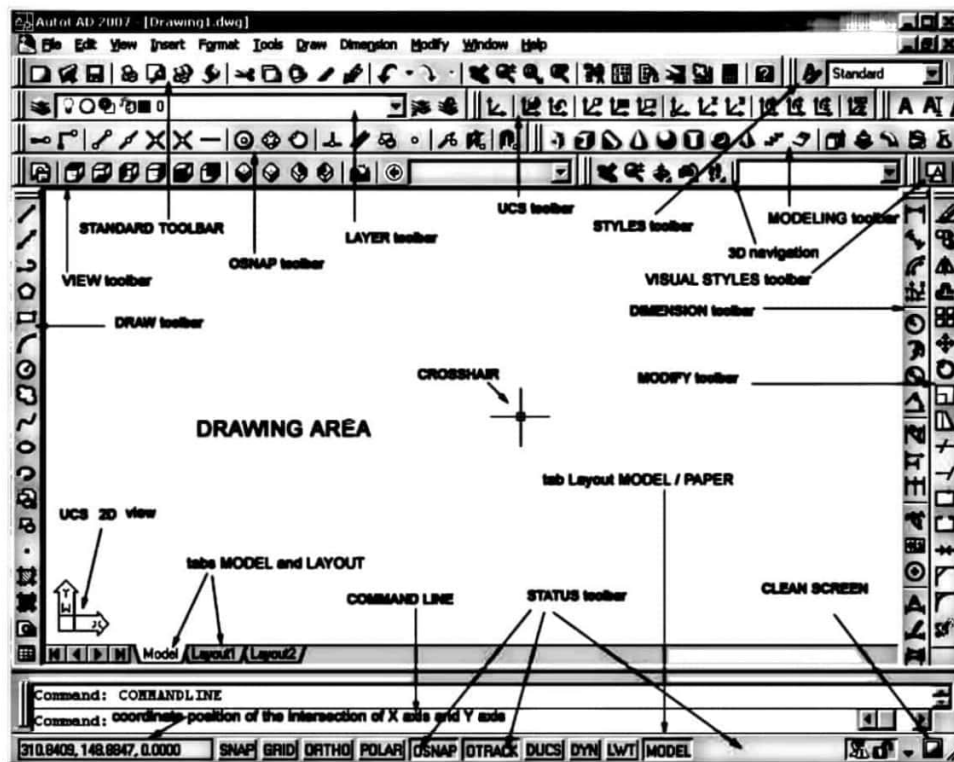

AutoCAD 2007 Interface

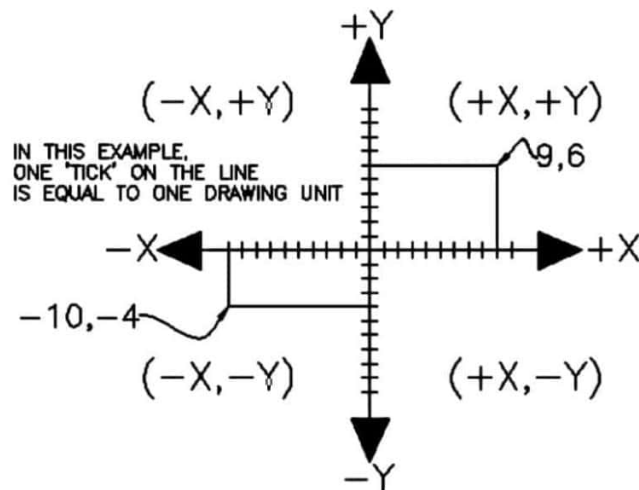

In order to work effectively with AutoCAD, you **have** to work with this system. Until you are comfortable and familiar with it, learning AutoCAD will be more of a chore. My experience in teaching is that the better a student is with co-ordinates, the better CAD draftsman they will become.

Here is how it works:

AutoCAD uses points to determine where an object is located. There is an origin where it begins counting from. This point is (0,0). Every object is located in relation to the origin. If you were to draw a line straight out to the right from the origin, this would be considered the positive X-axis. If you were to draw a line straight up, this would be the positive Y-axis. The picture above shows a point located at (9,6). This means that the point is 9 units over in the X-axis and 6 units up in the Y-axis. When you are working with points, X **always** comes first. The other point shown is (-10,-4). This means that the point is 10 units in the negative X-axis (left) and 4 units in the negative Y-axis (down).

A line has two points, a start point and an end point. AutoCAD works with the points to display the line on the screen. Move your cursor over the picture above and you will see line drawn from the absolute points of (-10,-4) to (9,6).

Most of the time you will not have an indication of where the origin is. You may need to draw a line from the endpoint of an existing line. To do this you use relative points. These work the same way, but you have to add the @ symbol (shift+2) to tell AutoCAD that this next point is relative from the last point entered.

To review:

- ABSOLUTE POINTS** are exact points on the drawing drawing space.
- RELATIVE POINTS** are relative to an OBJECT on the drawing space.

It's a simple system, but mastering it is the key to working with AutoCAD and is explained in more detail further below.

Angular Measurement

AutoCAD measures angles in a particular way also. Look at the diagram below and then place your mouse on it to see how this is done.

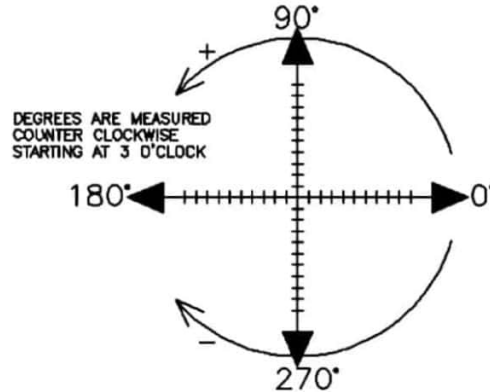

When drawing lines at an angle, you have to begin measuring the angle from 0 degrees, which is at the 3 o'clock position. If you drew a line at 90 degrees, it would go straight up. The example above (when you move your mouse over it) shows a line drawn at +300 degrees ($270+30$), or -60 degrees.

You might not always have an obvious reference point for 0 degrees. Look at the example below and place your mouse on the image to find out the angle in question.

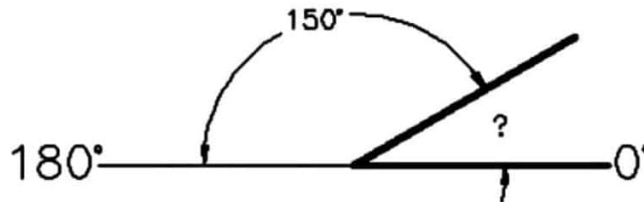

In this example, you are given information about the lines, but not the angle AutoCAD needs to draw the line from the start point. What you are given though, is (a) the knowledge that 0° is at the 3 o'clock position (b) the knowledge that 180° is at the 9 o'clock position and (c) the angle between 180° and the line you want to draw is 150°.

With this information, you can figure out what angle you need. Here is a fool-proof way of getting the angle you need:

- 1.) Start at the 0° position and measure counter-clockwise (+) to 180°.
- 2.) From 180°, measure clockwise 150° (-)
- 3.) Consider that you just went +180-150 and use that as an equation: +180-150=30
- 4.) Now you can draw your line using polar co-ordinates (discussed below)

Entering Points in AutoCAD

You can enter points directly on the command line using three different systems. The one you use will depend on which is more applicable for the situation. The first assignment will get you used to this. The three systems are as follows:

ABSOLUTE CO-ORDINATES - Using this method, you enter the points as they relate to the origin of the WCS. To enter a point just enter in the exact point as **X,Y**.

RELATIVE CO-ORDINATES - This allows you to enter points in relation to the first point you have entered. After you've entered one point, the next would be entered as **@X,Y**. This means that AutoCAD will draw a line from the first point to another point X units over and Y units up relative to the previous point.

POLAR CO-ORDINATES - You would use this system if you know that you want to draw a line a certain distance at a particular angle. You would enter this as **@D<A**. In this case, **D** is the distance and **A** is the angle. Example: **@10<90** will draw a line 10 units straight up from the first point.

The three ways of entering co-ordinates shown above are the **ONLY** way AutoCAD accepts input. First decide which style you need to use, and then enter as shown. Remember that **X** is always before **Y** (alphabetical). Don't forget the '@' symbol when you are entering relative points. Any typing error or omission will give you results you don't want. If you make a mistake and need to see what you typed, press **F2** to bring up the text screen and check your typing. (press **F2** to get back to your drawing.)

Move your cursor around the image above to find the names of various areas of the screen.

Lab Task.

- a) Draw a line from the origin to the point (10,-12) of the XY plane by Absolute co-ordinates method

- b) Next draw another line from the endpoint of the first line to $(-10,12)$ point using Relative Co-ordinates method
- c) Next draw a third line from the end point of the second line with a magnitude of 10 and having angle of 45° using polar co-ordinate method.

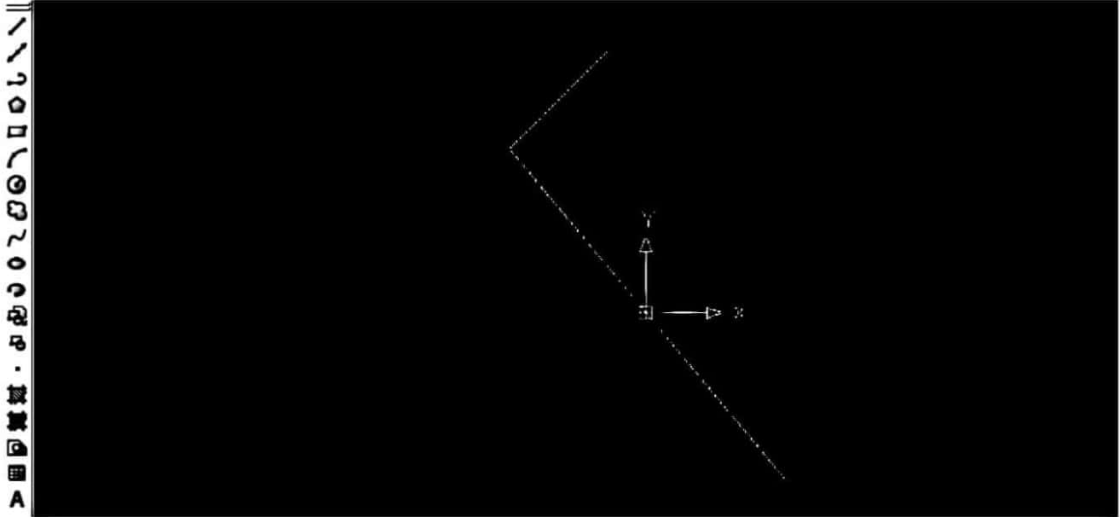





Lab-02

Command Line, Circle, Erase, Print and Ortho Commands

AutoCAD allows you to have access to a large number of commands. A general rule is that you will use 20% of the commands 80% of the time. The important thing to remember is that AutoCAD will expect you give it information in a very particular order. The most frustrating thing when you begin using this program is that you will try to do something, but AutoCAD will 'not work'. In most cases, it means that you are trying to input information at the wrong time. This is why it is **very important** to be in the habit of looking at the command line.

The command line tells you what information AutoCAD requires to continue.

Your first drawing assignment will be to use the drawing commands in conjunction with the co-ordinate system defined in **Lab-1**. This is a basic assignment, but it is very important to understand how to give the program accurate information. You will use the following commands:

Command	Keystroke	Icon	Location	Result
Line	Line / L		Home > Line	Draw a straight line segment from one point to the next
Circle	Circle / C		Home > Circle > Center, Radius	Draws a circle based on a center point and radius.
Erase	Erase / E		Modify > Erase	Erases an object.
Print	Print / Plot CTRL+P		Quick Access Toolbar > Print	Enables the Print/Plot Configuration Dialog Box
Undo	U / CTRL+Z		Quick Access Toolbar > Undo	Undoes the last command.

Consider a set of drawings:

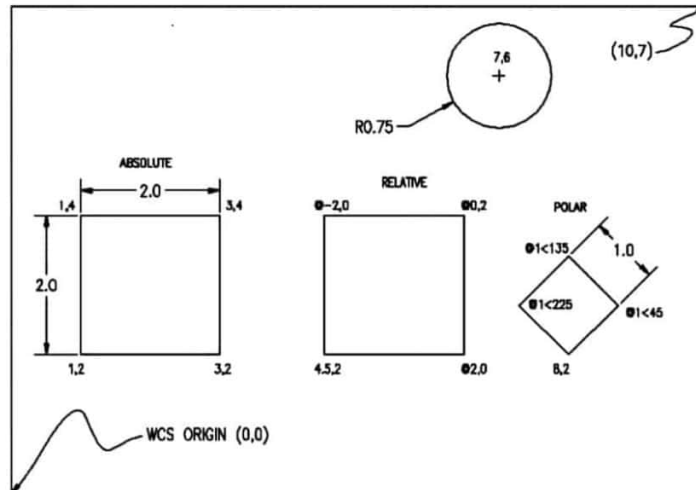

Select the "acad.dwt" template file and press the **Open** button to continue to the drawing screen.

Once there, type in **Z** <ENTER> **E** <ENTER> this will zoom into to the extents of the drawing area and make it easier to see what you are drawing (NOTE: nothing will appear to happen).

Start the **LINE** command (as explained in the table above) and draw a line from **1, 2** to **3, 2** to **3, 4** to **1, 4** Press enter after each point. (***Remember to watch the command line as you do this.**) For the last line, you can either type in **1, 2** or **C** to close the line back to the first point you entered. You have just drawn a 2" square using absolute co-ordinates. Your command history (F2 key) should look like this:

Command: L LINE Specify first point: 1, 2

Specify next point or [Undo]: 3, 2

Specify next point or [Undo]: 3, 4

Specify next point or [Close/Undo]: 1, 4

Specify next point or [Close/Undo]: 1, 2

Specify next point or [Close/Undo] : <ENTER>

If you make a mistake, you can use the **undo** icon, press **U** or press **CTRL+Z**.

You can also use the **ERASE** command to get rid of lines you don't want.

Next draw a similar box using **relative co-ordinates**. Start the **LINE** command and begin at point **4.5,2**. From there draw a line two units to the right by typing **@2,0** (this means 2 units in the X direction, 0 units in the Y direction based on the last point you entered). Next type **@0,2** then **@-2,0** then **@0,-2** to finish the box. (Remember to press enter after each point.)

Now erase the last box you just drew. Start the **ERASE** command and then select the lines you want to erase. Then press <enter>. Now redraw the box for more practice!

Draw a third box using **polar co-ordinate** input. Start the **LINE** command and begin at point **8,2** then enter. Type **@1<45** to draw the first line. Next enter **@1<135** then **@1<225** then **@1<315** (or **C** to close). What you have just done is drawn a line 1 unit long at 45°, then another at 135° and so on. Do the angles you entered make sense to you? If not, review it.

Start the **CIRCLE** command and add a circle that has a center point at **7, 6** with a radius of **.75** (Watch the command line for instructions).

To finish the drawing, try putting a 10"x7" border around the page starting at **0, 0** using the any of the methods shown above (relative, absolute or polar).

Lab Task: Draw the following figure. Also print the command line:

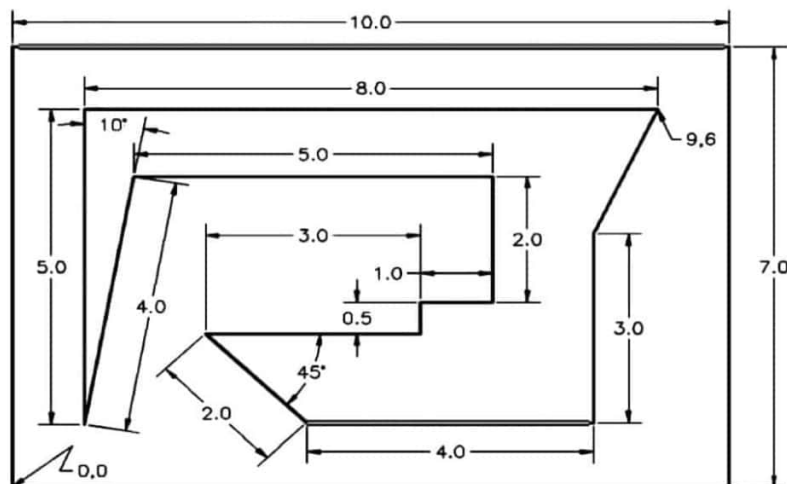

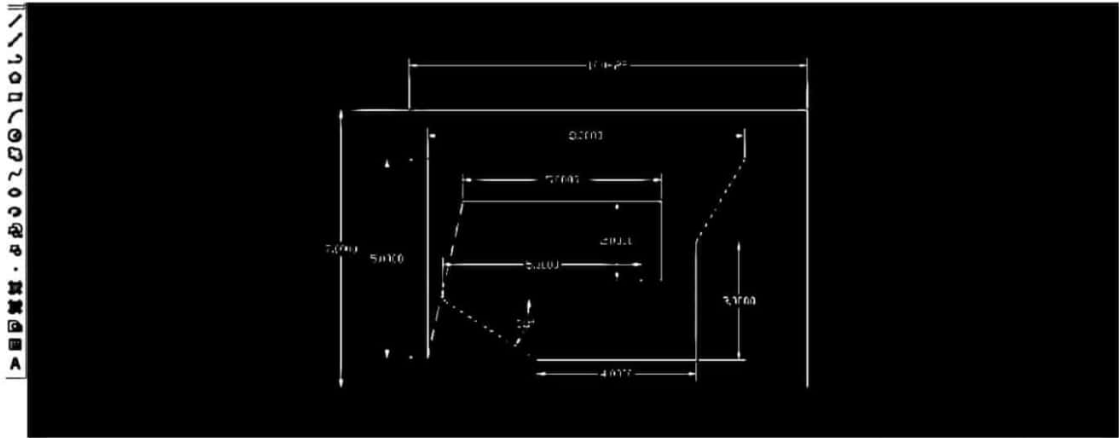

Command:

For line (L) specify point (0,10)

Specify next point (@0,7)

Specify next point (@-10,0)

Specify next point (@0,-10)

For line (L) specify points (0,4)

Specify next point (@0,3)

Specify next angle (@,<75)

Specify next point (@-8,0)

Specify next point (@0,-5)

Specify angle @,<10)

Specify next point (@0,4)

Specify next point (@0,5)

Specify next point (@0,-2)

Specify next point (@-1,0)





Specify next point (@0,-0.5)

Specify next point (@-4,0)

Lab 03:

Modify toolbar, extend, offset, trimming objects, move, copy, stretch, mirror of objects and some other modify commands.

In AutoCAD, you may actually use modifying commands more often than drawing commands. Now that you know the basics, here's some more commands to add to your collection. Three commands, Trim, Extend and Offset are used standard AutoCAD work.

Command	Keystroke	Icon	Location	Result
Rectangle	RECTANGLE / REC		Home > Draw > <u>R</u> ectangle	Draws a rectangle after you enter one corner and then the second.
Trim	TRIM / TR		Home > <u>M</u> odify > <u>T</u> rim	Trims objects to a selected cutting edge.
Extend	EXTEND / EX		Home > <u>M</u> odify > <u>E</u> xtend	Extends objects to a selected boundary edge.
Offset	OFFSET / O		Home > <u>M</u> odify > <u>O</u> ffset	Offsets an object (parallel) by a set distance.

Consider the following figures:

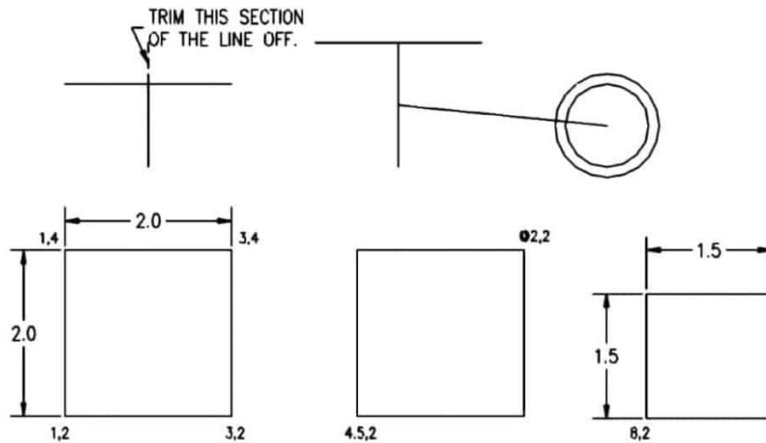

Draw a **LINE** from 1,2 to 3,2 to 3,4 to 1,4 (***Remember to watch the command line as you do this.**) For the last line's endpoint, you can either type in 1,2 or **C** to close the line back to the first point you entered. These are absolute co-ordinates. Make sure you understand what the points you just entered represent.

Draw the next square using the **RECTANGLE** command. A rectangle is created by specifying 2 points to represent the opposite corners. Enter the first point as **4,5,2** and then make the opposite corner 2 inches over and 2 inches up **@2,2** using **relative coordinates**. This is much faster and also makes the square **one object** and not 4 separate lines.

ERASE the rectangle. You will see that all of it is gone with **one pick**. Redraw it and continue.

For the 3rd square, draw a 1.5 x 1.5 unit square using any of the methods you know. The bottom left corner must be a **8,2**.

Draw a line from **2,5** to **2,6.5** Draw another line from **1,6** to **3,6** You should now have two perpendicular lines. What you want to do is trim off the top of the vertical line and create a T.

Start the **TRIM** command. It will first ask for a cutting edge. Select the horizontal line and press **<ENTER>**. It will now ask for the object to be trimmed. Select the vertical line anywhere above the horizontal (cutting) line and press **<ENTER>** to finish the command.

This is what you saw on the command line:

```
Command: TR <enter> TRIM
Current settings: Projection=UCS, Edge=None
Select cutting edges ...
Select objects: <Select the Horizontal line> 1 found
Select objects: <enter>
Select object to trim or shift-select to extend or
[Fence/Crossing/Project/Edge/eRase/Undo]: <Select the vertical line>
Select object to trim or shift-select to extend or [Project/Edge/Undo]: <enter>
```

Once again, it is important to keep your eye on the command line as it will guide you through most commands.

Draw a **LINE** from **4,6.5** to **6,6.5** Draw another line from **5,5** to **5,6** What you want to do now is **extend** the vertical line up to the meet horizontal line. Start the **EXTEND** command. AutoCAD asks for a boundary edge; select the horizontal line press **<ENTER>**. It then asks for an object to extend; select somewhere in the **top half** of the vertical line. Press **<ENTER>** to end the command. Your command line history should match what is shown below.

```
Command: EX <enter> EXTEND
Current settings: Projection=UCS, Edge=None
Select boundary edges ...
Select objects: <Select the horizontal line> 1 found
```





Select objects: <enter>

Select object to extend or shift-select to trim or [Fence/Crossing/Project/Edge/Undo]:

<Select the top half of the vertical line>

Select object to extend or shift-select to trim or [Project/Edge/Undo]: <enter>

Draw a **CIRCLE** with a center point of **7.5,5.5** with a radius of **.5** Now you will use to offset command to make another circle 1/4" larger. Start the **OFFSET** command (watch the command line) and enter **.125** as the offset distance (1/2 of 1/4"). Now select the circle and pick anywhere **outside** the circle. Press <ENTER> to end the command

Command	Keystroke	Icon	Location	Result
Move	Move / M		Home > Modify > Move	Moves an object or objects
Copy	Copy / CP		Home > Modify > Copy	Copies object(s) once or multiple times
Stretch	Stretch / S		Home > Modify > Stretch	Stretches an object after you have selected a portion of it
Mirror	Mirror / MI		Home > Modify > Mirror	Creates a mirror image of an object or selection set

Consider the figures:

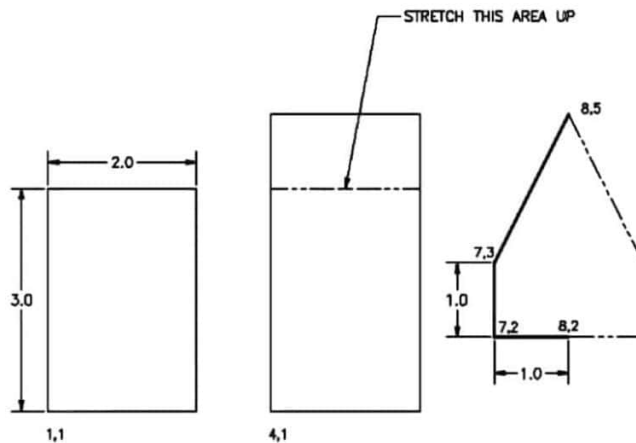

Draw a 2" wide by 3" high rectangle using the **RECTANGLE** command. The bottom left corner must be at **0,0**

Notice that the small rectangle and the border are overlapping each other at the bottom left of your drawing. What you want to do is move the small rectangle over 1" and up 1" so that it is away from the border.

To do this, start the **MOVE** command by typing in either **M** or **MOVE <ENTER>**. Select all the lines of the rectangle using one of the selection methods described earlier. Press **<ENTER>**. Now AutoCAD asks for a "base point or displacement". What it is needing is a reference point. Click on the bottom left corner of the rectangle. AutoCAD now asks for a 'second point of displacement'. What it needs to know now is how far you want to move it. This is a great time to use relative co-ordinates. In this case, you want to move it 1" over and 1" up. So type **@1,1 <ENTER>** to achieve this. The rectangle will automatically move to its new location.

Now you want to copy this rectangle 3" over to the right. The copy command is very similar to the move command. (The only difference is that the copy command leaves an original behind.)

Start the **COPY** command. And copy it **@3,0 <ENTER>** The rectangle has now been copied 3" over.

But the rectangle is not as tall as the one in the sample drawing, the sample drawing's rectangle is 1" taller. To modify this, you'll use the stretch command.

Start the **STRETCH** command by typing **S <ENTER>**. AutoCAD now makes you select objects by using a crossing window or crossing polygon. You're going to use a crossing window. Remember from the Lesson 1-5 that you make a **crossing window** by creating it from the right to left. Left-click just a bit above and to the right of the top right hand corner of the new rectangle (P1). Move your crosshairs down and to the left until your

(dotted) crossing window covers the top half of the rectangle completely and then left click again (P2). You'll see that the objects are highlighted now. Press <ENTER> to accept this. Next you're asked for that now familiar base point. Pick on the top left corner of the rectangle. Now give AutoCAD the second point of displacement. In this case, you want to stretch the rectangle 1" up, so type @0,1 <ENTER> to do this. The rectangle is now 1" taller.

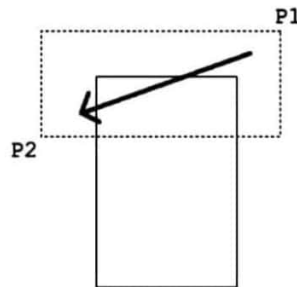

The goal when selecting objects to stretch is to draw the window over the vertices or points that you want to stretch. If you miss a corner, you will change the shape of the rectangle. So always be aware of which points need to be stretched. In this example, it was pretty obvious, in more complex drawings - it won't be.

Next you want to draw the polygon on the right side. To do this, you will draw the three lines on the left side first and then mirror those lines over to the right side. Draw the 3 lines any way you like (hint: use absolute co-ordinates)

Once they are drawn, begin the **MIRROR** command. Select the three lines (press <ENTER>) Now you are asked for the first point of the mirror line. With your endpoint Osnap turned on, pick the end of the line at 8,2. Now you are asked for the second point. Select the point on the line at 8,5. Once you've done this, AutoCAD wants to know if you want to delete the old objects. In this case you don't, so accept the default by pressing <ENTER>. The mirror line will be half-way between the object the you are mirroring and where you want it to be. Figuring out where the mirror line is the toughest part of this command.

Lab Task: Complete the above exercise on your own, also print the command prompt.









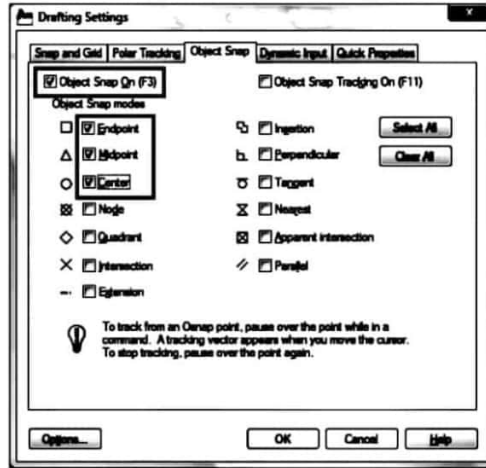



Lab 04:

Object Snap properties and introduction to layers.

Object Snaps

Suppose you want to draw a line from the center of the circle to the middle of the vertical line you extended earlier. AutoCAD has a feature that makes this very easy. These are the Object Snaps (or Osnaps "Oh-Snaps"). Type **OS <ENTER>**. You will see this dialog box appear.



ICON	SETTING	ICON	SETTING
	Endpoint		Insertion Point
	Midpoint		Perpendicular
	Center		Tangent
	Node		Nearest
	Quadrant		Apparent Intersection
	Intersection		Parallel

---	Extension	<u>M2P</u>	Midpoint between 2 points
-----	-----------	------------	------------------------------

You may select whichever points you want to 'snap' on an object. Here is a list of your options. Followed by the command entry to invoke the needed Osnap.

Endpoint - snaps to either the beginning or the end of an object such as a line - **END**

Midpoint - snaps to the exact middle of a line or an arc - **MID**

Center - snaps to the center-point of a circle or arc - **CEN**

Node - snaps to 'nodes' (not covered in this course) - **NOD**

Quadrant - snaps to any of the four quadrants of a circle - **QUA**

Intersection - snaps to the point where two object cross - **INT**

Extension - Snaps to the phantom extension of an arc or line - **EXT**

Insertion - snaps to the insertion point of an object (such as a block or text) - **INS**

Perpendicular - will snap so that the result is perpendicular to line selected - **PER**

Tangent - snaps to create a line tangent to a circle or arc - **TAN**

Nearest - will find the closest point an object and snap to that point - **NEA**

Parallel -Snaps parallel to a specified line - **PAR**

Layers:

Layers are used to organize drawings. Imagine a large project for a high-rise tower. The designers would create layers for the electrical, plumbing, landscape and more. It is necessary to control the drawing and turn some layers off and view only the ones you want. This is one reason why layers are needed. When you go on to use AutoCAD professionally, every drawing you deal with will have layers.

You will be creating a layer for the dimensions, one for the objects (lines that were drawn) and another for the text. Start the **LAYER** command (**LA**). This will bring up the Layer Properties Manager Palette (shown below). We'll cover the things that are used in this lesson.

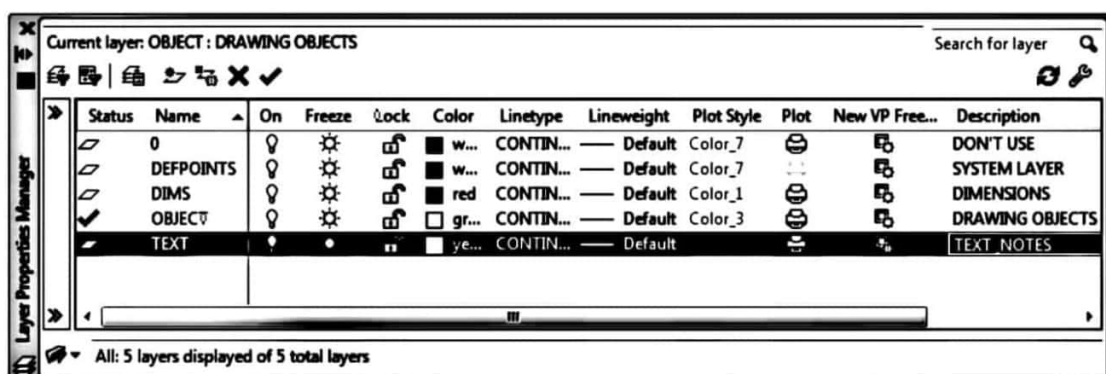

Looking at the Dialog Box, you will see a lot of information.

From left to right, this is what the columns are for (not everything is used in this level).

Status	This column has a green check to indicate the current layer (all new objects will be drawn on that layer). Double click here to make the layer current.
Name	Give the layer a good, descriptive name (but not too long)
On	Turns the visibility of that layer on (visible) or off (invisible)
Freeze	Similar to 'On', but can be used in Viewports (later tutorial)
Lock	Retain visibility, but disable modifying objects on the locked layer.
Color	Used to select the color for objects drawn on each layer
Linetype	Used to select the linetype for objects drawn on each layer
Lineweight	Used to select the lineweight for objects drawn on each layer
Plot Style	Plot styles are used to define how objects are plotted - this can be different from the properties described above.
Plot	Set the layer to either plot (on) or not (off)
New VP Freeze	When on, it will freeze the selected layer in new viewports when they (viewports) are created
Description	Use this to give a description to your layer system - very important when working with other users.

Now you have the dialog box on your screen, click the 'New' button. This will create a new layer and give you an opportunity to name it. Name this layer **TEXT**. Click on the small box towards the right and select **yellow** for the color. Create another layer and call this one **DIMS** (for dimensions), and make its color **red**. Finally, create a third layer and call it **OBJECT** and make its color **green**. You have just created three new layers in your drawing. Highlight the TEXT layer and then press the 'Make Current' button. This makes the TEXT layer current and anything you draw will be placed on that layer. Your Dialog box should look like the one above. If it does, press **OK** to close the dialog box.

Lab Task: Draw the following figure in AutoCAD. Also, print the commands. Use Object snap properties for your ease.

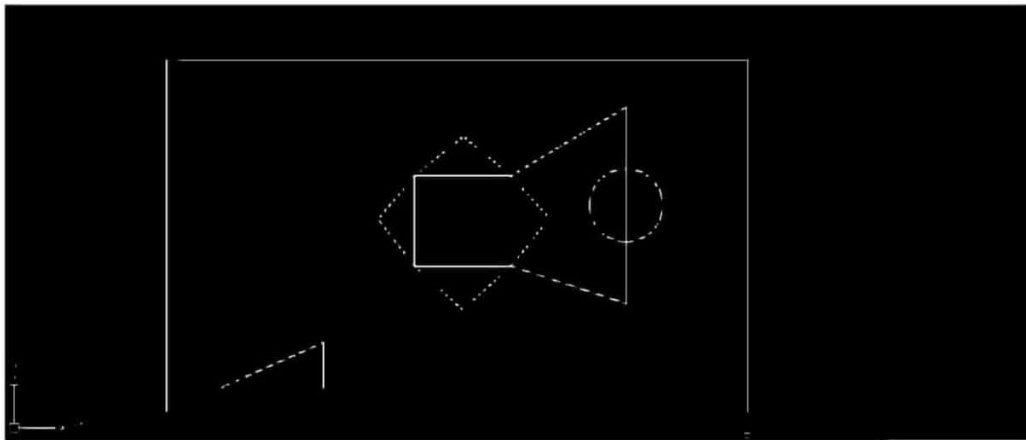
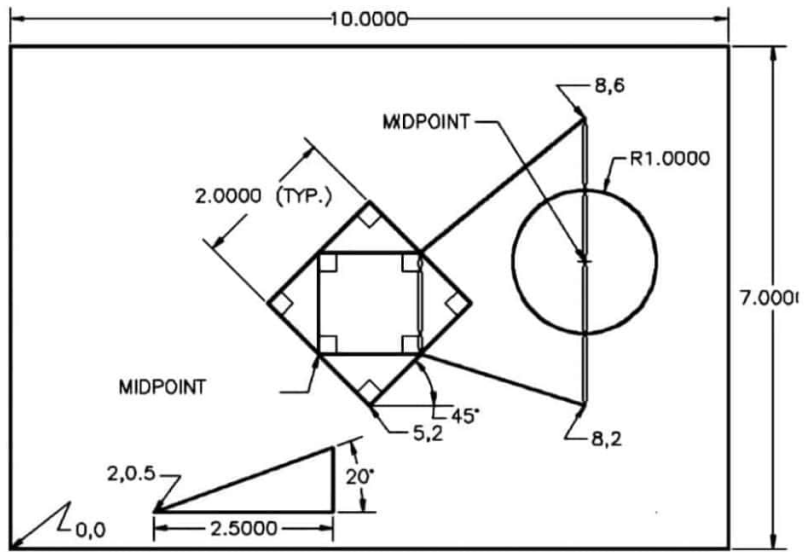

Lab 05:

Designing using layers. Writing text, dimensioning objects.

Consider the following drawing:

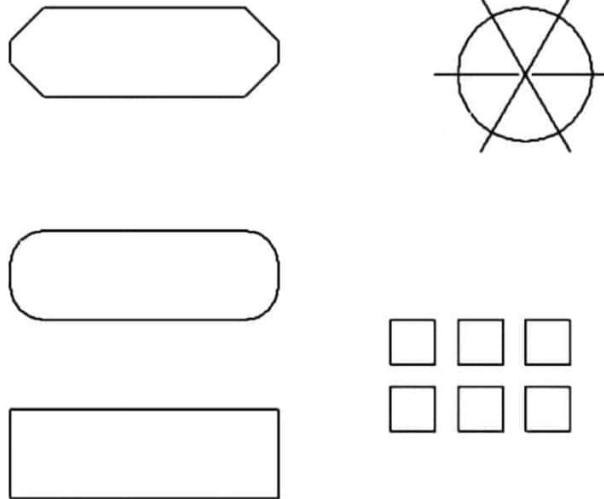

MY NAME – ASSIGNMENT #

Now that you have your layers, select all your objects and then look for the layer tool panel. There is a droplist there with all of your layer names. With your objects selected, change the layer to OBJECT. If all went well, your lines and circles will now be green and on the object layer.

ADDING TEXT

TEXT is your current drawing layer now, so what you will be doing is creating some text now. Type in **TEXT** on the command line. Look at the command line.

Command: TEXT
Justify/Style/<Start point>:

The first thing AutoCAD wants is a starting point for the text. Type: **0,0** to place it at the bottom left corner of your drawing. Notice that there are other options you could make, but ignore them for now.

Height <0.2000>: <ENTER>

Next, AutoCAD wants to know how tall you want your letters to be. For this assignment, you want them to be 1/4" tall. Type in **.25** at the Height prompt.

Rotation angle <0>: <ENTER>

One more thing before you start typing in text, tell AutoCAD if you want to have your text rotated. Not this time, so press **<ENTER>** to accept the default of 0 degrees.

Text: (YOUR NAME - ASSIGNMENT #5)

Finally you can type in what you want to put on the drawing. At the prompt, type your **NAME** and **ASSIGNMENT #5** then press **<ENTER>**.

You will see that AutoCAD has placed your name in the bottom left corner at 1/4" high and in yellow on the 'Text' layer.

You don't really want your name jammed into the corner like that so move it up and over 1/8" (*Remember your **MOVE** command and relative points : @.125,.125*)

Dimensioning Objects

Now it's time to start dimensioning your drawing. Bring up the Layer dialog box and make **DIM** your current layer.

This is one time when I recommend to use the icons. Dimensioning is A LOT easier this way. If you don't see your dimensioning toolbar on the screen, right click on one of your toolbar icons and check the Dimension checkbox. You'll see the toolbar appear. Close the Toolbars dialog box.

There are several different types of dimensions, here are the ones you'll be using in this lesson (Each of the dimensioning icons gives you a quick clue as to which type of dimension it will create.) The image below shows you the standard dimensioning icons. This list below shows you which dimension types are available on the Dimension tool panel.

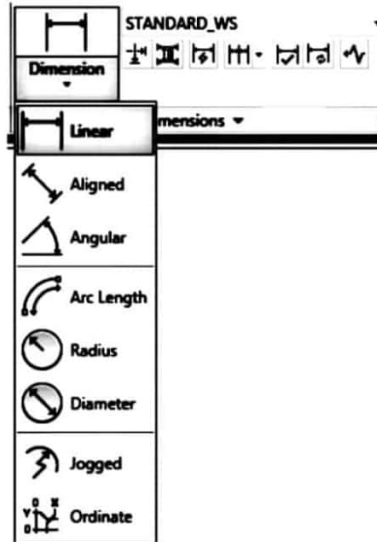

Here are the ones you'll be using in this lesson.

Linear dimensions are used for dimensioning either horizontal or vertical distances.

Aligned dimensions will measure the actual length of an angled line.

Radius dimensions will give you the radius of either arcs or circles.

Diameter dimensions are used on circles.

Angular dimensions will measure the angle between two lines that you pick.

Baseline dimensions are a special type that will automatically stack dimensions along one plane as you pick points.

Lab Task

Use Fillet, Chamfer and array commands to create the figure. Also dimension it and print the command line.

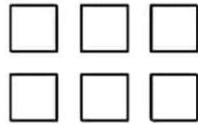
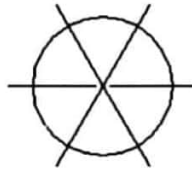
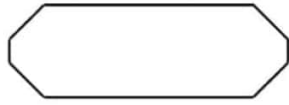



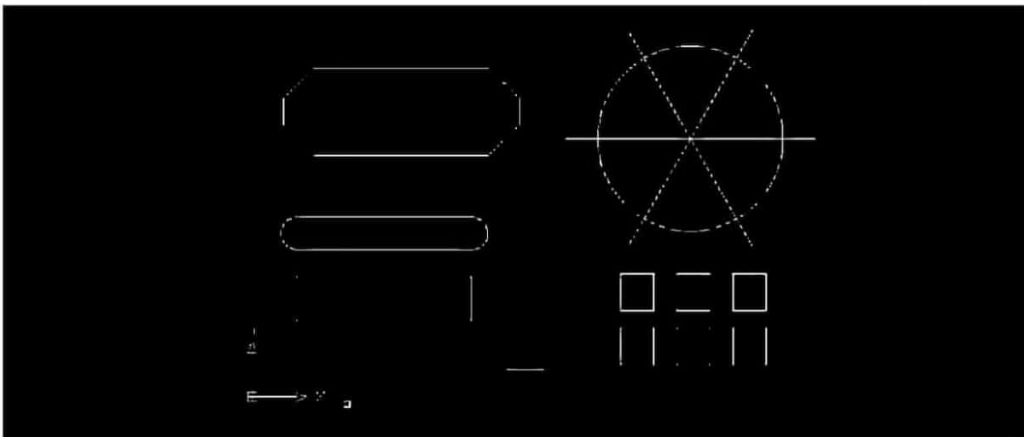

MY NAME – ASSIGNMENT #



Modify toolbar, extend, offset, trimming objects, move, copy, stretch, mirror of objects and some other modify commands.

In AutoCAD, you may actually use modifying commands more often than drawing commands. Now that you know the basics, here's some more commands to add to your collection. Three commands, Trim, Extend and Offset are used standard AutoCAD work.

Command	Keystroke	Icon	Location	Result
Rectangle	RECTANGLE / REC		Home > Draw > <u>R</u> ectangle	Draws a rectangle after you enter one corner and then the second.
Trim	TRIM / TR		Home > <u>M</u> odify > <u>T</u> rim	Trims objects to a selected cutting edge.
Extend	EXTEND / EX		Home > <u>M</u> odify > <u>E</u> xtend	Extends objects to a selected boundary edge.
Offset	OFFSET / O		Home > <u>M</u> odify > <u>O</u> ffset	Offsets an object (parallel) by a set distance.

Consider the following figures:

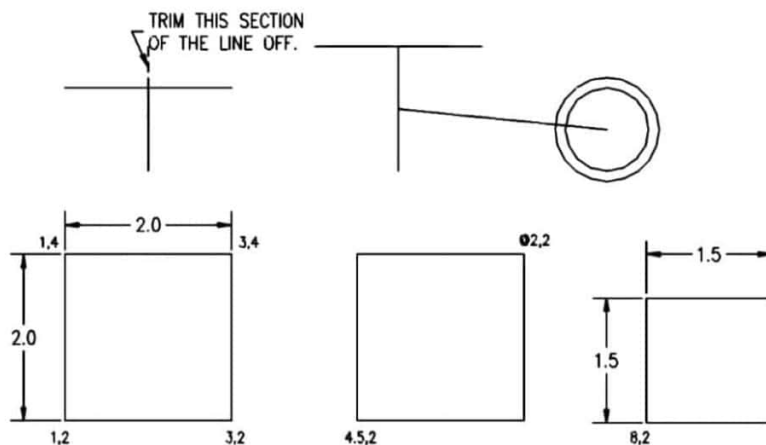

Draw a **LINE** from 1,2 to 3,2 to 3,4 to 1,4 (***Remember to watch the command line as you do this.**) For the last line's endpoint, you can either type in 1,2 or **C** to close the line back to the first point you entered. These are **absolute co-ordinates**. Make sure you understand what the points you just entered represent.

Draw the next square using the **RECTANGLE** command. A rectangle is created by specifying 2 points to represent the opposite corners. Enter the first point as **4,5,2** and then make the opposite corner 2 inches over and 2 inches up **@2,2** using **relative coordinates**. This is much faster and also makes the square **one object** and not 4 separate lines.

ERASE the rectangle. You will see that all of it is gone with **one pick**. Redraw it and continue.

For the 3rd square, draw a 1.5 x 1.5 unit square using any of the methods you know. The bottom left corner must be a **8,2**.

Draw a line from **2,5** to **2,6.5** Draw another line from **1,6** to **3,6** You should now have two perpendicular lines. What you want to do is trim off the top of the vertical line and create a T.

Start the **TRIM** command. It will first ask for a cutting edge. Select the horizontal line and press **<ENTER>**. It will now ask for the object to be trimmed. Select the vertical line anywhere above the horizontal (cutting) line and press **<ENTER>** to finish the command.

This is what you saw on the command line:

```
Command: TR <enter> TRIM
Current settings: Projection=UCS, Edge=None
Select cutting edges ...
Select objects: <Select the Horizontal line> 1 found
Select objects: <enter>
Select object to trim or shift-select to extend or
[Fence/Crossing/Project/Edge/eRase/Undo]: <Select the vertical line>
Select object to trim or shift-select to extend or [Project/Edge/Undo]: <enter>
```

Once again, it is important to keep your eye on the command line as it will guide you through most commands.

Draw a **LINE** from **4,6.5** to **6,6.5** Draw another line from **5,5** to **5,6** What you want to do now is **extend** the vertical line up to the meet horizontal line. Start the **EXTEND** command. AutoCAD asks for a boundary edge; select the horizontal line press **<ENTER>**. It then asks for an object to extend; select somewhere in the **top half** of the vertical line. Press **<ENTER>** to end the command. Your command line history should match what is shown below.

```
Command: EX <enter> EXTEND
Current settings: Projection=UCS, Edge=None
Select boundary edges ...
Select objects: <Select the horizontal line> 1 found
```





Select objects: <enter>

Select object to extend or shift-select to trim or [Fence/Crossing/Project/Edge/Undo]:

<Select the top half of the vertical line>

Select object to extend or shift-select to trim or [Project/Edge/Undo]: <enter>

Draw a **CIRCLE** with a center point of **7.5,5.5** with a radius of **.5** Now you will use to offset command to make another circle $\frac{1}{4}$ " larger. Start the **OFFSET** command (watch the command line) and enter **.125** as the offset distance ($\frac{1}{2}$ of $\frac{1}{4}$ "). Now select the circle and pick anywhere **outside** the circle. Press <ENTER> to end the command

Command	Keystroke	Icon	Location	Result
Move	Move / M		Home > Modify > Move	Moves an object or objects
Copy	Copy / CP		Home > Modify > Copy	Copies object(s) once or multiple times
Stretch	Stretch / S		Home > Modify > Stretch	Stretches an object after you have selected a portion of it
Mirror	Mirror / MI		Home > Modify > Mirror	Creates a mirror image of an object or selection set

Consider the figures:

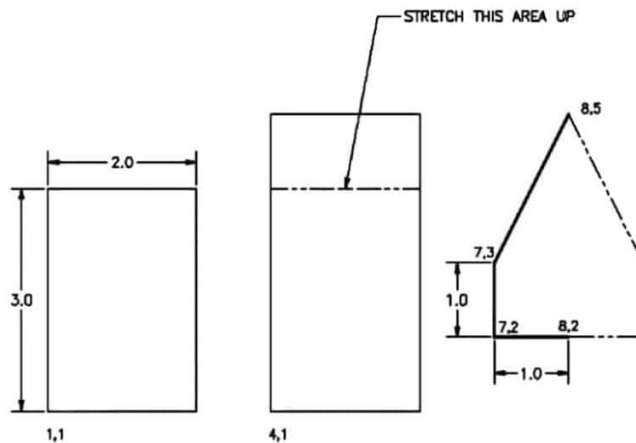

Draw a 2" wide by 3" high rectangle using the **RECTANGLE** command. The bottom left corner must be at **0,0**

Notice that the small rectangle and the border are overlapping each other at the bottom left of your drawing. What you want to do is move the small rectangle over 1" and up 1" so that it is away from the border.

To do this, start the **MOVE** command by typing in either **M** or **MOVE <ENTER>**. Select all the lines of the rectangle using one of the selection methods described earlier. Press **<ENTER>**. Now AutoCAD asks for a "base point or displacement". What it is needing is a reference point. Click on the bottom left corner of the rectangle. AutoCAD now asks for a 'second point of displacement'. What it needs to know now is how far you want to move it. This is a great time to use relative co-ordinates. In this case, you want to move it 1" over and 1" up. So type **@1,1 <ENTER>** to achieve this. The rectangle will automatically move to its new location.

Now you want to copy this rectangle 3" over to the right. The copy command is very similar to the move command. (The only difference is that the copy command leaves an original behind.)

Start the **COPY** command. And copy it **@3,0 <ENTER>** The rectangle has now been copied 3" over.

But the rectangle is not as tall as the one in the sample drawing, the sample drawing's rectangle is 1" taller. To modify this, you'll use the stretch command.

Start the **STRETCH** command by typing **S <ENTER>**. AutoCAD now makes you select objects by using a crossing window or crossing polygon. You're going to use a crossing window. Remember from the Lesson 1-5 that you make a **crossing window** by creating it from the right to left. Left-click just a bit above and to the right of the top right hand corner of the new rectangle (P1). Move your crosshairs down and to the left until your

(dotted) crossing window covers the top half of the rectangle completely and then left click again (P2). You'll see that the objects are highlighted now. Press <ENTER> to accept this. Next you're asked for that now familiar base point. Pick on the top left corner of the rectangle. Now give AutoCAD the second point of displacement. In this case, you want to stretch the rectangle 1" up, so type @0,1 <ENTER> to do this. The rectangle is now 1" taller.

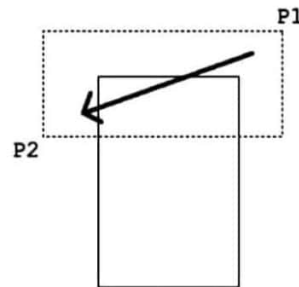

The goal when selecting objects to stretch is to draw the window over the vertices or points that you want to stretch. If you miss a corner, you will change the shape of the rectangle. So always be aware of which points need to be stretched. In this example, it was pretty obvious, in more complex drawings - it won't be.

Next you want to draw the polygon on the right side. To do this, you will draw the three lines on the left side first and then mirror those lines over to the right side. Draw the 3 lines any way you like (hint: use absolute co-ordinates)

Once they are drawn, begin the **MIRROR** command. Select the three lines (press <ENTER>) Now you are asked for the first point of the mirror line. With your endpoint Osnap turned on, pick the end of the line at 8,2. Now you are asked for the second point. Select the point on the line at 8,5. Once you've done this, AutoCAD wants to know if you want to delete the old objects. In this case you don't, so accept the default by pressing <ENTER>. The mirror line will be half-way between the object the you are mirroring and where you want it to be. Figuring out where the mirror line is the toughest part of this command.

Lab Task: Complete the above exercise on your own, also print the command prompt.

Lab 07:

Introduction to Blocks, Making blocks, Insertion of blocks



A block is a collection of objects (lines, arcs, circles, text, etc.) that form a more complex entity that normally represents an object in the real world, e.g. a door, a chair, a window, a computer.

There are many advantages to using blocks, here the major ones:

- Blocks are a single entity. This means that you can modify (move, copy, rotate) a block by selecting only one object in it.
- You can build up a library of blocks consisting of the parts that you require many times in your workday. These blocks can be stored in a separate folder and even on a network so that all drafters have access to them. Think of plumbing parts, valves, elbows, etc.
- Using blocks can help keep your file size down. AutoCAD stores block definitions in its database. When you insert a block, AutoCAD only stores the name of the block, its location (insertion point), scale and rotation. This can be very noticeable in large drawing.
- If you need to change something, you can redefine a block. For example, you draw a chair and turn it into a block. Later, you're told that the size of the chair has changed. Since you used a block you can redefine the block and all of your chairs are updated automatically. If you had drawn (or copied) 100 chairs in your drawing, you would have to manually change each one.
- Blocks can also contain non-graphical information. These are text objects called **attributes**. For example, you have made blocks of different chairs. You can add information to the block such manufacturer, cost, weight, etc. This information stays with the block, but can also be extracted to a database or spreadsheet. This would be useful for things such as a bill of materials. Attributes can also be visible or invisible in your drawing. Another good use of attributes could be a title block.
- You can even easily add internet hyperlinks to blocks so you can connect a block to a page on a supplier's online catalog.

The commands that you will need for using blocks in this lab:

Command	Keystroke	Icon	Location	Result
Block	Bmake / B	 Create	Home > Block > Create	Creates a block from separate entities (internal to current drawing)

Write Block	Wblock / W	None	None	Creates a block and writes it to a file (external)
Insert	Insert / I	 Insert	Home > Block > Insert	Inserts a block (internal or external)
Explode	Explode / X		Home > Modify > Explode	Explodes a block or other compound object into its component parts

NOTE: Zero Layer has special properties. When creating blocks, if the objects in the block are drawn on Zero layer, they will assume the properties of the current layer when they are inserted. Example: If you draw the computer below on Zero layer, and insert it on the 'COMPUTERS' layer, it will assume the color, linetype and lineweight of the Computers layer. If you drew and created it on the 'DOOR' layer, and inserted it in the Computers layer, it would retain the properties of the Door layer. For this reason, blocks are drawn on the Zero layer.

Draw the computer as shown below. You do not have to dimension it.

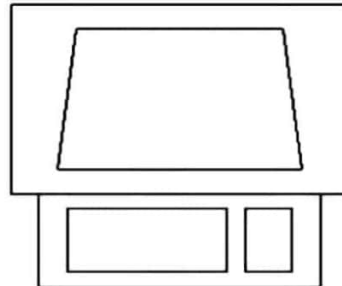

Start the **BLOCK** command by either typing **B** or using the pull down menu or the icon. You will see a dialog box that looks like the one shown. Enter information the same way though. Remember to approach all new dialog boxes from the top and work your way down.

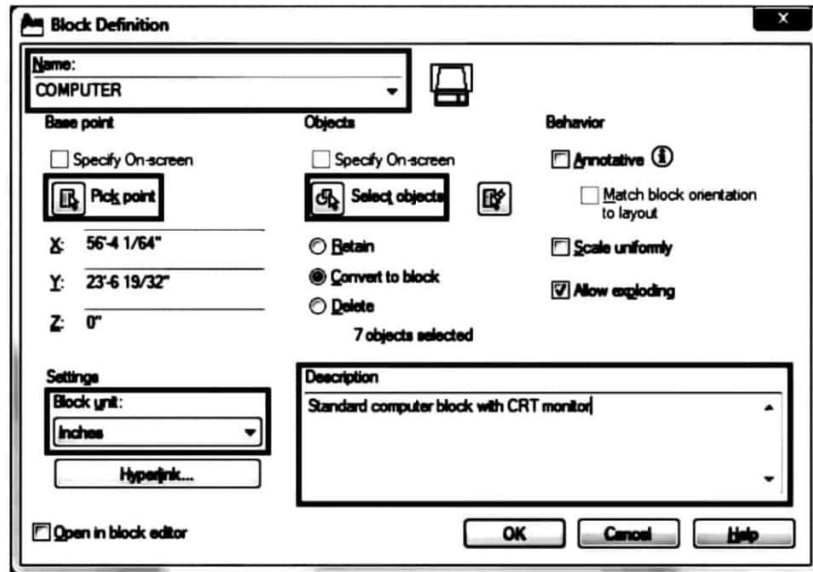

1 : The first thing that you want to do is give your block a name. Type **COMPUTER** in the edit box beside Block Name. Some names may need to be more descriptive, such as part number, or size.

2 : Now you need to select an insertion/base point. Pick the **Pick Point** button and then pick the midpoint of the bottom line. Make sure that the retain button is selected (this will keep your objects on the screen as individual objects. (You will see in a moment that selecting the Pick Point with blocks is very important when you later insert them into the drawing - always pick a point that will allow you to place the block easily.) If you don't select a base point, your block will default to 0,0,0 and you will insert all your blocks at the same location - the origin.

3 : Next you want to select the objects for your block. Pick the **Select Objects** button and then select all the parts of your computer and press **<ENTER>**. Be careful not to select any other objects, or you just get to do it over again.

4 : Now select the drawing units you used to create the original objects in.

5 : This is optional, but you can add a description here. This is good if you are creating specific parts, like maybe a motor and want to add some quick specifications. It's also great if co-workers know what the block is used for (more information = better).

6 : Pick the OK Button and the dialog box closes. It will look like nothing happened, but the drawing file now has a "Block Definition" for a Computer in it. Congratulations, you have created your first block.

If the default radio button "Convert to block" was checked, move your mouse over the objects and you will see that they all highlight - signifying that it is now one object.

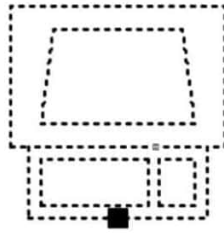

Now that you have created a block, it's time to insert it. Change to the Computer Layer. Start the Insert command by typing **I** <ENTER>. You will see this dialog box on the screen:

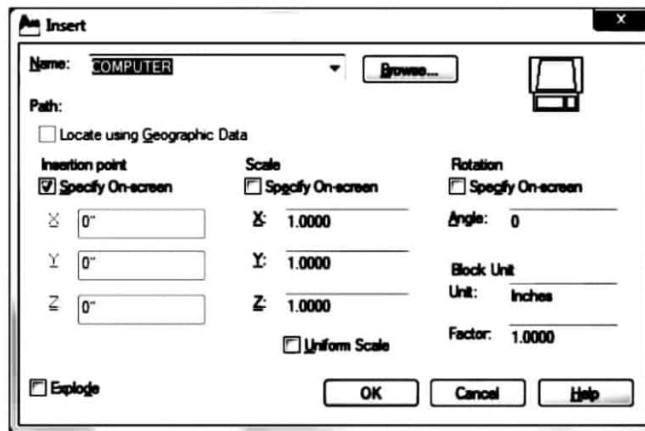

By default, all the options you need are pre-selected. Since you only have one block in your drawing, its name is displayed.

Make sure that the **Insertion Point - Specify On-screen** box is checked, and the **Explode** button is **not** checked. The **Scale - Specify On-screen** should not be checked. Then press the OK button. Pick anywhere on your screen and you will see the block appear. Notice how the block that you drew on the white Zero Layer is now Red and on the Computer layer.

Now insert a computer on every desk in your drawing. You can also copy the block instead of re-inserting each time, but make sure you know how to insert.

Lab Task:

Draw the electrical symbols for the below mentioned electrical components using blocks:

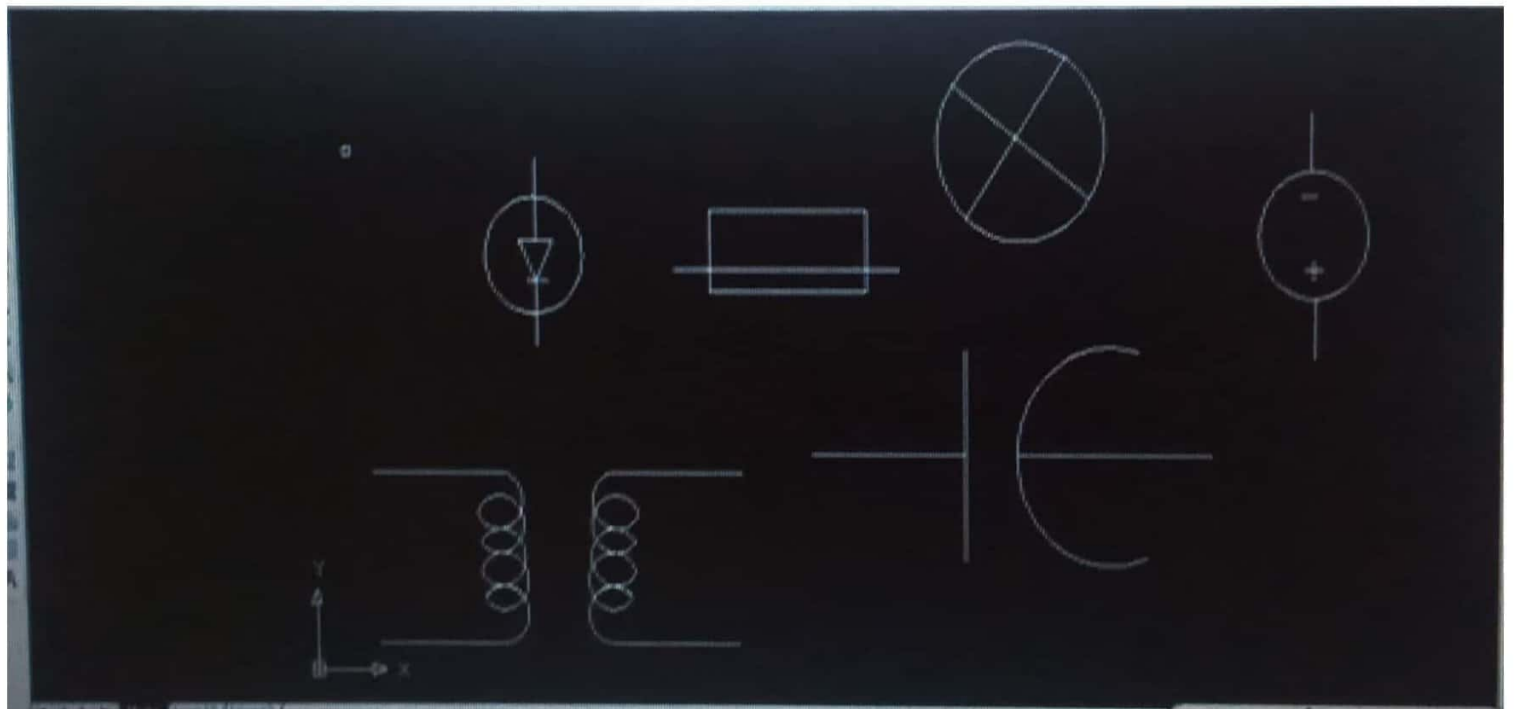

- a) Capacitor

- b) Transformer
 - c) Diode
 - d) Bulb
 - e) Fuse
 - f) Dc voltage source
-



Lab 08: Hatching and Gradients

Hatching in AutoCAD is a way of filling in areas of your drawing with a pre-formatted pattern to represent certain materials. It is usually used in sectional views. Starting with AutoCAD release 14, you can use a solid fill to completely fill in areas such as walls in a floor plan.

Command	Keystroke	Icon	Location	Result
Boundary Hatch	Bhatch / H		Home > Draw > Hatch	Covers an area with a predefined pattern
Hatch Edit	HatchEdit / HE		Home > Modify > Edit Hatch	Edits an existing Hatch
Solid	Solid / SO	None	None	Creates a solid filled shape

Draw a rectangle 10" by 10" and put a circle with 2" radius in the middle of it (remember the **M2P** OSnap?).

Start the Boundary Hatch by typing **H <ENTER>** . When you start the command, you will see this dialog box appear:

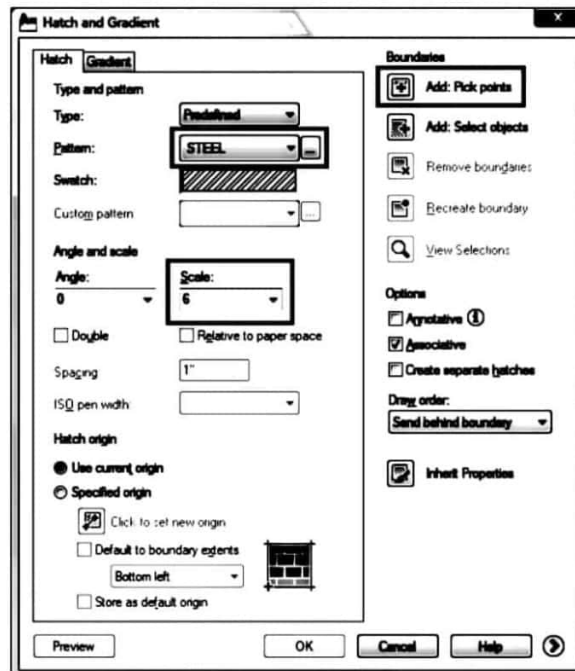

As usual, start at the top of the dialog box and work your way down. We're going to say that this is a cross section of piece of steel, so choose the predefined Hatch pattern called **STEEL**.

Now you want to pick the area to be hatched. **Pick** somewhere inside the rectangle, but outside of the circle and press **<ENTER>**.

Set the scale of the hatch to **6**. This is just a number that works for this object. A larger number will make the hatch bigger (maybe so big you won't see it) and a smaller number can make the hatch so dense that it looks solid (try different numbers later to see if I'm wrong).

Make this "**Associative**" - this means that if you adjust the rectangle or circle, the hatch will automatically correct itself to the new boundary.

Finally, hit the **Preview** button to see if this is what you are after, it should match the image below.

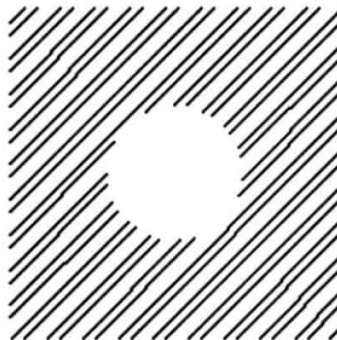

Note that AutoCAD recognized the circle in the middle and didn't hatch over it. If the lines appear 'jagged', don't worry - it is a video display issue -the prints will come out clean and straight.

If you want to edit the hatch, the easiest way is to just double-click on it. (If you can't double-click on it, type in **HE <ENTER>**). This will bring up the same dialog box (almost) that you just used to create the hatch. Try different settings in the Hatch Edit dialog box and preview the results.

To see what "Hatch Association" is, pick on the rectangle (be careful not to select the hatch) and you'll see 4 squares appear on the corners. Click and drag one of the corners and release it. If you hatch is associative, it will update to the new shape.

You can also add a 2 color gradient to an object. Look for the "Gradient" tab at the top of the Hatch dialog boxes. Below is a sample of a really basic 2D 'rendering' using this method. Pick on the gradient tab of the hatch dialog box.

Lab Task:

Draw the below figure and hatch it according to the given pattern.

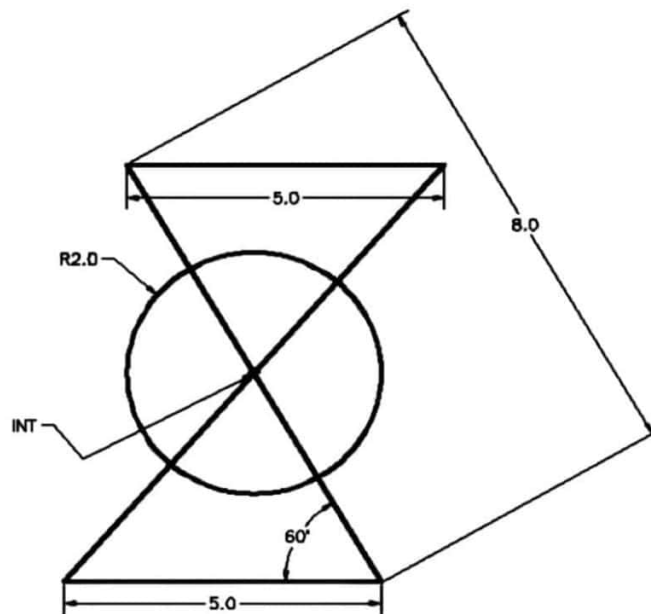

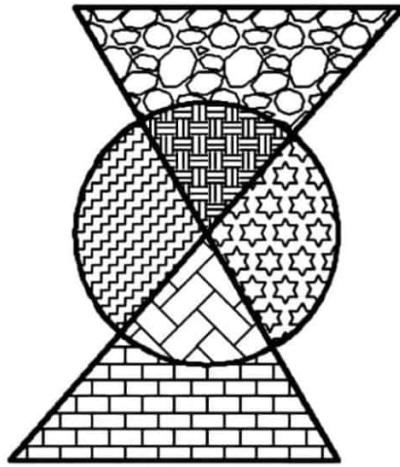

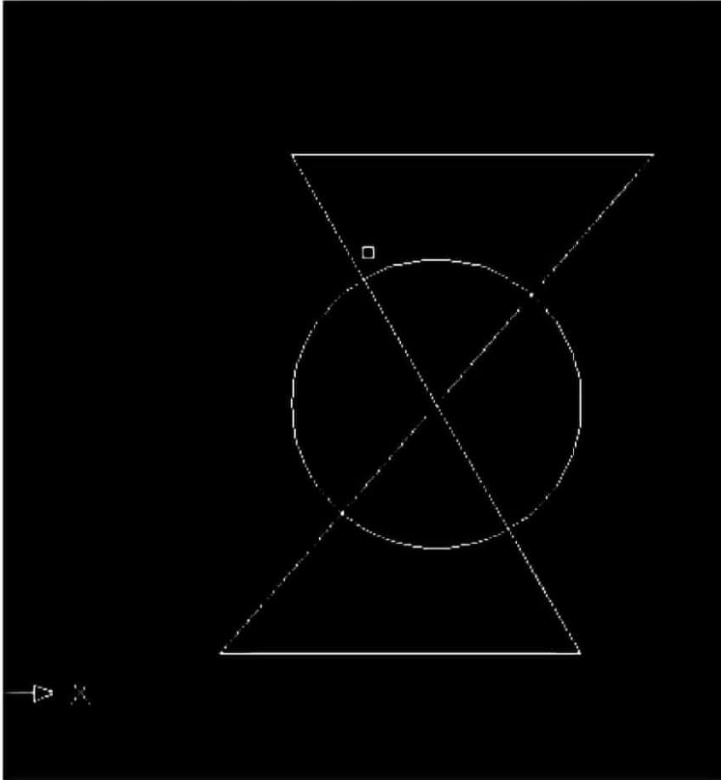

Lab 09:

Overview of 3-D coordinate system. Rotation in 3-D

THE 3-D CO-ORDINATE SYSTEM

By now you should be very comfortable working your way around the X-Y co-ordinate system. Anyway, here is a quick review. Looking from the plan (top) view, this is what you see to figure out where is positive X and positive Y.

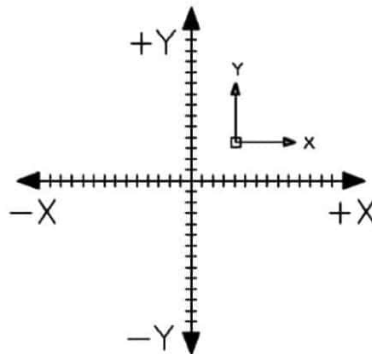

If you were to look at the same picture, but at a slight angle, you would see the third axis. This new axis is called the Z-axis. Imagine that the positive Z-axis is coming towards you out of the monitor.

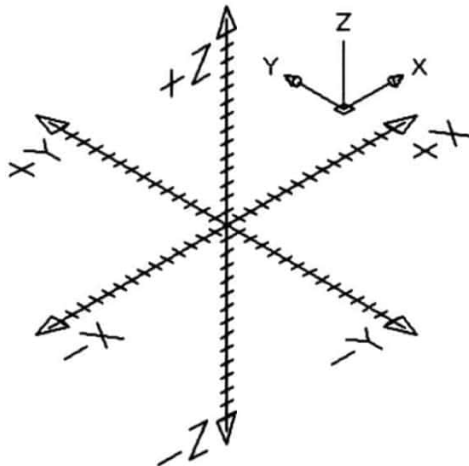

The Z-axis has always been there, *lurking in the background*, waiting for you.

When you entered points previously, you would enter them in the format: **X,Y**. By doing this, you let AutoCAD know that in these cases, Z was equal to zero. Entering **4,3** would be the same as entering **4,3,0**. Now if you drew a line from the origin (**0,0,0**) to a point at **4,3,2**, you would get a line that goes 4 inches to the right, 3 inches up and 2 inches towards you. The properties of this line would be this:

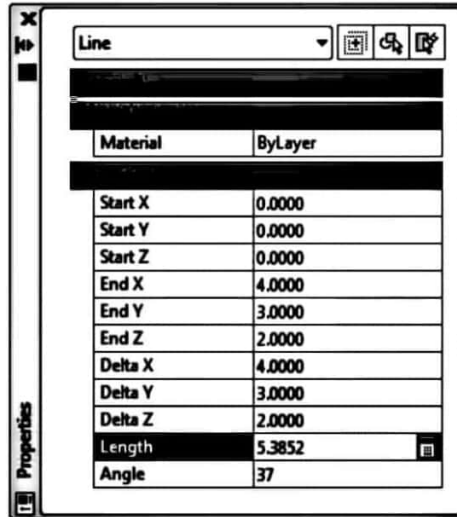

Material	ByLayer
Start X	0.0000
Start Y	0.0000
Start Z	0.0000
End X	4.0000
End Y	3.0000
End Z	2.0000
Delta X	4.0000
Delta Y	3.0000
Delta Z	2.0000
Length	5.3852
Angle	37

Notice that the line is actually **5.3852"** long. If you were to look at it from the plan view, it would look exactly like a line drawn from **0,0** to **4,3**. Draw a line from 0,0 to 4,3 and then compare the properties.

The diagrams below, show this line from 4 different views to illustrate how things can look different in 3D. Look at each one carefully, and see if it makes sense to you.

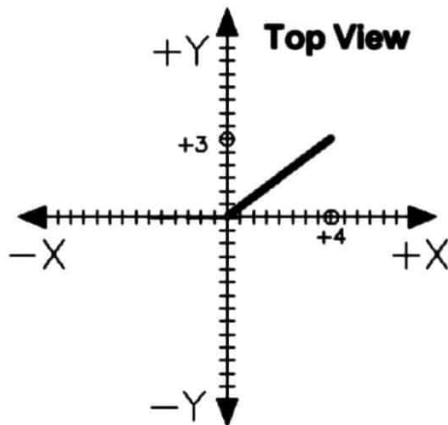

This is the usual view you have seen when using AutoCAD in 2D. You are looking straight down the Z axis (positive Z is pointing at your). It looks like any other line you have drawn, going from 0,0 to 4,3 - but there is a difference...

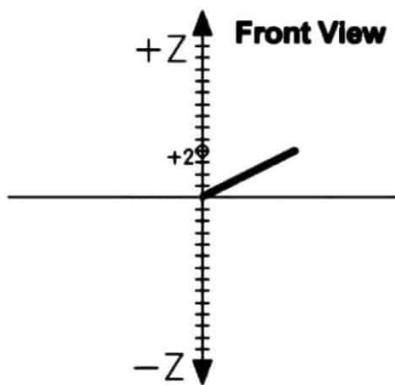

If you were to look at the line from the front, instead of the top (as shown above) you would be able to notice the elevation of 2 units in the Z axis. This is the same line as above, only viewed from a different angle. In this view, you are looking straight down the -Y axis.

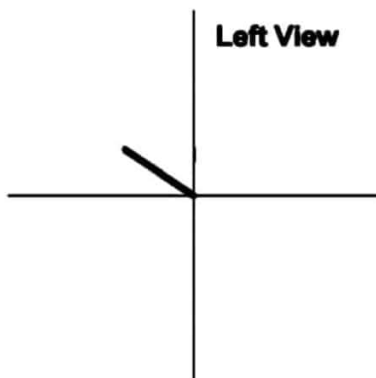

Just for fun, here is the same line but viewed from the left. This would be looking down the -X axis.

Southeast View

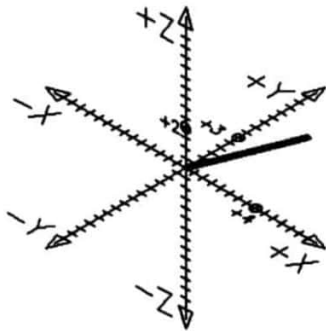

Finally, here is the line as viewed in 3D space from the Southeast view. This is where viewing 3D objects on a 2D monitor gets tricky. You need to visualize

3D Rotation

Now for the confusing part. You already know how to rotate 2D objects, but you also have to know how AutoCAD measures angles of rotation in 3-D. There is a somewhat simple rule for this called "The Right Hand Rule". To figure out which is the positive rotation angle, imagine that you are wrapping your right hand around the axis with your thumb pointing towards the positive end. The direction that your fingers are wrapped is the positive direction. This applies to all three axes.

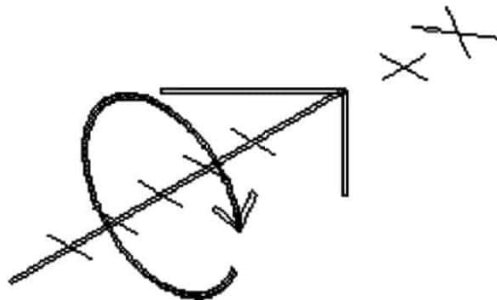

DIRECTION OF POSITIVE ROTATION

The main point of this lesson is to tell you that objects can trick you in 3D space. Shortcuts don't always work, you have to be careful with Osnaps and **your drawing can turn into a mess very quickly if you're not paying attention.** Trust me, I've seen

enough students take the easy route and have to start over. If you want to learn 3D, review each lesson before progressing. Make sure you know the concepts inside and out.

Lab Task:

Draw the below given figure in AutoCAD using SW Isometric view.

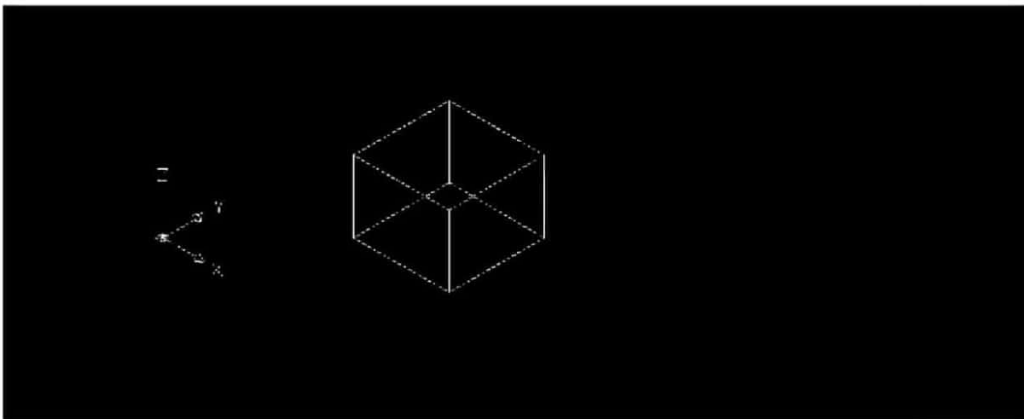
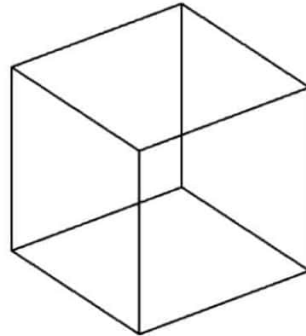

Lab 10:

Working in 3-D Wireframe Model

Wireframe models are the simplest form of true 3D drawings. They can be used for conversion to other programs or other simple uses. Still, this is not a common way of drawing in 3D these days. This exercise is good practice to work on the XYZ co-ordinate system.

Start a new drawing using the acad.dwt template.

Create a layer called **OBJECT** and give it a green color. Make this your current layer.

Using the **line** command, draw the outline of the front view placing the bottom left corner at **0,0,0** Then draw the circle.

Copy the outline and circle 2" up in the Z-axis. When asked for the base point, select anywhere on the screen, and copy it relative to the base-point: **@0,0,2 (X,Y,Z)**

Switch your view to the SW Isometric view.

Notice that you have the front and the back drawn now. Using your endpoint Osnap, connect the corners of the object.

Your finished drawing should look like this:

Pick any line and snap to an endpoint grip. Look at the co-ordinate display on the left of your status bar and see if it makes sense to you. Try this at other points. What you have just done is created a simple object in 3D drawing space. It has length, depth and height. Get used to looking at it, and review what you did to create it.

Save your drawing under the name wireframe1.dwg.

Practice:

Start a new drawing using the acad.dwt template.

Create 3 layers called **SIDES**, **SEAT**, and **BACK** and give them different colors. Make back your current layer. Multiple layers make your drawing easier to work with.

Look at the drawing below. This is the basic chair shape that you will be drawing a few different ways in this course. For this lesson, you'll be using rectangles. Switch to your SE Isometric view.

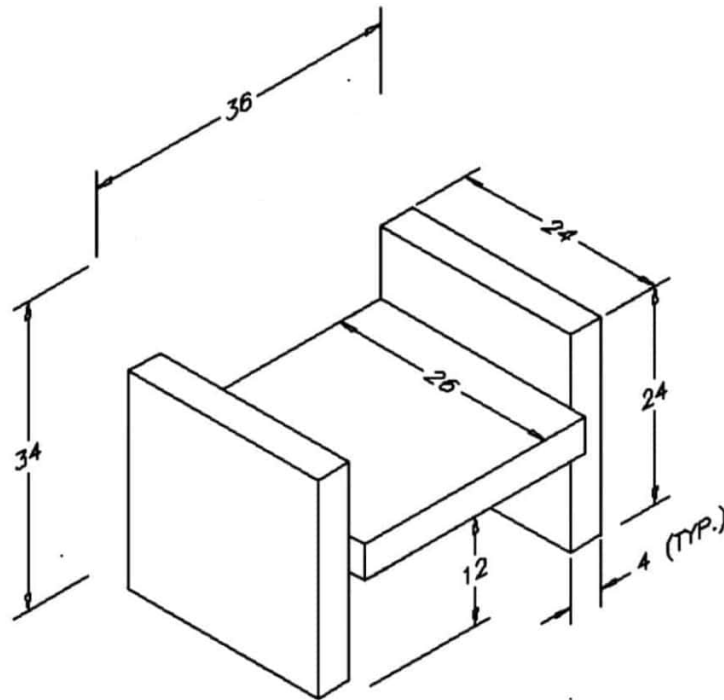

Start with the back. Make rectangle to define the plan view of the back of the chair. Copy it 34" in the Z-axis and then connect the corners with vertical lines.

Next draw the sides (on the sides layer). Use the same method you used for drawing the back (except copy them up 24")

Once you have drawn one side, you can copy or mirror it to make the other side.

Finish up by drawing the seat. This will take a bit of thought as you have to make it fit between the sides. Start by drawing the rectangle for the seat in the correct location, then move it up 12" so that it is at the correct elevation. After that, copy it up 4" and connect the corners.

Save the file as wireframe2.dwg in your CAD folder.

Try to get the viewport configuration you see below using tiled viewports

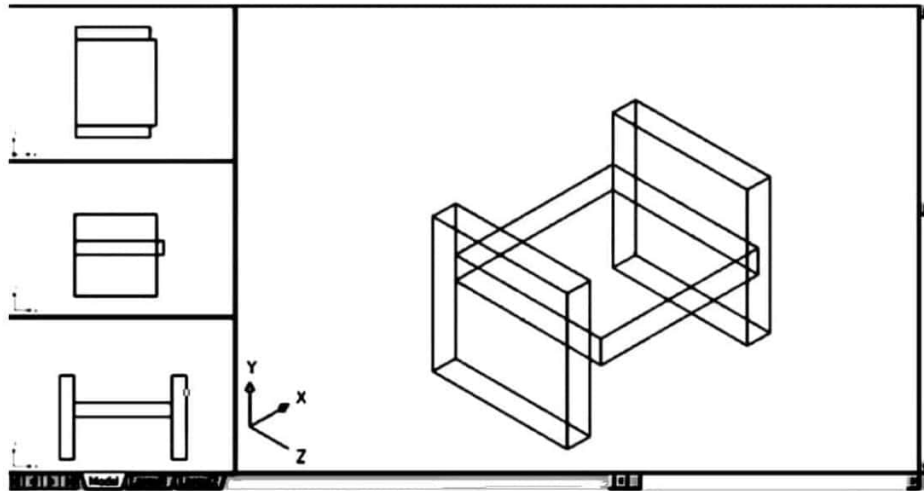

You don't need to dimension this drawing, but use the **Distance** command to confirm that the sizes are correct.

When you are sure that your drawing is correct, save it again for later use.

From these simple exercises, you can see that the world of 3D (so far) isn't really different from 2D. You used the same rectangle, line, copy, move commands that you would drawing in a 2D world. The only difference is that you added the Z co-ordinate to give your point 'height'. Once again, make sure you are familiar with what happened in this lesson before moving on to the next. Redo it if you have to, but get used to the concept of height.

Lab Task:

Draw the following figures using wireframe model:

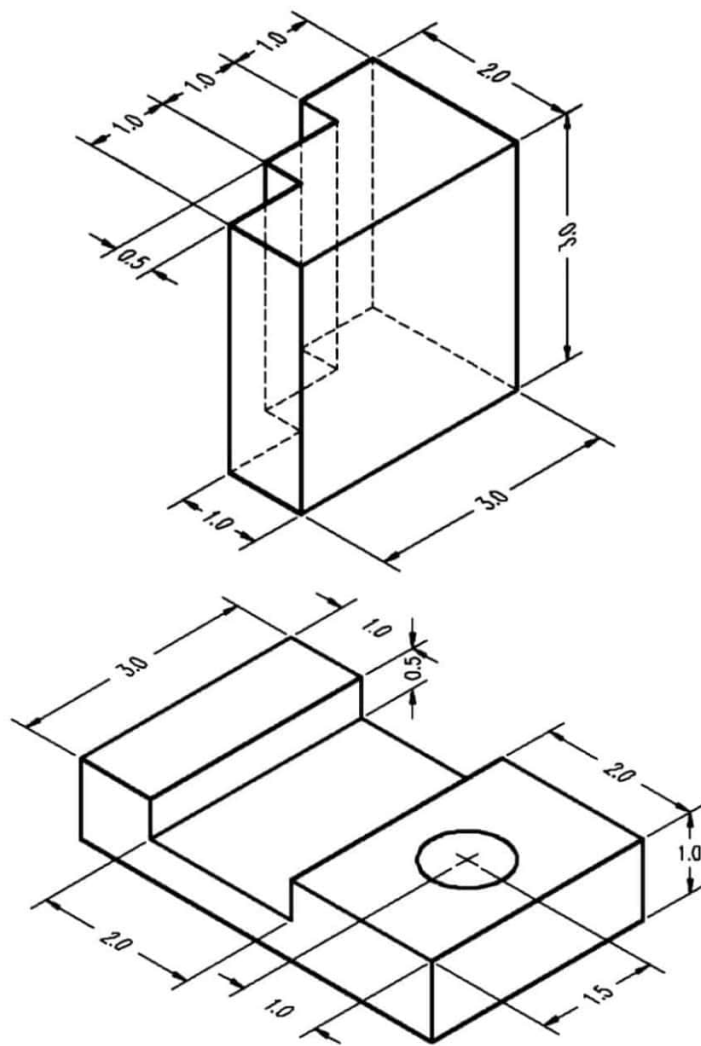

Iqra national university Peshawar

Open ended lab

Name	M.zeeshan
Id	16529
Semester	2nd
Subject	Engineering Drawing
Department	BE-Electrical
Submitted to	Sir Zulqarnain sb
Date	15/06/2020

Introduction:

The objects around us come in various shapes and sizes. In general, we can see shapes such as triangles, squares, and circles everywhere around us. Moreover, shapes such as a sheet of paper, have only length and breadth. Thus such shapes are 2D or two-dimensional. While other shapes such as the shape of a house, have length, breadth, and height. Thus such shapes are 3D. Let's learn more about 2D and 3D shapes!

Block daigram 3D:

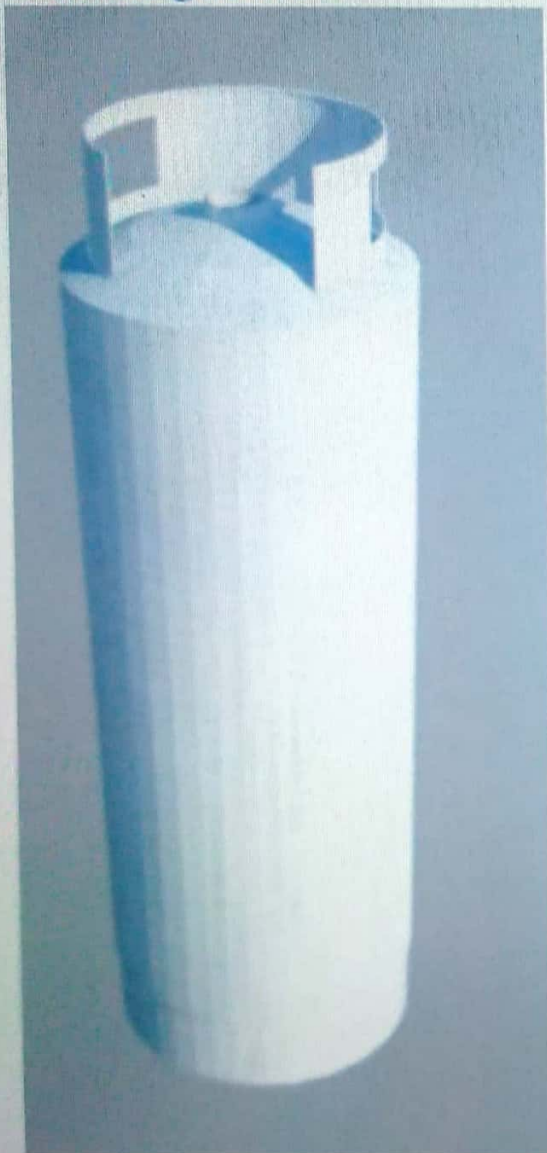

Circuit daigram 2D:

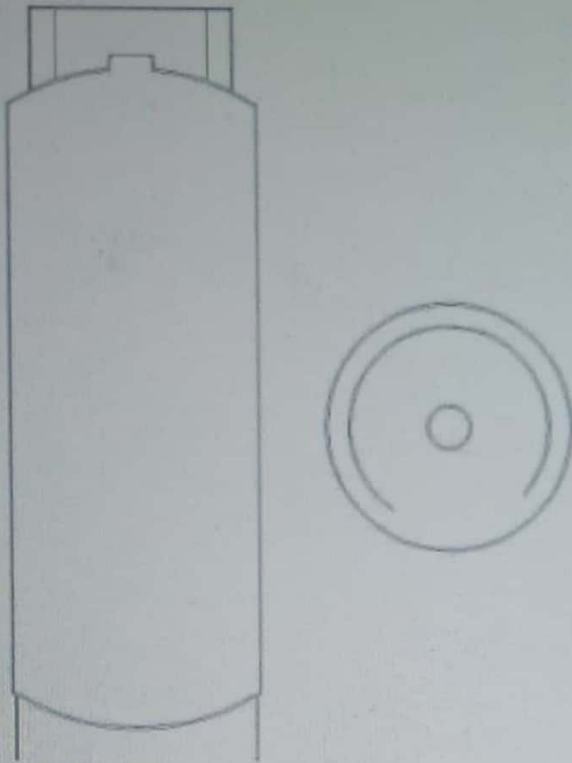

Component used:

- Head Gasket. The head gasket, usually made from a thin piece of steel, seals the joint between the engine block and the cylinder head. ...
- Exhaust. Your car runs on the ignition of a mixture of fuel and air. ...
- Valves. ...
- Spark Plug Mounts. ...
- Camshaft

Working of project:

1. Click Home tab Modeling panel Cylinder. Find.
2. At the Command prompt, enter e (Elliptical).
3. Specify the start point of the first axis.
4. Specify the endpoint of the first axis.
5. Specify the endpoint (length and rotation) of the second axis.

6. Specify the height of the cylinder.

Command:

You can control the smoothness of curved 3D solids, such as a cylinder, in a shaded or hidden visual style with the FACETRES system variable. During a drawing session, the default value for the base radius is always the previously entered base radius value. The following prompts are displayed