

DIGITAL LOGIC DESIGN

Assignment 4
Sir. Muhammad Amin



HASSAN MEHDI

15453
Csc-201

Ans Q 1:

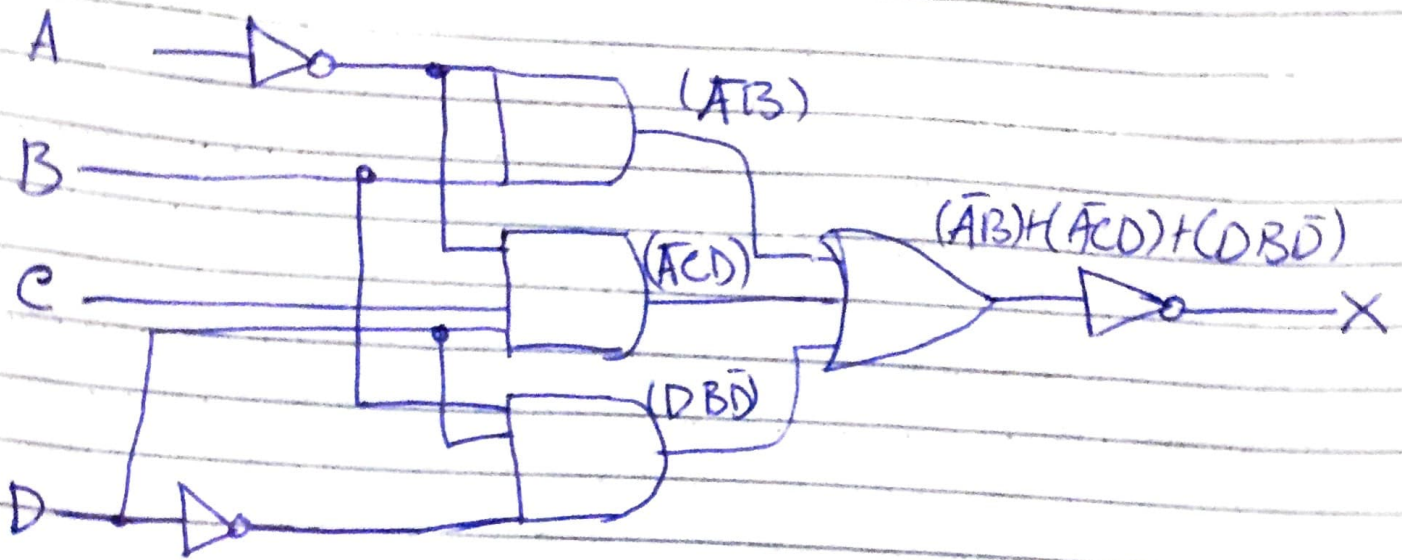

$$X = (A\bar{B}) + (ACD) + (DB\bar{D})$$

Ans

Ans Q 2:

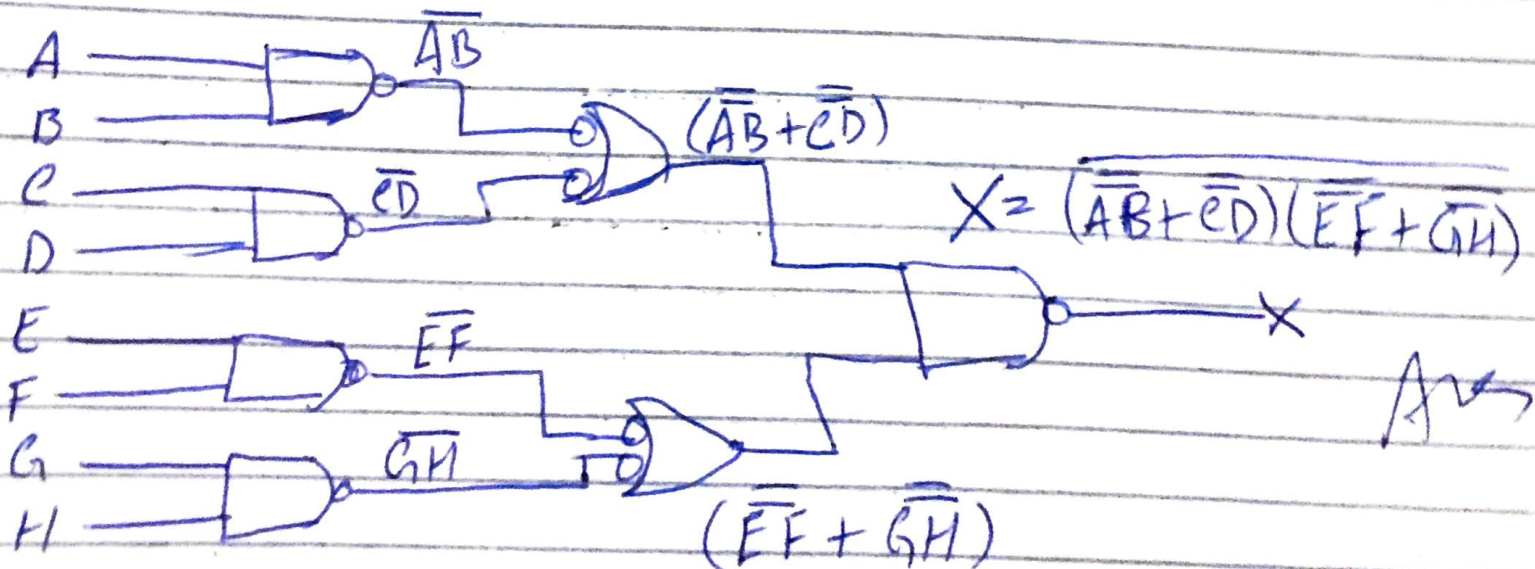

Ans

Using De-morgan's Law to Convert the given expression into And-OR equivalent.

$$z = \overline{(\overline{AB} + \overline{CD})(\overline{EF} + \overline{GH})}$$

$$\overline{(AB + CD)(EF + GH)} \Rightarrow \overline{A} = A$$

$$\overline{(AB + CD) + (EF + GH)}$$

$$\overline{AB} = \overline{A + B}$$

$$\overline{(A\overline{B}CD) + (\overline{E}F\overline{G}H)}$$

$$\overline{A+B} = \overline{A}\overline{B}$$

$$\overline{(A+B)(C+D) + (E+F)(G+H)}$$

$$\overline{AB} = \overline{A}\overline{B}$$

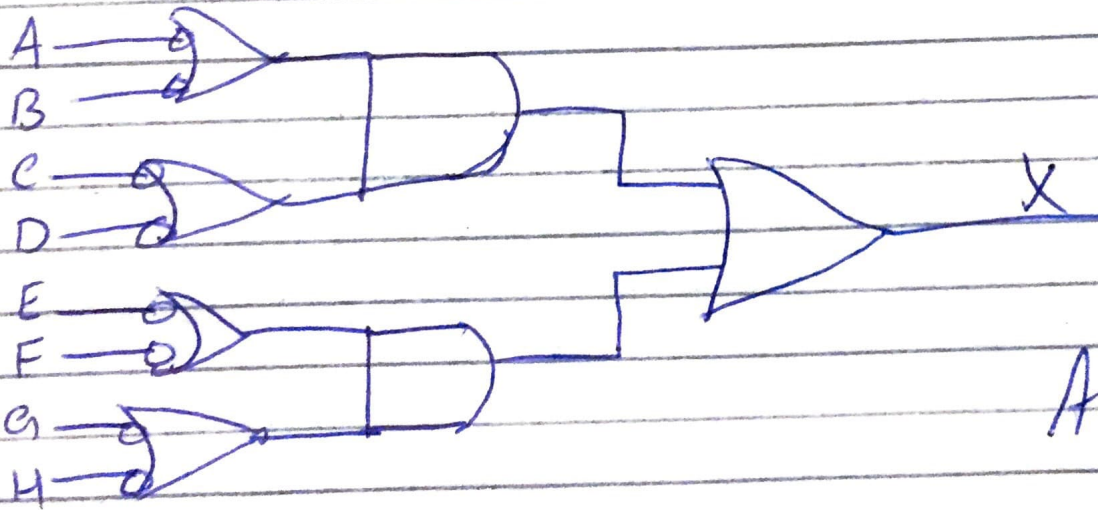

Ans

Ans Q 3:

Ans Q 4:

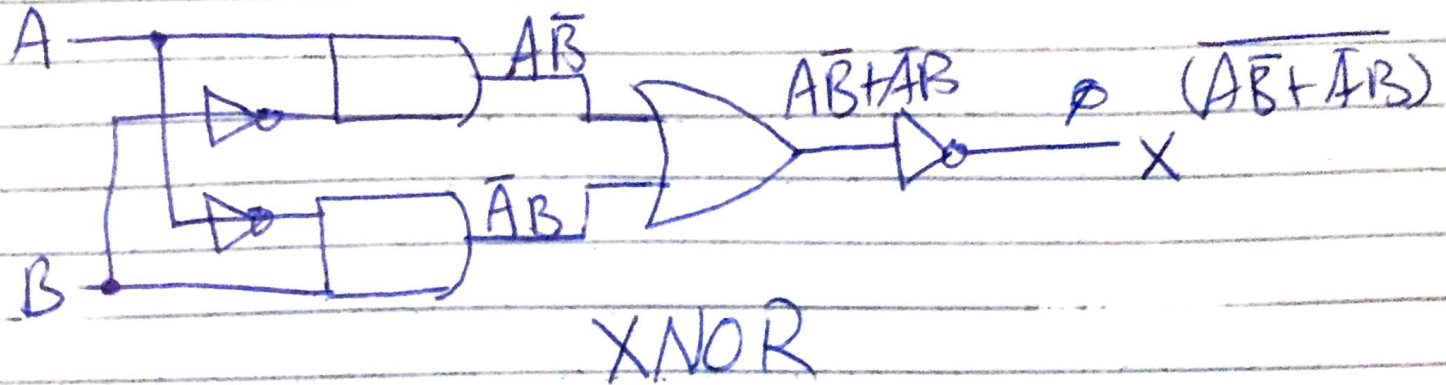

$$X = \overline{A\bar{B} + \bar{A}B} \quad \text{Ans}$$

Ans Q 5:

$$X = ABC(B+E+F) + AC(C+D+E)$$

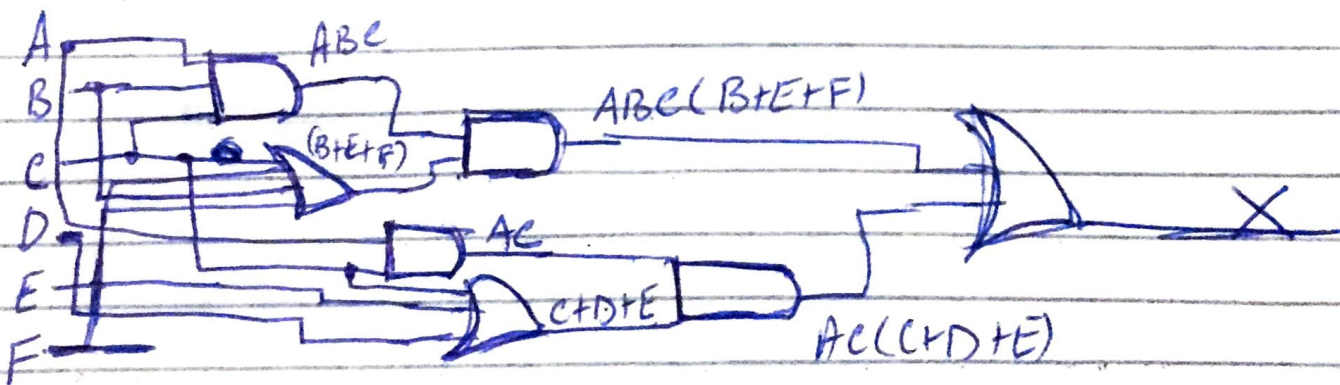

Ans Q 6:

$$X = B[(C\bar{D}E) + (\bar{E}FG)](\bar{A}B + C)$$

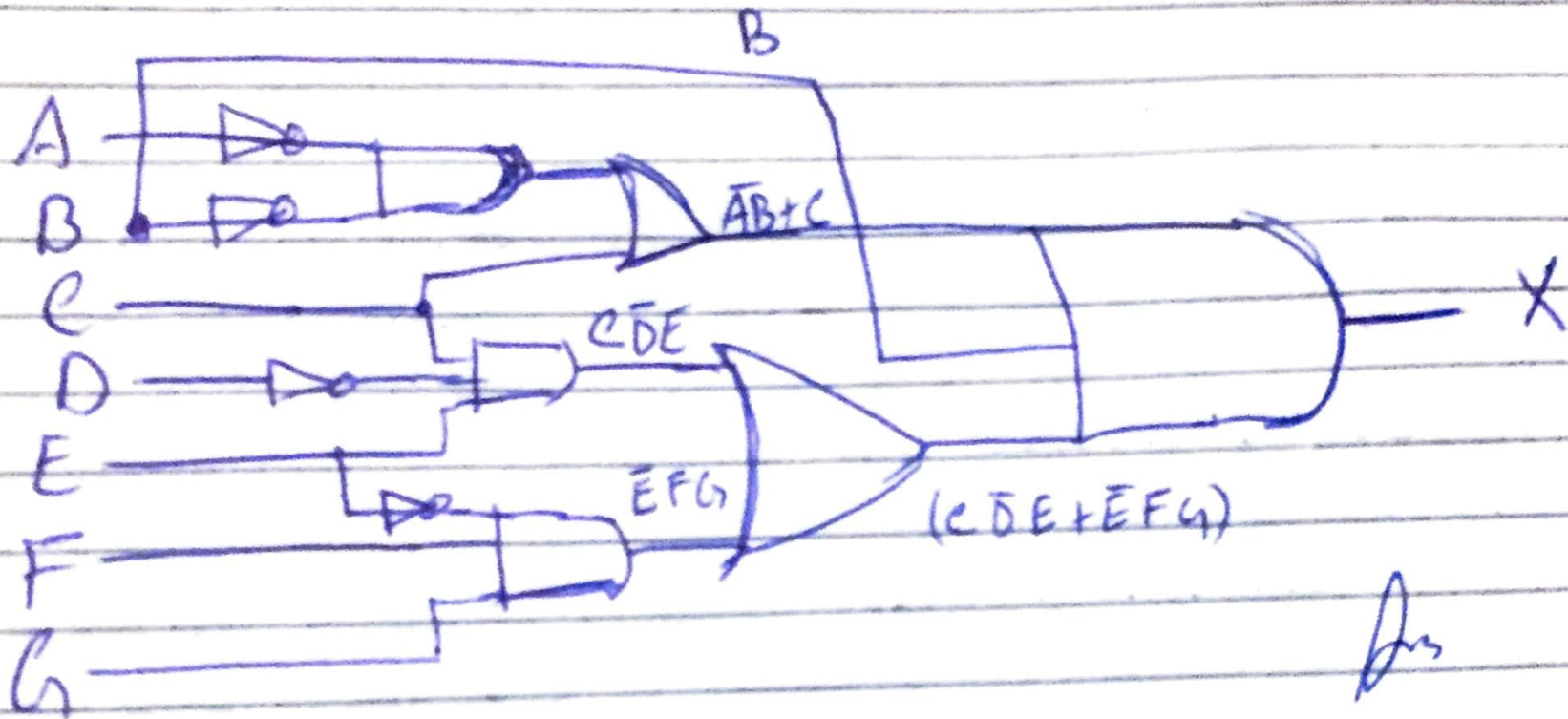

Ans Q 7:

$$X = \bar{A}B + CD + \bar{A}B(A + B)(ACD + \bar{B}E)$$

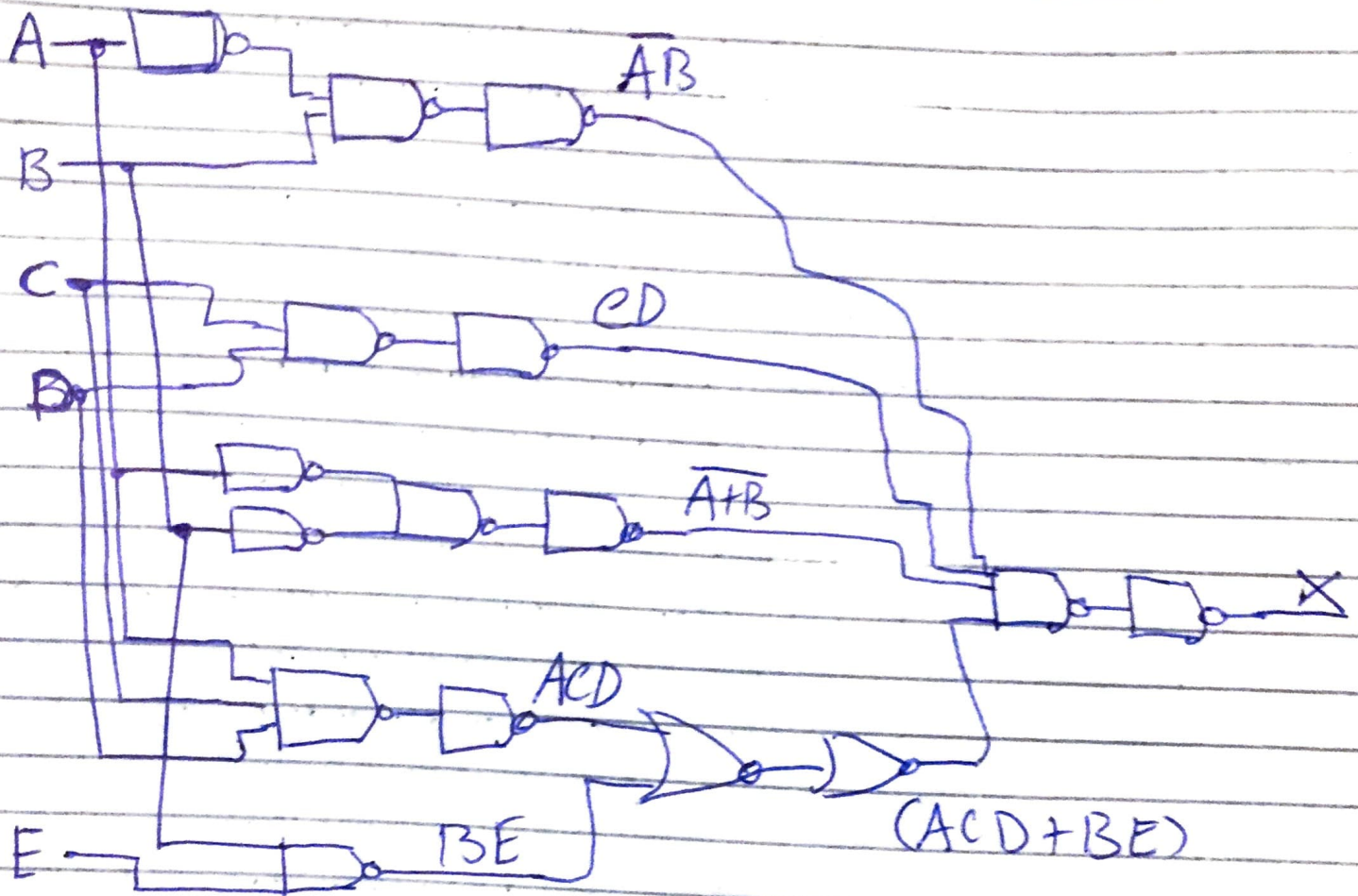

$$X = \bar{A}B + CD + \bar{A}\bar{B}(ACD + BE)$$

Ans @ 8:

$$Y = (\bar{A}\bar{B}C\bar{D}) + (\bar{A}B\bar{C}D) + (\bar{A}B\bar{C}\bar{D}) + (A\bar{B}C\bar{D}) + (\bar{A}\bar{B}\bar{C}D) + (\bar{A}\bar{B}C\bar{D}) + (A\bar{B}C\bar{D}) + (A\bar{B}C\bar{D})$$

Ans Q 9:

$$X = \overline{AB(B+C)} + C$$

By simplifying X , we get

$$AB + C$$

~~A B C AB \overline{AB} $\overline{B+C}$ \overline{C}~~

A	B	C	AB	\overline{AB}	$\overline{B+C}$	\overline{C}	AB + C	$\overline{AB} \cdot \overline{B+C}$	$\overline{AB(B+C)} + C$
0	0	0	0	1	1	1	0	1	0
0	0	1	0	1	0	0	1	0	1
0	1	0	0	1	0	1	0	0	0
0	1	1	0	1	0	0	1	0	1
1	0	0	0	1	1	1	0	1	0
1	0	1	0	1	0	0	1	0	1
1	1	0	1	0	0	1	1	0	0
1	1	1	1	0	0	0	1	0	1

Ans Q 10:

$$X = B[(CDE) + (EFG)](\bar{A} + \bar{B} + C)$$

2

$$B(CDE + EFG)(\bar{A} + \bar{B} + C)$$

$$(BCDE + BEFG)(\bar{A} + \bar{B} + C)$$

$$\bar{A}BCDE + \bar{A}BEFG + \bar{B}BCDE + \bar{B}BEFG$$

$$+ BCDE + BEFG$$

$$\bar{A}BCDE + \bar{A}BEFG + 0(CDE) + 0(EFG) \\ + BCDE + BEFG$$

$$= \bar{A}BCDE + \bar{A}BEFG + BCDE + BEFG$$

Ans

Ans Q 11:

$$X = \bar{A}B + CD + (\bar{A} + \bar{B})(ACD + BE)$$

$$\bar{A}B + CD + (\bar{A}\bar{B})(ACD + BE)$$

$$\bar{A}B + CD + \bar{A}\bar{B}ACD + \bar{A}\bar{B}BE$$

$$\bar{A}B + CD + 0(\bar{B}CD) + \bar{A}\bar{B} + \bar{A}\bar{B}BE$$

$$\bar{A}B + CD + \bar{A}\bar{B} + \bar{A}\bar{B}BE \quad \text{Ans}$$

Ans Q 12:

$$X = \overline{(\overline{AB + CD})(\overline{EF + GH})}$$

Sol $(\overline{AB + CD})(\overline{EF + GH})$

$$= \overline{(AB + CD)(EF + GH)}$$

$$\overline{AB} \overline{CD} + \overline{EF} \overline{GH}$$

$$(\overline{A+B})(\overline{C+D}) + (\overline{E+F})(\overline{G+H})$$

$$\overline{A}\overline{C} + \overline{A}\overline{D} + \overline{B}\overline{C} + \overline{B}\overline{D} + \overline{E}\overline{G} + \overline{E}\overline{H} + \overline{F}\overline{G} + \overline{F}\overline{H}$$

As

Ans Q 13:

$$X = \overline{AB + ACD + DBD}$$

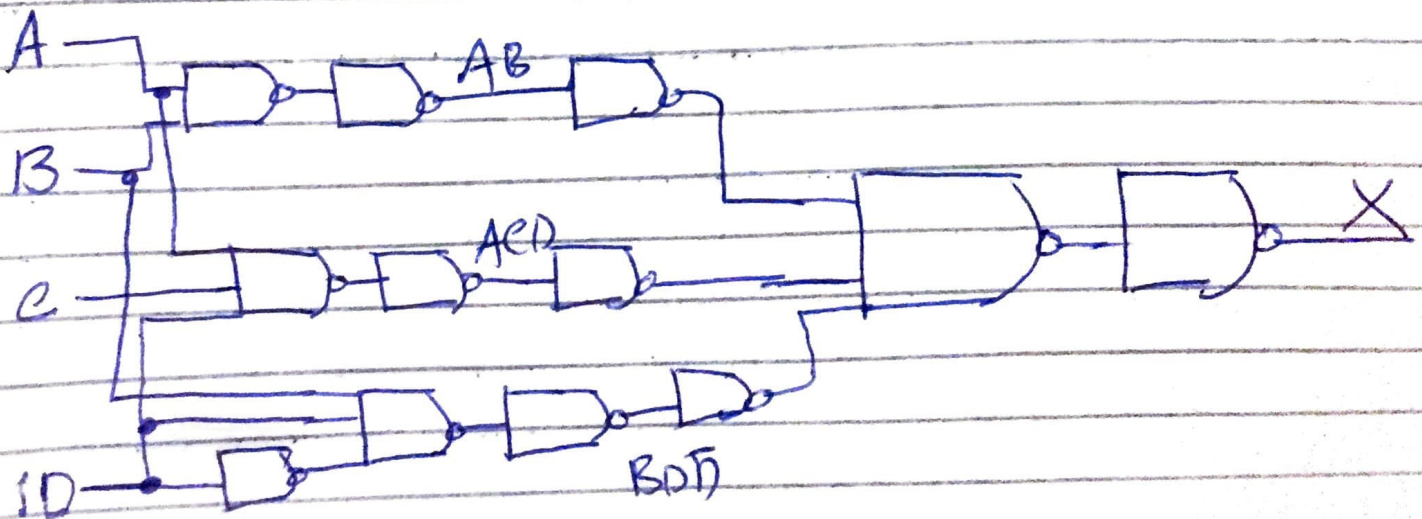

$$X = \overline{AB + ACD + DBD} \quad \text{As}$$

Ans Q 14:

$$X = (AB + CD)(EF + GH)$$

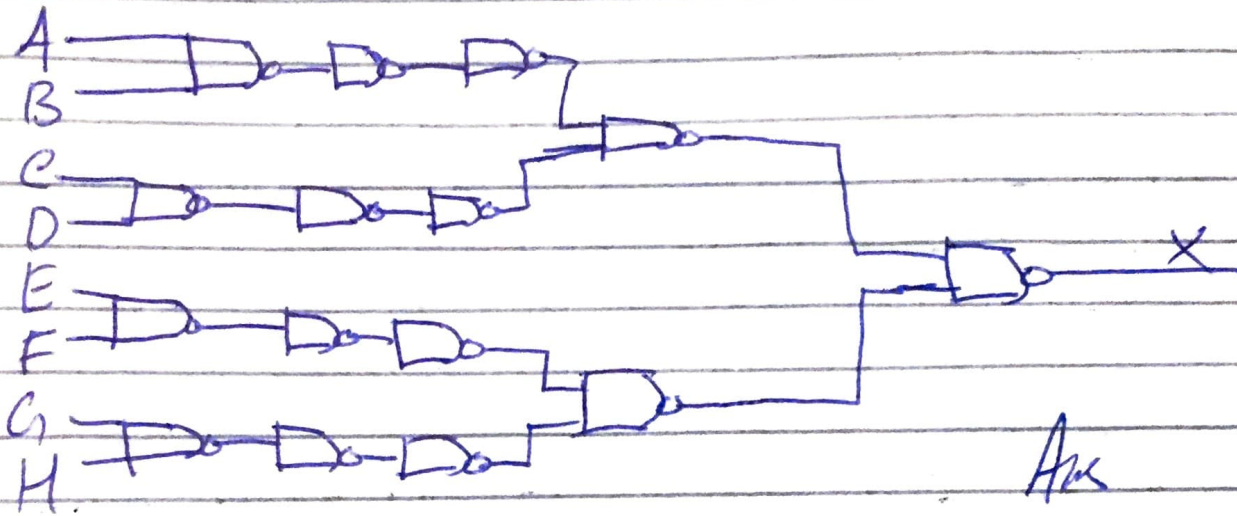

Ans

Ans Q 15:

$$X = AB + A\bar{C}D + D\bar{B}\bar{D}$$

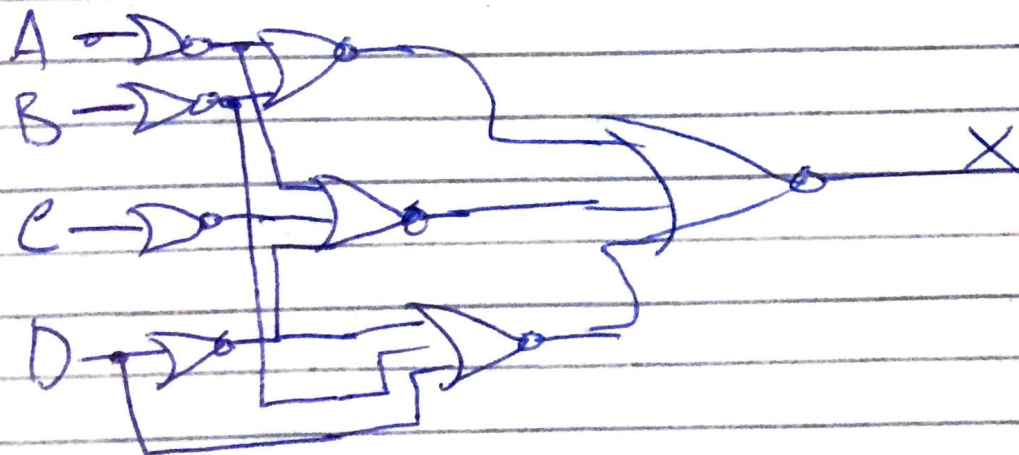

Ans. Q 16:

$$X = (AB + CD)(EF + GH)$$

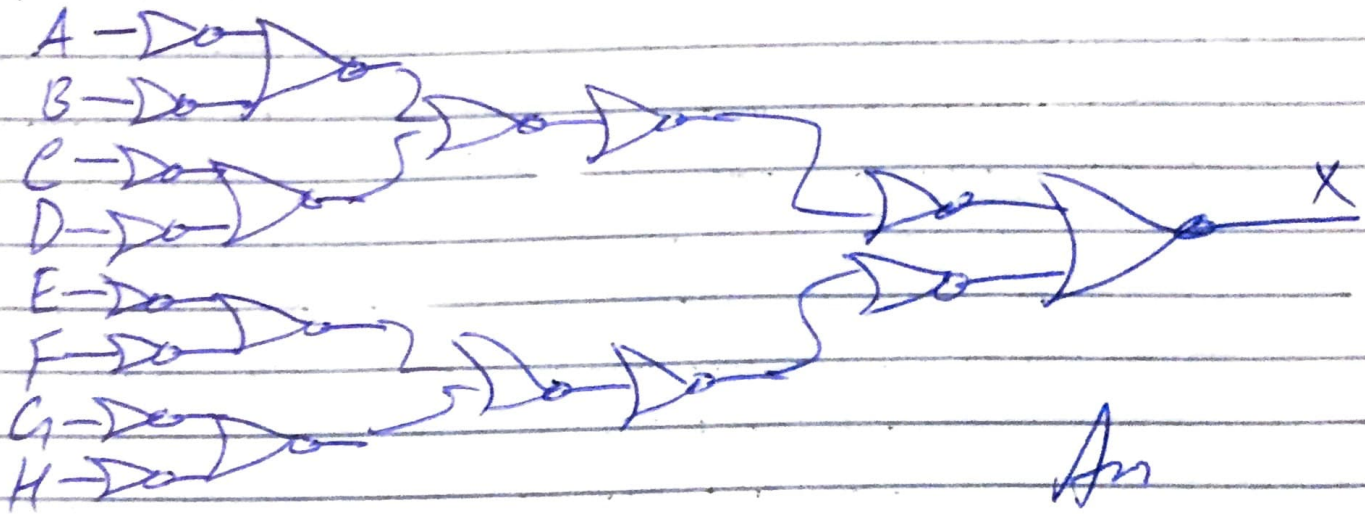

Ans. Q 17:

$$X = AB[C(\overline{DE} + \overline{AB}) + BCE]$$

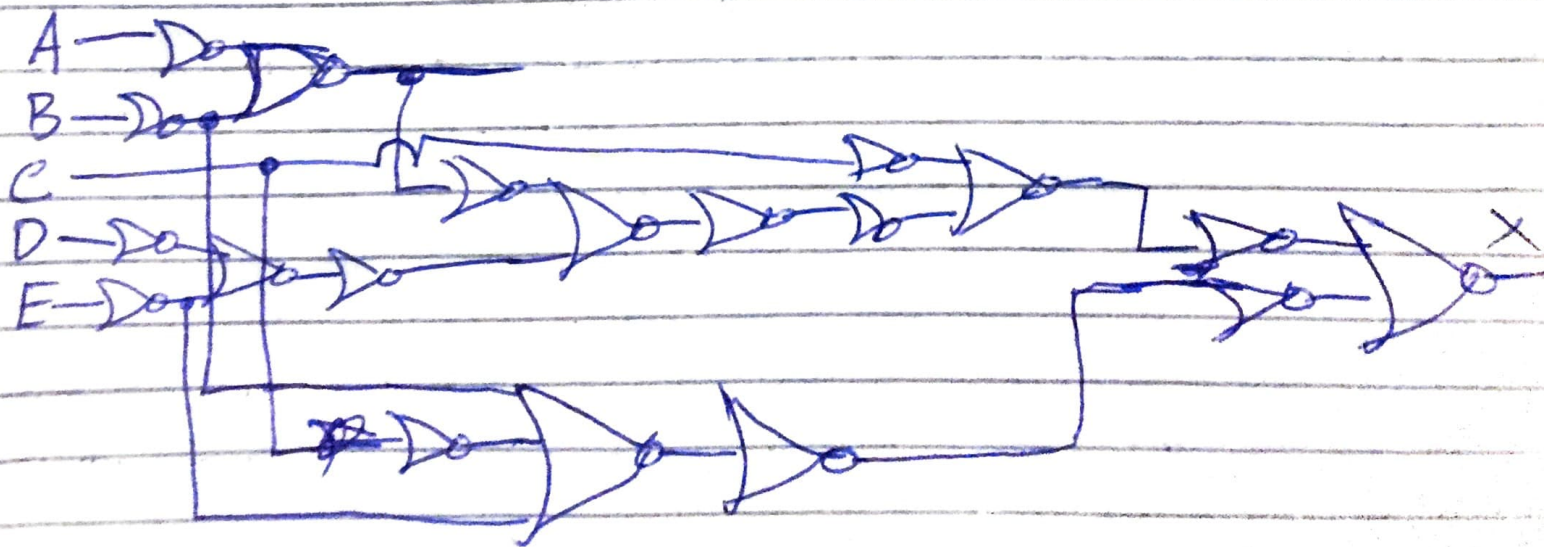

Ans Q 18:

$$X = AB[C(\overline{DE} + \overline{AB}) + B\overline{C}E]$$

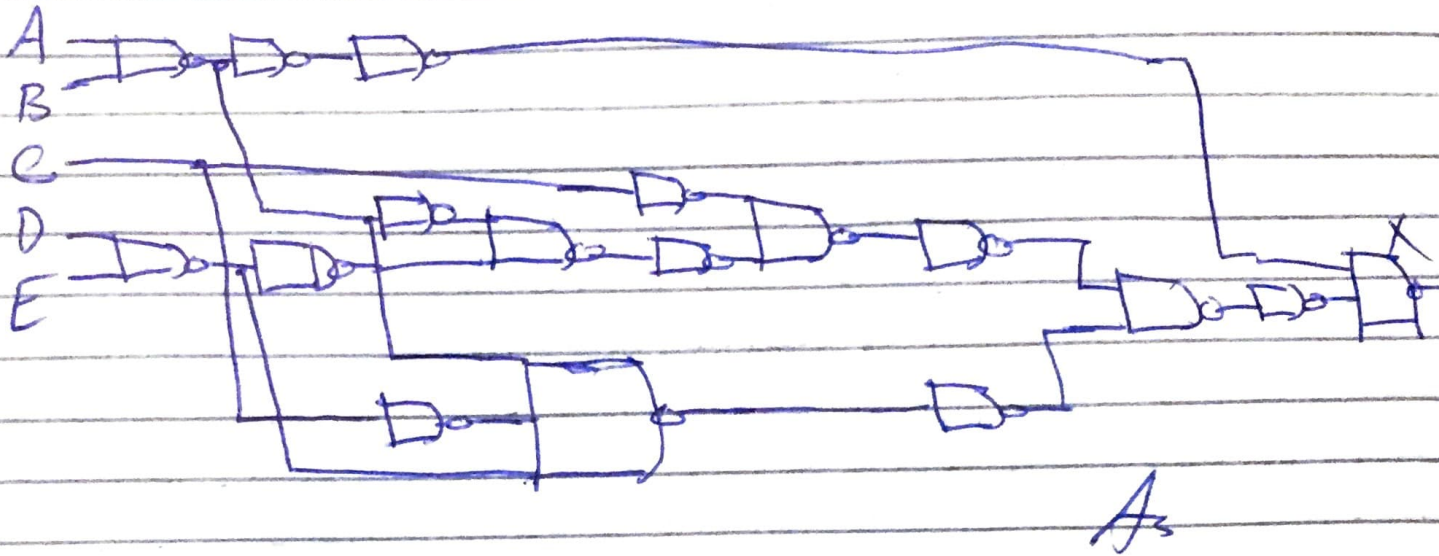

Ans Q 19:

$$X = ABC(D+E+F) + AC(E+D+E)$$

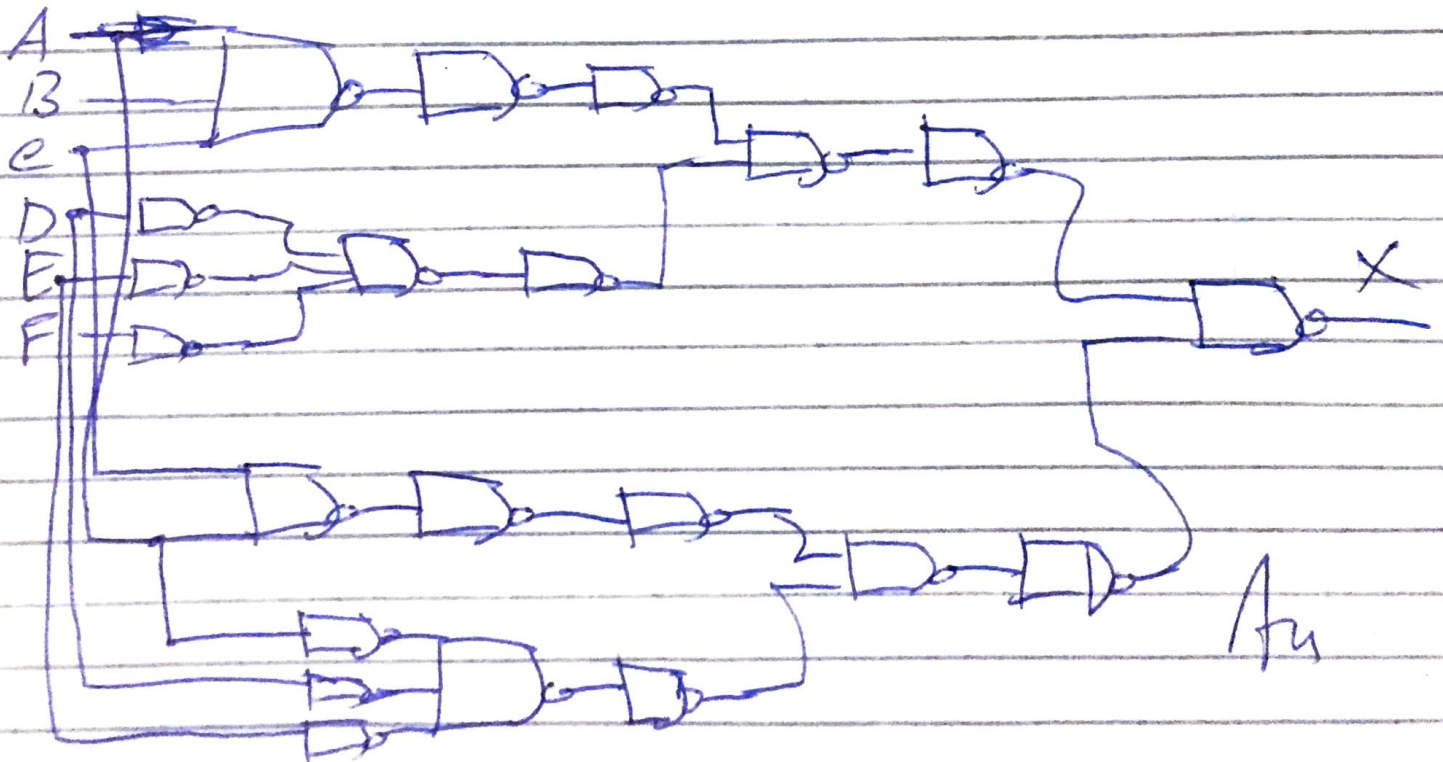

Ans Q 209

$$X = B(CDE + EFG)(\overline{AB} + C)$$

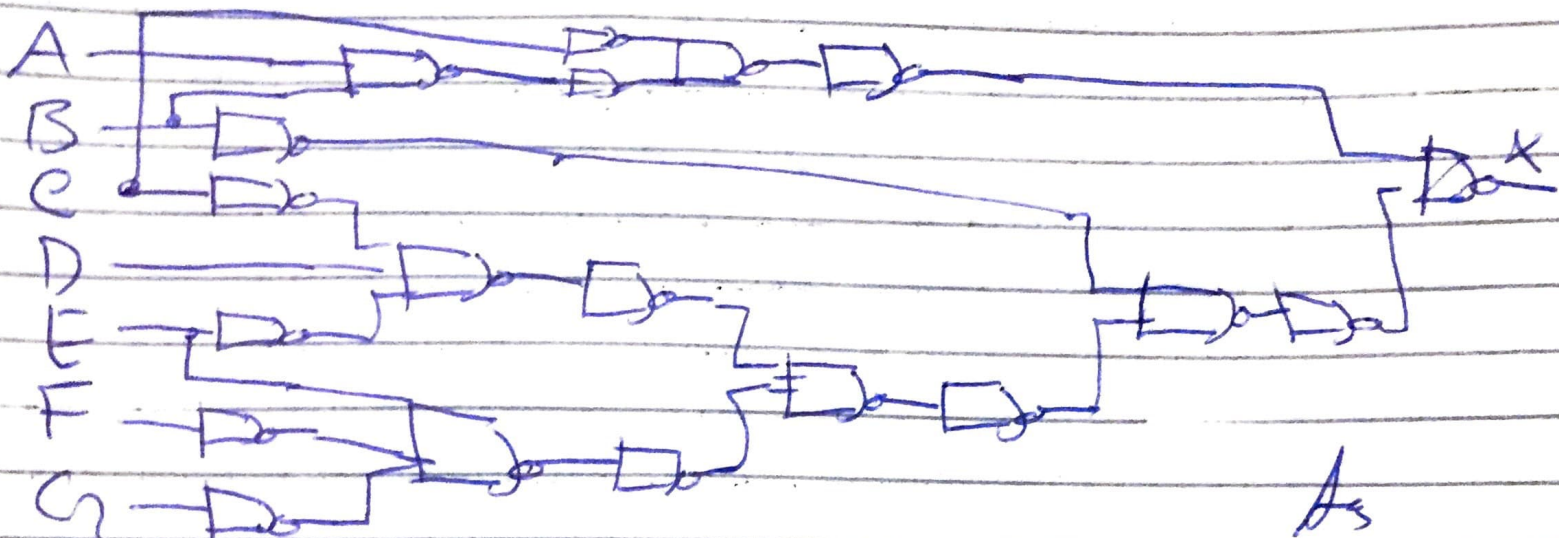

Ans Q 215

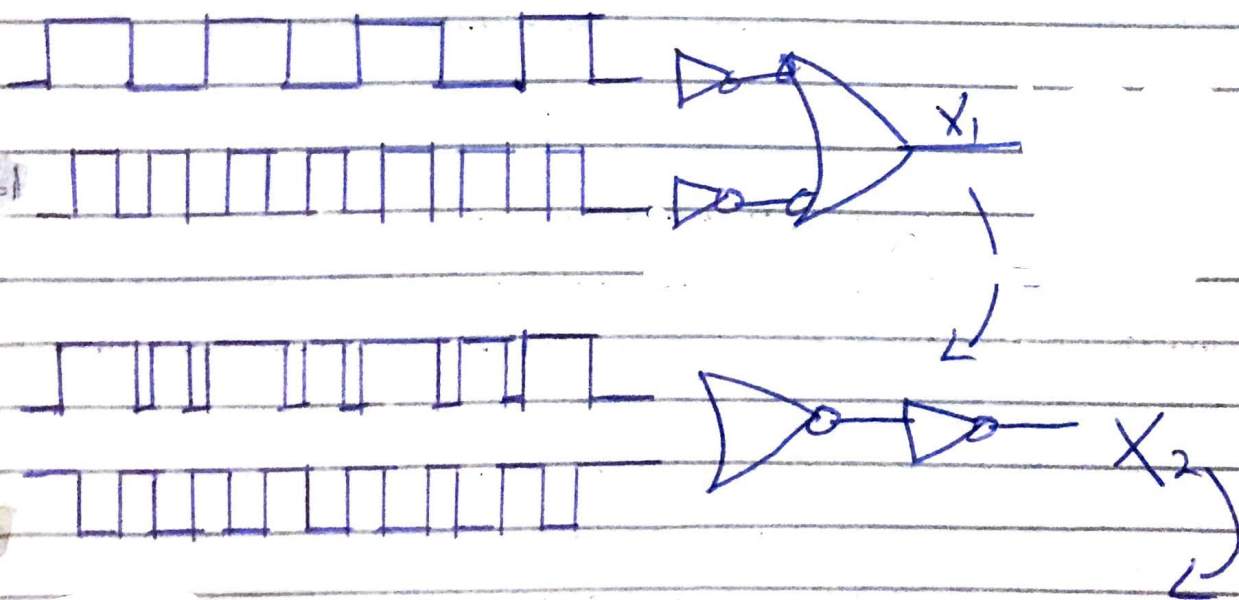

Ans

Ans Q 22:

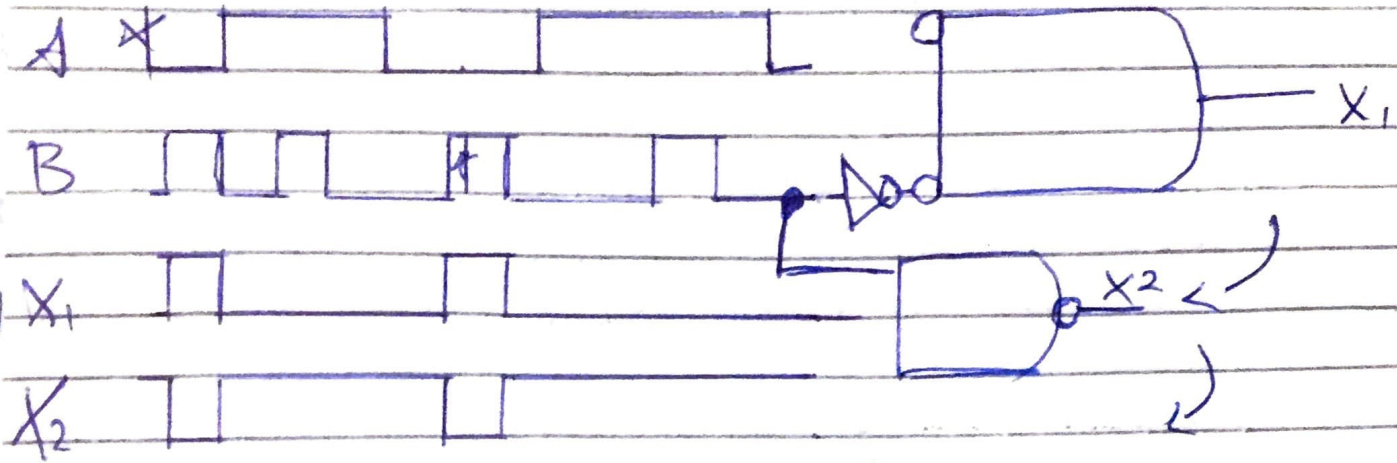

Ans

Ans Q 23:

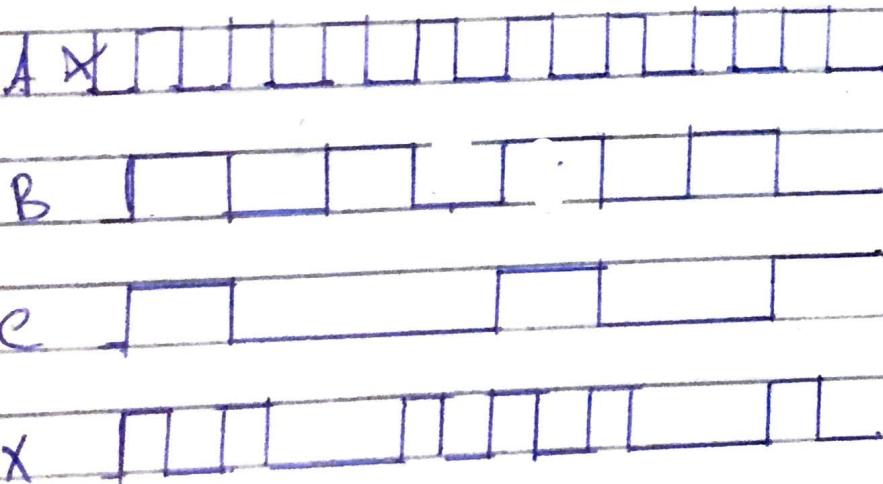

Ans Q 24:

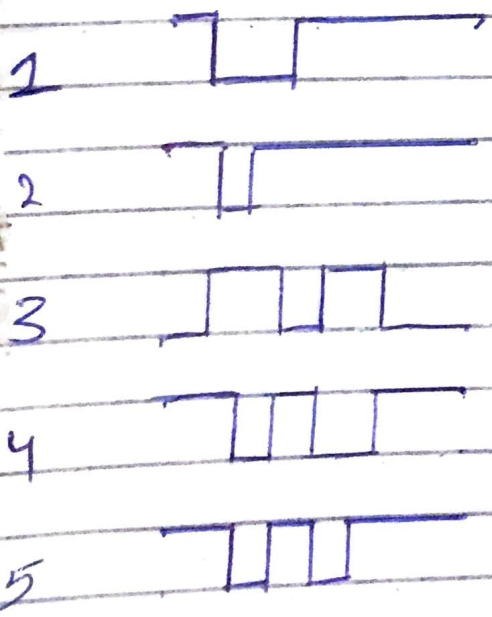
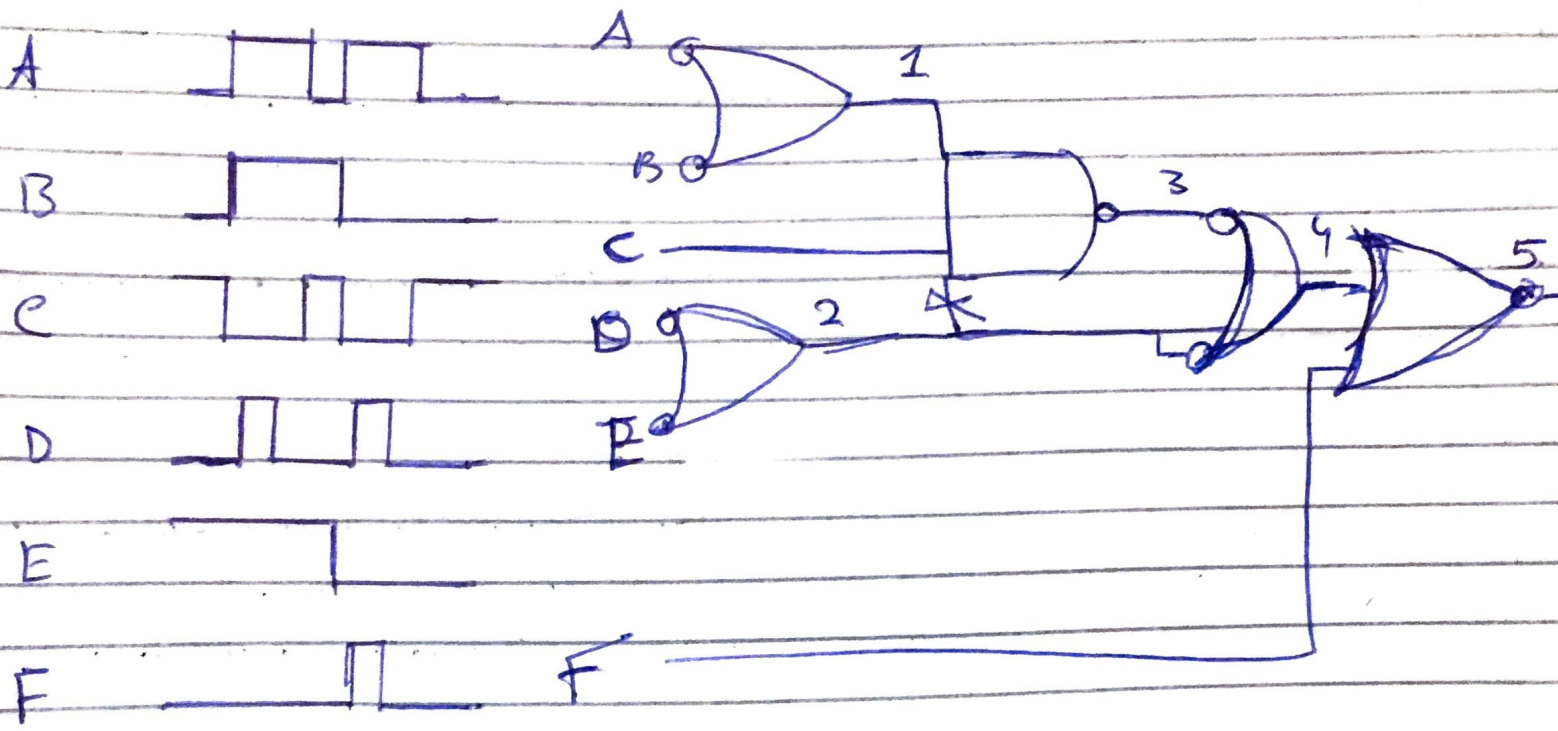

[Handwritten signature]