

**Solution Manual for**

**B.P. Lathi**

**LINEAR SYSTEMS AND SIGNALS**

---

---

# Chapter 1

---

1.1-1 From Newton's law

$$f(t) = M \frac{dv}{dt}$$

and

$$v(t) = \frac{1}{M} \int_{-\infty}^t f(\tau) d\tau = \frac{1}{M} \int_{-\infty}^0 f(\tau) d\tau + \frac{1}{M} \int_0^t f(\tau) d\tau = v(0) + \frac{1}{M} \int_0^t f(\tau) d\tau$$

1.1-2 If  $f(t)$  and  $y(t)$  are the input and output, respectively, of an ideal integrator, then

$$\dot{y}(t) = f(t)$$

and

$$y(t) = \int_{-\infty}^t f(\tau) d\tau = \int_{-\infty}^0 f(\tau) d\tau + \int_0^t f(\tau) d\tau = \underbrace{y(0)}_{\text{zero-input}} + \underbrace{\int_0^t f(\tau) d\tau}_{\text{zero-state}}$$

1.2-1 Only (b) and (f) are linear. All the remaining are nonlinear. This can be verified by using the procedure discussed in Example 1.1.

1.3-1 The loop equation for the circuit is

$$3y_1(t) + Dy_1(t) = f(t) \quad \text{or} \quad (D + 3)y_1(t) = f(t) \quad (1)$$

Also

$$Dy_1(t) = y_2(t) \implies y_1(t) = \frac{1}{D}y_2(t) \quad (2)$$

Substitution of (2) in (1) yields

$$\frac{(D + 3)}{D}y_2(t) = f(t) \quad \text{or} \quad (D + 3)y_2(t) = Df(t) \quad (3)$$

1.3-2 The currents in the resistor, capacitor and inductor are  $2y_2(t)$ ,  $Dy_2(t)$  and  $(2/D)y_2(t)$ , respectively. Therefore

$$(D + 2 + \frac{2}{D})y_2(t) = f(t)$$

or

$$(D^2 + 2D + 2)y_2(t) = Df(t) \quad (1)$$

Also

$$y_1(t) = Dy_2(t) \quad \text{or} \quad y_2(t) = \frac{1}{D}y_1(t) \quad (2)$$

Substituting of (2) in (1) yields

$$\frac{D^2 + 2D + 2}{D}y_1(t) = Df(t)$$

or

$$(D^2 + 2D + 2)y_1(t) = D^2f(t) \quad (3)$$

1.3-3 The freebody diagram for the mass  $M$  is shown in Fig. S1.3-3. From this diagram it follows that

$$M\ddot{y} = B(\dot{x} - \dot{y}) + K(x - y)$$

or

$$(MD^2 + BD + K)y(t) = (BD + K)x(t)$$

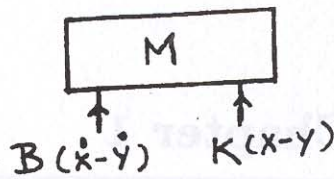

Fig. S1.3-3

1.3-4

$$[q_i(t) - q_0(t)]\Delta t = A\Delta h$$

or

$$\dot{h}(t) = \frac{1}{A}[q_i(t) - q_0(t)] \quad (1)$$

But

$$q_0(t) = Rh(t) \quad (2)$$

Differentiation of (2) yields

$$\dot{q}_0(t) = R\dot{h}(t) = \frac{R}{A}[q_i(t) - q_0(t)]$$

and

$$\left(D + \frac{R}{A}\right)q_0(t) = \frac{R}{A}q_i(t)$$

or

$$(D + a)q_0(t) = aq_i(t) \quad a = \frac{R}{A} \quad (3)$$

and

$$q_0(t) = \frac{a}{D + a}q_i(t)$$

substituting this in (1) yields

$$\dot{h}(t) = \frac{1}{A}\left(1 - \frac{a}{D + a}\right)q_i(t) = \frac{D}{A(D + a)}q_i(t)$$

or

$$(D + a)h(t) = \frac{1}{A}q_i(t) \quad (4)$$

1.3-5 The loop equation for the field coil is

$$(DL_f + R_f)i_f(t) = f(t) \quad (1)$$

If  $T(t)$  is the torque generated, then

$$T(t) = K_f i_f(t) = (JD^2 + BD)\theta(t) \quad (2)$$

substituting (1) in (2) yields

$$\frac{K_f}{DL_f + R_f}f(t) = (JD^2 + BD)\theta(t)$$

or

$$(JD^2 + BD)(DL_f + R_f)\theta(t) = K_f f(t) \quad (3)$$

1.4-1 The loop equation for the network in Fig. P1.4-1 are:

$$\begin{aligned} \left(5 + \frac{2}{D}\right)y_1(t) - 3y_2(t) &= f(t) \\ -3y_1(t) + (D + 3)y_2(t) &= 0 \end{aligned} \Rightarrow \begin{bmatrix} 5 + \frac{2}{D} & -3 \\ -3 & D + 3 \end{bmatrix} \begin{bmatrix} y_1(t) \\ y_2(t) \end{bmatrix} = \begin{bmatrix} f(t) \\ 0 \end{bmatrix}$$

Application of the Cramer's rule yields

$$y_1(t) = \frac{D(D + 3)}{5D^2 + 8D + 6}f(t) \quad \text{and} \quad y_2(t) = \frac{3D}{5D^2 + 8D + 6}f(t)$$

or

$$(5D^2 + 8D + 6)y_1(t) = D(D + 3)f(t) \quad \text{and} \quad (5D^2 + 8D + 6)y_2(t) = 3Df(t)$$



1.4-2 The loop equations for this network are

$$\begin{aligned} \left(9 + \frac{18}{D}\right) y_1 - \frac{18}{D} y_2 &= f \\ -\frac{18}{D} y_1 + \left(\frac{D}{2} + 1 + \frac{18}{D}\right) y_2 &= 0 \end{aligned} \quad (1)$$

They are expressed in matrix form as

$$\begin{bmatrix} 9 + \frac{18}{D} & -\frac{18}{D} \\ -\frac{18}{D} & \left(\frac{D}{2} + 1 + \frac{18}{D}\right) \end{bmatrix} \begin{bmatrix} y_1(t) \\ y_2(t) \end{bmatrix} = \begin{bmatrix} f(t) \\ 0 \end{bmatrix}$$

Application of the Cramer's rule yields

$$y_1(t) = \frac{D^2 + 2D + 36}{9(D^2 + 4D + 40)} f(t)$$

$$y_2(t) = \frac{4}{D^2 + 4D + 40} f(t)$$

or

$$(D^2 + 4D + 40)y_1(t) = \frac{1}{9}(D^2 + 2D + 36)f(t) \quad \text{and} \quad (D^2 + 4D + 40)y_2(t) = 4f(t)$$

1.5-1

$$(D + 3)y_1(t) - (D + 1)y_2(t) = f(t)$$

$$-(D + 1)y_1(t) + \left(D + 2 + \frac{1}{D}\right)y_2(t) = 0$$

or

$$\begin{bmatrix} D + 3 & -(D + 1) \\ -(D + 1) & \left(D + 2 + \frac{1}{D}\right) \end{bmatrix} \begin{bmatrix} y_1(t) \\ y_2(t) \end{bmatrix} = \begin{bmatrix} f(t) \\ 0 \end{bmatrix}$$

Cramer's rule yields

$$y_1(t) = \frac{D^2 + 2D + 1}{3(D^2 + 2D + 1)} f(t) \quad \text{and} \quad y_2(t) = \frac{D(D + 1)}{3(D^2 + 2D + 1)} f(t)$$

or

$$(D^2 + 2D + 1)y_1(t) = \frac{1}{3}(D^2 + 2D + 1)f(t) \quad \text{and} \quad (D^2 + 2D + 1)y_2(t) = \frac{1}{3}(D^2 + D)f(t)$$

1.6-1 The capacitor current  $C\dot{x}_3 = \frac{1}{2}\dot{x}_3$  is  $x_1 - x_2$ . Therefore

$$\dot{x}_3 = 2x_1 - 2x_2 \quad (1)$$

The two loop equations are

$$2x_1 + \dot{x}_1 + x_3 = f \implies \dot{x}_1 = -2x_1 - x_3 + f \quad (2)$$

$$-x_3 + \frac{1}{3}\dot{x}_2 + x_2 = 0 \implies \dot{x}_2 = -3x_2 + 3x_3 \quad (3)$$

Equations (1), (2) and (3) are the state equations

For the  $2\Omega$  resistor: current is  $x_1$ , voltage is  $2x_1$ .

For the  $1\text{H}$  inductor: current is  $x_1$ , voltage is  $\dot{x}_1 = f(t) - 2x_1 - x_3$ .

For the capacitor: current is  $x_1 - x_2$ , voltage is  $x_3$ .

For the  $\frac{1}{3}\text{H}$  inductor: current is  $x_2$ , voltage is  $\frac{1}{3}\dot{x}_2 = -x_2 + x_3$ .

For the  $1\Omega$  resistor: current is  $x_2$  and voltage is  $x_2$ .

At the instant  $t$ ,  $x_1 = 5$ ,  $x_2 = 1$ ,  $x_3 = 2$  and  $f = 10$ . Substituting these values in the above results yields

$2\Omega$  resistor: current 5A, voltage 10A.

$1\text{H}$  capacitor: current 5A, voltage  $10 - 10 - 2 = -2\text{V}$ .

The capacitor: current  $5 - 1 = 4\text{A}$ , voltage  $2\text{V}$ .

The  $\frac{1}{3}\text{H}$  inductor: current 1A, voltage  $-1 + 2 = 1\text{V}$ .

The  $1\Omega$  resistor: current 1A, voltage 1V.

# Chapter 2

- 2.2-1 The characteristic polynomial is  $\lambda^2 + 5\lambda + 6$ . The characteristic equation is  $\lambda^2 + 5\lambda + 6 = 0$ . Also  $\lambda^2 + 5\lambda + 6 = (\lambda + 2)(\lambda + 3)$ . Therefore the characteristic roots are  $\lambda_1 = -2$  and  $\lambda_2 = -3$ . The characteristic modes are  $e^{-2t}$  and  $e^{-3t}$ . Therefore

$$y_0(t) = c_1 e^{-2t} + c_2 e^{-3t}$$

and

$$\dot{y}_0(t) = -2c_1 e^{-2t} - 3c_2 e^{-3t}$$

Setting  $t = 0$ , and substituting initial conditions  $y_0(0) = 2$ ,  $\dot{y}_0(0) = -1$  in this equation yields

$$\left. \begin{array}{l} c_1 + c_2 = 2 \\ -2c_1 - 3c_2 = -1 \end{array} \right\} \Rightarrow \begin{array}{l} c_1 = 5 \\ c_2 = -3 \end{array}$$

Therefore

$$y_0(t) = 5e^{-2t} - 3e^{-3t}$$

- 2.2-2 The characteristic polynomial is  $\lambda^2 + 4\lambda + 4$ . The characteristic equation is  $\lambda^2 + 4\lambda + 4 = 0$ . Also  $\lambda^2 + 4\lambda + 4 = (\lambda + 2)^2$ , so that the characteristic roots are  $-2$  and  $-2$  (repeated twice). The characteristic modes are  $e^{-2t}$  and  $te^{-2t}$ . Therefore

$$y_0(t) = c_1 e^{-2t} + c_2 t e^{-2t}$$

and

$$\dot{y}_0(t) = -2c_1 e^{-2t} - 2c_2 t e^{-2t} + c_2 e^{-2t}$$

Setting  $t = 0$  and substituting initial conditions yields

$$\left. \begin{array}{l} 3 = c_1 \\ -4 = -2c_1 + c_2 \end{array} \right\} \Rightarrow \begin{array}{l} c_1 = 3 \\ c_2 = 2 \end{array}$$

Therefore

$$y_0(t) = (3 + 2t)e^{-2t}$$

- 2.2-3 The characteristic polynomial is  $\lambda(\lambda + 1) = \lambda^2 + \lambda$ . The characteristic equation is  $\lambda(\lambda + 1) = 0$ . The characteristic roots are  $0$  and  $-1$ . The characteristic modes are  $1$  and  $e^{-t}$ . Therefore

$$y_0(t) = c_1 + c_2 e^{-t}$$

and

$$\dot{y}_0(t) = -c_2 e^{-t}$$

Setting  $t = 0$ , and substituting initial conditions yields

$$\left. \begin{array}{l} 1 = c_1 + c_2 \\ 1 = -c_2 \end{array} \right\} \Rightarrow \begin{array}{l} c_1 = 2 \\ c_2 = -1 \end{array}$$

Therefore

$$y_0(t) = 2 - e^{-t}$$

- 2.2-4 The characteristic polynomial is  $\lambda^2 + 9$ . The characteristic equation is  $\lambda^2 + 9 = 0$  or  $(\lambda + j3)(\lambda - j3) = 0$ . The characteristic roots are  $\pm j3$ . The characteristic modes are  $e^{j3t}$  and  $e^{-j3t}$ . Therefore

$$y_0(t) = c \cos(3t + \theta)$$

and

$$\dot{y}_0(t) = -3c \sin(3t + \theta)$$

Setting  $t = 0$ , and substituting initial conditions yields

$$\left. \begin{array}{l} 0 = c \cos \theta \\ 6 = -3c \sin \theta \end{array} \right\} \Rightarrow \left. \begin{array}{l} c \cos \theta = 0 \\ c \sin \theta = -2 \end{array} \right\} \Rightarrow \begin{array}{l} c = 2 \\ \theta = -\pi/2 \end{array}$$

Therefore

$$y_0(t) = 2 \cos(3t - \frac{\pi}{2}) = 2 \sin 3t$$

- 2.2-5 The characteristic polynomial is  $\lambda^2 + 4\lambda + 13$ . The characteristic equation is  $\lambda^2 + 4\lambda + 13 = 0$  or  $(\lambda + 2 - j3)(\lambda + 2 + j3) = 0$ . The characteristic roots are  $-2 \pm j3$ . The characteristic modes are  $c_1 e^{(-2+j3)t}$  and  $c_2 e^{(-2-j3)t}$ . Therefore

$$y_0(t) = c e^{-2t} \cos(3t + \theta)$$

and

$$\dot{y}_0(t) = -2c e^{-2t} \cos(3t + \theta) - 3c e^{-2t} \sin(3t + \theta)$$

Setting  $t = 0$ , and substituting initial conditions yields

$$\left. \begin{aligned} 5 &= c \cos \theta \\ 15.98 &= -2c \cos \theta - 3c \sin \theta \end{aligned} \right\} \Rightarrow \left. \begin{aligned} c \cos \theta &= 5 \\ c \sin \theta &= -8.66 \end{aligned} \right\} \Rightarrow \begin{aligned} c &= 10 \\ \theta &= -\pi/3 \end{aligned}$$

Therefore

$$y_0(t) = 10 e^{-2t} \cos(3t - \frac{\pi}{3})$$

- 2.2-6 The characteristic polynomial is  $\lambda^2(\lambda + 1)$  or  $\lambda^3 + \lambda^2$ . The characteristic equation is  $\lambda^2(\lambda + 1) = 0$ . The characteristic roots are 0, 0 and  $-1$  (0 is repeated twice). Therefore

$$y_0(t) = c_1 + c_2 t + c_3 e^{-t}$$

and

$$\begin{aligned} \dot{y}_0(t) &= c_2 - c_3 e^{-t} \\ \ddot{y}_0(t) &= c_3 e^{-t} \end{aligned}$$

Setting  $t = 0$ , and substituting initial conditions yields

$$\left. \begin{aligned} 4 &= c_1 + c_3 \\ 3 &= c_2 - c_3 \\ -1 &= c_3 \end{aligned} \right\} \Rightarrow \begin{aligned} c_1 &= 5 \\ c_2 &= 2 \\ c_3 &= -1 \end{aligned}$$

Therefore

$$y_0(t) = 5 + 2t - e^{-t}$$

- 2.2-7 The characteristic polynomial is  $(\lambda + 1)(\lambda^2 + 5\lambda + 6)$ . The characteristic equation is  $(\lambda + 1)(\lambda^2 + 5\lambda + 6) = 0$  or  $(\lambda + 1)(\lambda + 2)(\lambda + 3) = 0$ . The characteristic roots are  $-1, -2$  and  $-3$ . The characteristic modes are  $e^{-t}, e^{-2t}$  and  $e^{-3t}$ . Therefore

$$y_0(t) = c_1 e^{-t} + c_2 e^{-2t} + c_3 e^{-3t}$$

and

$$\begin{aligned} \dot{y}_0(t) &= -c_1 e^{-t} - 2c_2 e^{-2t} - 3c_3 e^{-3t} \\ \ddot{y}_0(t) &= c_1 e^{-t} + 4c_2 e^{-2t} + 9c_3 e^{-3t} \end{aligned}$$

Setting  $t = 0$ , and substituting initial conditions yields

$$\left. \begin{aligned} 2 &= c_1 + c_2 + c_3 \\ -1 &= -c_1 - 2c_2 - 3c_3 \\ 5 &= c_1 + 4c_2 + 9c_3 \end{aligned} \right\} \Rightarrow \begin{aligned} c_1 &= 6 \\ c_2 &= -7 \\ c_3 &= 3 \end{aligned}$$

Therefore

$$y_0(t) = 6e^{-t} - 7e^{-2t} + 3e^{-3t}$$

- 2.3-1 Using the fact that  $f(x)\delta(x) = f(0)\delta(x)$ , we have

(a) 0 (b)  $\frac{2}{9}\delta(\omega)$  (c)  $\frac{1}{2}\delta(t)$  (d)  $-\frac{1}{2}\delta(t-1)$  (e)  $\frac{1}{2-j3}\delta(\omega+3)$  (f)  $k\delta(\omega)$  (use L' Hôpital's rule)

- 2.3-2 In these problems remember that impulse  $\delta(x)$  is located at  $x = 0$ . Thus, an impulse  $\delta(t - \tau)$  is located at  $\tau = t$ , and so on.

(a) The impulse is located at  $\tau = t$  and  $f(\tau)$  at  $\tau = t$  is  $f(t)$ . Therefore

$$\int_{-\infty}^{\infty} f(\tau)\delta(t - \tau) d\tau = f(t)$$

(b) The impulse  $\delta(\tau)$  is at  $\tau = 0$  and  $f(t - \tau)$  at  $\tau = 0$  is  $f(t)$ . Therefore



$$\int_{-\infty}^{\infty} \delta(\tau) f(t - \tau) d\tau = f(t)$$

Using similar arguments, we obtain

(c) 1 (d) 0 (e)  $e^3$  (f) 5 (g)  $f(-1)$  (h)  $-e^2$

2.3-3 Changing the variable  $t$  to  $-x$ , we obtain

$$\int_{-\infty}^{\infty} \phi(t) \delta(-t) dt = - \int_{\infty}^{-\infty} \phi(-x) \delta(x) dx = \int_{-\infty}^{\infty} \phi(-x) \delta(x) dx = \phi(0)$$

This shows that

$$\int_{-\infty}^{\infty} \phi(t) \delta(t) dt = \int_{-\infty}^{\infty} \phi(t) \delta(-t) dt = \phi(0)$$

Therefore

$$\delta(t) = \delta(-t)$$

2.3-4 Letting  $at = x$ , we obtain (for  $a > 0$ )

$$\int_{-\infty}^{\infty} \phi(t) \delta(at) dt = \frac{1}{a} \int_{-\infty}^{\infty} \phi\left(\frac{x}{a}\right) \delta(x) dx = \frac{1}{a} \phi(0)$$

Similarly for  $a < 0$ , we show that this integral is  $-\frac{1}{|a|} \phi(0)$ . Therefore

$$\int_{-\infty}^{\infty} \phi(t) \delta(at) dt = \frac{1}{|a|} \phi(0) = \frac{1}{|a|} \int_{-\infty}^{\infty} \phi(t) \delta(t) dt$$

Therefore

$$\delta(at) = \frac{1}{|a|} \delta(t)$$

2.3-5 (a)

$$\begin{aligned} \int_{-\infty}^{\infty} \delta(t) \phi(t) dt &= \phi(t) \delta(t) \Big|_{-\infty}^{\infty} - \int_{-\infty}^{\infty} \dot{\phi}(t) \delta(t) dt \\ &= 0 - \int \dot{\phi}(t) \delta(t) dt = -\dot{\phi}(0) \end{aligned}$$

2.3-6 The characteristic equation is  $\lambda^2 + 4\lambda + 3 = (\lambda + 1)(\lambda + 3) = 0$ . The characteristic modes are  $e^{-t}$  and  $e^{-3t}$ . Therefore

$$\begin{aligned} y_0(t) &= c_1 e^{-t} + c_2 e^{-3t} \\ \dot{y}_0(t) &= -c_1 e^{-t} - 3c_2 e^{-3t} \end{aligned}$$

Setting  $t = 0$ , and substituting  $y(0) = 0$ ,  $\dot{y}(0) = 1$ , we obtain

$$\left. \begin{aligned} 0 &= c_1 + c_2 \\ 1 &= -c_1 - 3c_2 \end{aligned} \right\} \Rightarrow \begin{aligned} c_1 &= \frac{1}{2} \\ c_2 &= -\frac{1}{2} \end{aligned}$$

Therefore

$$y_0(t) = \frac{1}{2}(e^{-t} - e^{-3t})$$

$$h(t) = [P(D)y_0(t)]u(t) = [(D + 5)y_0(t)]u(t) = [\dot{y}_0(t) + 5y_0(t)]u(t) = (2e^{-t} - e^{-3t})u(t)$$

2.3-7 The characteristic equation is  $\lambda^2 + 5\lambda + 6 = (\lambda + 2)(\lambda + 3) = 0$ . and

$$\begin{aligned} y_0(t) &= c_1 e^{-2t} + c_2 e^{-3t} \\ \dot{y}_0(t) &= -2c_1 e^{-2t} - 3c_2 e^{-3t} \end{aligned}$$

Setting  $t = 0$ , and substituting  $y(0) = 0$ ,  $\dot{y}(0) = 1$ , we obtain

$$\left. \begin{aligned} 0 &= c_1 + c_2 \\ 1 &= -2c_1 - 3c_2 \end{aligned} \right\} \Rightarrow \begin{aligned} c_1 &= 1 \\ c_2 &= -1 \end{aligned}$$

Therefore

$$y_0(t) = e^{-2t} - e^{-3t}$$

and

$$[P(D)y_0(t)]u(t) = [\ddot{y}_0(t) + 7\dot{y}_0(t) + 11y_0(t)]u(t) = (e^{-2t} + e^{-3t})u(t)$$

Hence

$$h(t) = b_n \delta(t) + [P(D)y_0(t)]u(t) = \delta(t) + (e^{-2t} + e^{-3t})u(t)$$

2.3-8 The characteristic equation is  $\lambda + 1 = 0$  and

$$y_0(t) = ce^{-t}$$

In this case the initial condition is  $y_0^{n-1}(0) = y_0(0) = 1$ . Setting  $t = 0$ , and using  $y_0(0) = 1$ , we obtain  $c = 1$ , and

$$y_0(t) = e^{-t}$$

$$P(D)y_0(t) = [-\dot{y}_0(t) + y_0(t)]u(t) = 2e^{-t}u(t)$$

Hence

$$h(t) = b_n \delta(t) + [P(D)y_0(t)]u(t) = -\delta(t) + 2e^{-t}u(t)$$

2.3-9 (a) The characteristic equation is  $\lambda^2 + 5\lambda + 6 = (\lambda + 2)(\lambda + 3) = 0$ . Therefore

$$\begin{aligned} y_0(t) &= c_1 e^{-2t} + c_2 e^{-3t} \\ \dot{y}_0(t) &= -2c_1 e^{-2t} - 3c_2 e^{-3t} \end{aligned}$$

Setting  $t = 0$ , and substituting  $y_0(0) = 0$ ,  $\dot{y}_0(0) = 1$ , we obtain

$$\left. \begin{aligned} 0 &= c_1 + c_2 \\ 1 &= -2c_1 - 3c_2 \end{aligned} \right\} \Rightarrow \begin{aligned} c_1 &= 1 \\ c_2 &= -1 \end{aligned}$$

Therefore

$$\begin{aligned} y_0(t) &= e^{-2t} - e^{-3t} \\ \dot{y}_0(t) &= -2e^{-2t} + 3e^{-3t} \end{aligned}$$

and

$$h(t) = [P(D)y_0(t)]u(t) = [\dot{y}_0(t) + 2y_0(t)]u(t) = e^{-3t}u(t)$$

(b) The characteristic equation is  $\lambda + 3 = 0$ . Therefore

$$y_0(t) = ce^{-3t}$$

Setting  $t = 0$ , and substituting  $\dot{y}_0(0) = 1$  [see Eq. (2.42)], we obtain  $c = 1$ , and

$$h(t) = [P(D)y_0(t)]u(t) = y_0(t)u(t) = e^{-3t}u(t)$$

2.3-10 The characteristic equation is  $\lambda^2 + 6\lambda + 9 = (\lambda + 3)^2 = 0$ . Therefore

$$\begin{aligned} y_0(t) &= (c_1 + c_2 t)e^{-3t} \\ \dot{y}_0(t) &= [-3(c_1 + c_2 t) + c_2]e^{-3t} \end{aligned}$$

Setting  $t = 0$ , and substituting  $y_0(0) = 1$ ,  $\dot{y}_0(0) = 1$ , we obtain

$$\left. \begin{aligned} 0 &= c_1 \\ 1 &= -3c_1 + c_2 \end{aligned} \right\} \Rightarrow \begin{aligned} c_1 &= 0 \\ c_2 &= 1 \end{aligned}$$

and

$$y_0(t) = te^{-3t}$$



Hence

$$h(t) = [P(D)y_0(t)]u(t) = [2\dot{y}_0(t) + 9y_0(t)]u(t) = (2 + 3t)e^{-3t}u(t)$$

2.3-11 The characteristic equation is  $\lambda^2 + 10\lambda + 34 = (\lambda + 5 - j3)(\lambda + 5 + j3) = 0$ . Therefore

$$\begin{aligned} y_0(t) &= ce^{-5t} \cos(3t + \theta) \\ \dot{y}_0(t) &= -5ce^{-5t} \cos(3t + \theta) - 3ce^{-5t} \sin(3t + \theta) \end{aligned}$$

Setting  $t = 0$ , and substituting  $y_0(0) = 0$ ,  $\dot{y}_0(0) = 1$ , we obtain

$$\left. \begin{aligned} 0 &= c \cos \theta \\ 1 &= -5c \cos \theta - 3c \sin \theta \end{aligned} \right\} \Rightarrow \left. \begin{aligned} c \cos \theta &= 0 \\ c \sin \theta &= -\frac{1}{3} \end{aligned} \right\} \Rightarrow \begin{aligned} c &= \frac{1}{3} \\ \theta &= -\frac{\pi}{2} \end{aligned}$$

Therefore

$$y_0(t) = \frac{1}{3}e^{-5t} \cos(3t - \frac{\pi}{2}) = \frac{1}{3}e^{-5t} \sin 3t$$

and

$$h(t) = [P(D)y_0(t)]u(t) = [\dot{y}_0(t) + 9y_0(t)]u(t) = (\cos 3t + \frac{4}{3} \sin 3t)e^{-5t}u(t) = \frac{5}{3}e^{-5t} \cos(3t - 53.13^\circ)u(t)$$

2.3-12 The characteristic equation is  $(\lambda + 1)(\lambda + 2)(\lambda + 3) = 0$ . Therefore

$$\begin{aligned} y_0(t) &= c_1 e^{-t} + c_2 e^{-2t} + c_3 e^{-3t} \\ \dot{y}_0(t) &= -c_1 e^{-t} - 2c_2 e^{-2t} - 3c_3 e^{-3t} \\ \ddot{y}_0(t) &= c_1 e^{-t} + 4c_2 e^{-2t} + 9c_3 e^{-3t} \end{aligned}$$

Setting  $t = 0$ , and substituting  $y_0(0) = \dot{y}_0(0) = 0$ ,  $\ddot{y}_0(0) = 1$ , we obtain

$$\left. \begin{aligned} 0 &= c_1 + c_2 + c_3 \\ 0 &= -c_1 - 2c_2 - 3c_3 \\ 1 &= c_1 + 4c_2 + 9c_3 \end{aligned} \right\} \Rightarrow \begin{aligned} c_1 &= \frac{1}{2} \\ c_2 &= -1 \\ c_3 &= \frac{1}{2} \end{aligned}$$

Therefore

$$y_0(t) = \frac{1}{2}e^{-t} - e^{-2t} + \frac{1}{2}e^{-3t}$$

and

$$h(t) = [P(D)y_0(t)]u(t) = [5\dot{y}_0(t) + 9y_0(t)]u(t) = (2e^{-t} + e^{-2t} - 3e^{-3t})u(t)$$

2.4-1

$$\begin{aligned} e^{-at}u(t) * e^{-bt}u(t) &= \int_0^t e^{-a\tau} e^{-b(t-\tau)} d\tau = e^{-bt} \int_0^t e^{(b-a)\tau} d\tau \\ &= \frac{e^{-bt}}{b-a} e^{(b-a)\tau} \Big|_0^t = \frac{e^{-bt}}{b-a} [e^{(b-a)t} - 1] = \frac{e^{-at} - e^{-bt}}{a-b} \end{aligned}$$

Because both functions are causal, their convolution is zero for  $t < 0$ . Therefore

$$e^{-at}u(t) * e^{-bt}u(t) = \left( \frac{e^{-at} - e^{-bt}}{a-b} \right) u(t)$$

2.4-2 (i)

$$\begin{aligned} u(t) * u(t) &= \int_0^t u(\tau)u(t-\tau) d\tau = \int_0^t d\tau = \tau \Big|_0^t = t \quad \text{for } t \geq 0 \\ &= 0 \quad \text{for } t < 0 \end{aligned}$$

Therefore

$$u(t) * u(t) = tu(t)$$

(ii) Because both functions are causal

$$e^{-at}u(t) * e^{-at}u(t) = \int_0^t e^{-ar}e^{-a(t-r)}dr = e^{-at} \int_0^t dr \\ = te^{-at} \quad t \geq 0$$

and

$$e^{-at}u(t) * e^{-at}u(t) = te^{-at}u(t)$$

(iii) Because both functions are causal

$$tu(t) * u(t) = \int_0^t ru(r)u(r-t)dr$$

The range of integration is  $0 \leq r \leq t$ . Therefore  $r > 0$  and  $r - t > 0$  so that  $u(r) = u(r - t) = 1$  and

$$tu(t) * u(t) = \int_0^t r dr = \frac{t^2}{2} \quad t \geq 0$$

and

$$tu(t) * u(t) = \frac{1}{2}t^2u(t)$$

2.4-3 (i)

$$\sin tu(t) * u(t) = \left( \int_0^t \sin r u(r)u(t-r) dr \right) u(t)$$

Because  $u(r) = u(t - r) = 1$  (see explanation in solution 2.4-2)

$$\sin tu(t) * u(t) = \left( \int_0^t \sin r dr \right) u(t) = (1 - \cos t)u(t)$$

(ii) Similarly

$$\cos tu(t) * u(t) = \left( \int_0^t \cos r dr \right) u(t) = \sin tu(t)$$

2.4-4 In this problem, we use Table 2.1 to find the desired convolution.

$$(a) y(t) = h(t) * f(t) = e^{-t}u(t) * u(t) = (1 - e^{-t})u(t)$$

$$(b) y(t) = h(t) * f(t) = e^{-t}u(t) * e^{-t}u(t) = te^{-t}u(t)$$

$$(c) y(t) = e^{-t}u(t) * e^{-2t}u(t) = (e^{-t} - e^{-2t})u(t)$$

$$(d) y(t) = \sin 3tu(t) * e^{-t}u(t)$$

Here we use pair 12 (Table 2.1) with  $\alpha = 0$ ,  $\beta = 3$ ,  $\theta = -90^\circ$  and  $\lambda = -1$ . This yields

$$\phi = \tan^{-1} \left[ \frac{-3}{-1} \right] = -108.4^\circ$$

and

$$\sin 3tu(t) * e^{-t}u(t) = \frac{(\cos 18.4^\circ)e^{-t} - \cos(3t + 18.4^\circ)}{\sqrt{10}}u(t) \\ = \frac{0.9486e^{-t} - \cos(3t + 18.4^\circ)}{\sqrt{10}}u(t)$$

2.4-5 (a)

$$y(t) = (2e^{-3t} - e^{-2t})u(t) * u(t) = 2e^{-3t}u(t) * u(t) - e^{-2t}u(t) * u(t) \\ = \left[ \frac{2(1 - e^{-3t})}{3} - \frac{1 - e^{-2t}}{2} \right] u(t) \\ = \left( \frac{1}{6} - \frac{2}{3}e^{-3t} + \frac{1}{2}e^{-2t} \right) u(t)$$

(b)

$$\begin{aligned}
(2e^{-3t} - e^{-2t})u(t) * e^{-t}u(t) &= 2e^{-3t}u(t) * e^{-t}u(t) - e^{-2t}u(t) * e^{-t}u(t) \\
&= \left[ \frac{2(e^{-t} - e^{-3t})}{2} - \frac{e^{-t} - e^{-2t}}{1} \right] u(t) \\
&= (e^{-2t} - e^{-3t})u(t)
\end{aligned}$$

(c)

$$\begin{aligned}
y(t) &= (2e^{-3t} - e^{-2t})u(t) * e^{-2t}u(t) = 2e^{-3t}u(t) * e^{-2t}u(t) - e^{-2t}u(t) * e^{-2t}u(t) \\
&= \left[ \frac{2(e^{-2t} - e^{-3t})}{1} - te^{-2t} \right] u(t) \\
&= [(2-t)e^{-2t} - 2e^{-3t}]u(t)
\end{aligned}$$

2.4-6

$$\begin{aligned}
y(t) &= (1-2t)e^{-2t}u(t) * u(t) = e^{-2t}u(t) * u(t) - 2te^{-2t}u(t) * u(t) \\
&= \left[ \left( \frac{1-e^{-2t}}{2} \right) - \left( \frac{1}{2} - \frac{1}{2}e^{-2t} - te^{-2t} \right) \right] u(t) \\
&= te^{-2t}u(t)
\end{aligned}$$

2.4-7 (a) For  $y(t) = 4e^{-2t} \cos 3t u(t) * u(t)$ , We use pair 12 with  $\alpha = 2$ ,  $\beta = 3$ ,  $\theta = 0$ ,  $\lambda = 0$ . Therefore

$$\phi = \tan^{-1} \left[ \frac{-3}{2} \right] = -56.31^\circ$$

and

$$\begin{aligned}
y(t) &= 4 \left[ \frac{\cos(56.31^\circ) - e^{-2t} \cos(3t + 56.31^\circ)}{\sqrt{4+9}} \right] u(t) \\
&= \frac{4}{\sqrt{13}} [0.555 - e^{-2t} \cos(3t + 56.31^\circ)] u(t)
\end{aligned}$$

(b) For  $y(t) = 4e^{-2t} \cos 3t u(t) * e^{-t}u(t)$ , we use pair 12 with  $\alpha = 2$ ,  $\beta = 3$ ,  $\theta = 0$ , and  $\lambda = -1$ . Therefore

$$\phi = \tan^{-1} \left[ \frac{-3}{1} \right] = -71.56^\circ$$

and

$$\begin{aligned}
y(t) &= 4 \left[ \frac{\cos(71.56^\circ)e^{-t} - e^{-2t} \cos(3t + 71.56^\circ)}{\sqrt{10}} \right] u(t) \\
&= \frac{4}{\sqrt{10}} [0.316e^{-t} - e^{-2t} \cos(3t + 71.56^\circ)] u(t) \\
&= 4 \left[ e^{-t} - \frac{1}{\sqrt{10}} e^{-2t} \cos(3t + 71.56^\circ) \right] u(t)
\end{aligned}$$

2.4-8 (a)  $y(t) = e^{-t}u(t) * e^{-2t}u(t) = (e^{-t} - e^{-2t})u(t)$

(b)  $e^{-2(t-3)}u(t) = e^6 e^{-2t}u(t)$ , and  $y(t) = e^6 [e^{-t}u(t) * e^{-2t}u(t)] = e^6(e^{-t} - e^{-2t})u(t)$

(c)  $e^{-2t}u(t-3) = e^{-6} e^{-2(t-3)}u(t-3)$ . Now from the result in part (a) and the shift property of the convolution [Eq. (2.63)]:

$$y(t) = e^{-6} [e^{-(t-3)}u(t) - e^{-2(t-3)}] u(t-3)$$

(d)  $f(t) = u(t) - u(t-1)$ . Now  $y_1(t)$ , the system response to  $u(t)$  is given by

$$y_1(t) = e^{-t}u(t) * u(t) = (1 - e^{-t})u(t)$$

The system response to  $u(t-1)$  is  $y_1(t-1)$  because of time-invariance property. Therefore the response  $y(t)$  to  $f(t) = u(t) - u(t-1)$  is given by

$$y(t) = y_1(t) - y_1(t-1) = (1 - e^{-t})u(t) - [1 - e^{-(t-1)}]u(t-1)$$



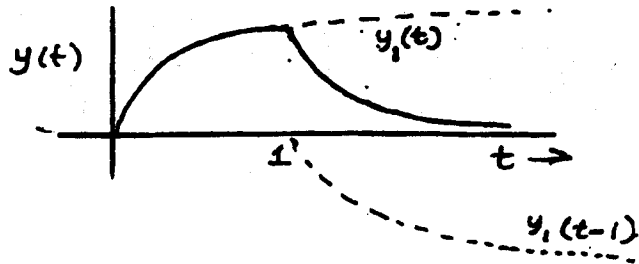

Fig. S2.4-8d

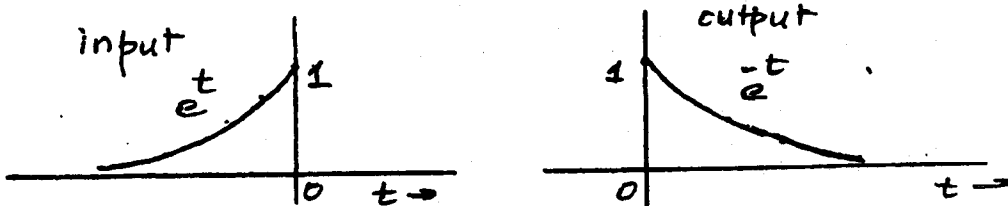

Fig. S2.4-9

The response is shown in Fig. S2.4-8.

2.4-9

$$\begin{aligned}
 y(t) &= [-\delta(t) + 2e^{-t}u(t)] * e^t u(-t) \\
 &= -\delta(t) * e^t u(-t) + 2e^{-t}u(t) * e^t u(-t) \\
 &= -e^t u(-t) + [e^{-t}u(t) + e^t u(-t)] \\
 &= e^{-t}u(t)
 \end{aligned}$$

2.4-10

$$\frac{1}{t^2+1} * u(t) = \int_{-\infty}^{\infty} \frac{1}{r^2+1} u(t-r) dr$$

Because  $u(t-r) = 1$  for  $r < t$  and is 0 for  $r > t$ , we need integrate only up to  $r = t$ .

$$\frac{1}{t^2+1} * u(t) = \int_{-\infty}^t \frac{1}{r^2+1} dr = \tan^{-1} r \Big|_{-\infty}^t = \tan^{-1} t + \frac{\pi}{2}$$

Figure S2.4-10 shows  $\frac{1}{t^2+1}$  and  $c(t)$  (the result of the convolution)

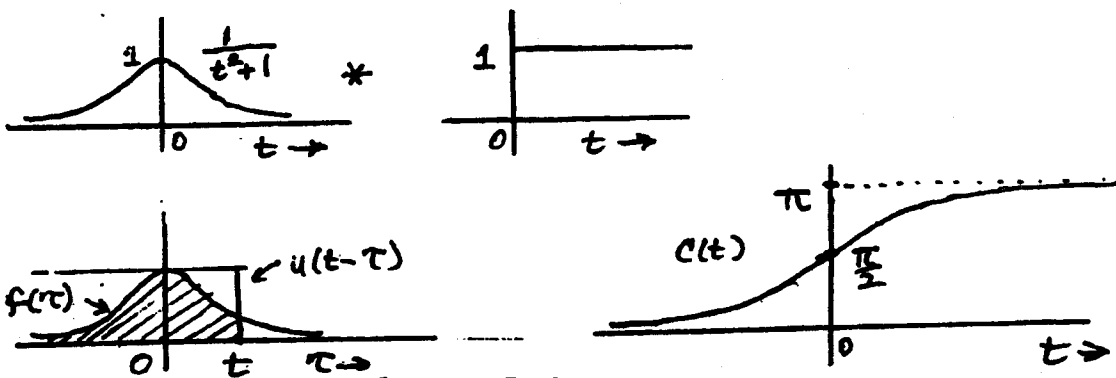

Fig. S2.4-10

2.4-11 For  $t < 2\pi$  (see Fig. S2.4-11)

$$c(t) = f(t) * g(t) = \int_0^t \sin r dr = 1 - \cos t \quad 0 \leq t \leq 2\pi$$

For  $t \geq 2\pi$ , the area of one cycle is zero and

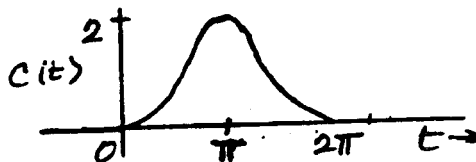
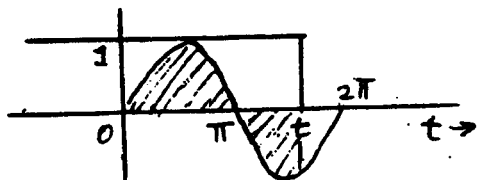

Fig. S2.4-11

$$f(t) + g(t) = 0 \quad t \geq 2\pi \text{ and } t < 0$$

2.4-12 For  $0 \leq t \leq 2\pi$  (see Fig. S2.4-12a)

$$f(t) + g(t) = \int_0^t \sin r \, dr = 1 - \cos t \quad 0 \leq t \leq 2\pi$$

For  $2\pi \leq t \leq 4\pi$  (Fig. S2.4-12b)

$$f(t) + g(t) = \int_{t-2\pi}^{2\pi} \sin r \, dr = \cos t - 1 \quad 2\pi \leq t \leq 4\pi$$

For  $t > 4\pi$  (also for  $t < 0$ ),  $f(t) + g(t) = 0$ . Figure S2.4-12c shows  $c(t)$ .

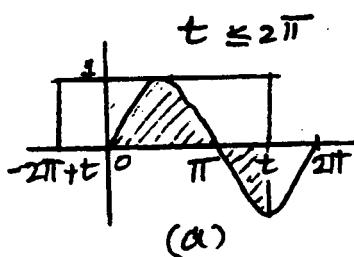

(a)

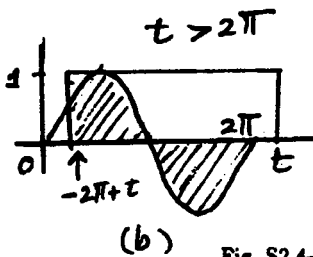

(b)

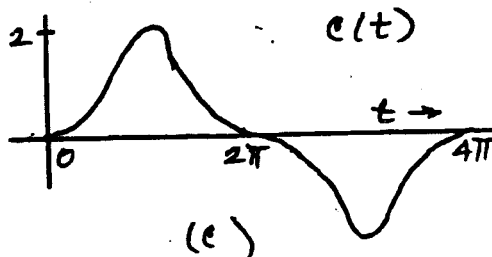

(c)

Fig. S2.4-12

2.4-13 (a)

$$c(t) = \int_{2+t}^{2.5+t} AB \, dr = \frac{AB}{2} \quad 0 \leq t \leq 0.5$$

$$c(t) = \int_{2+t}^3 AB \, dr = AB(1-t) \quad 0.5 \leq t \leq 1$$

$$c(t) = \int_2^{2.5+t} AB \, dr = AB(t+0.5) \quad -0.5 \leq t \leq 0$$

$$c(t) = 0 \quad t \geq 1 \text{ or } t \leq -0.5$$

(b)

$$c(t) = \int_{1.5+t}^{2.5} AB \, dr = AB(1-t) \quad 0 \leq t \leq 1$$

$$c(t) = \int_{1.5}^{2.5+t} AB \, dr = AB(t+1) \quad -1 \leq t \leq 0$$

$$c(t) = 0 \quad \text{for } |t| \geq 1$$

(c)

$$c(t) = \int_{-1+t}^{2+t} dr = 3 \quad t > -1$$

$$c(t) = \int_{-2}^{2+t} dr = t+4 \quad -1 \geq t \geq -4$$

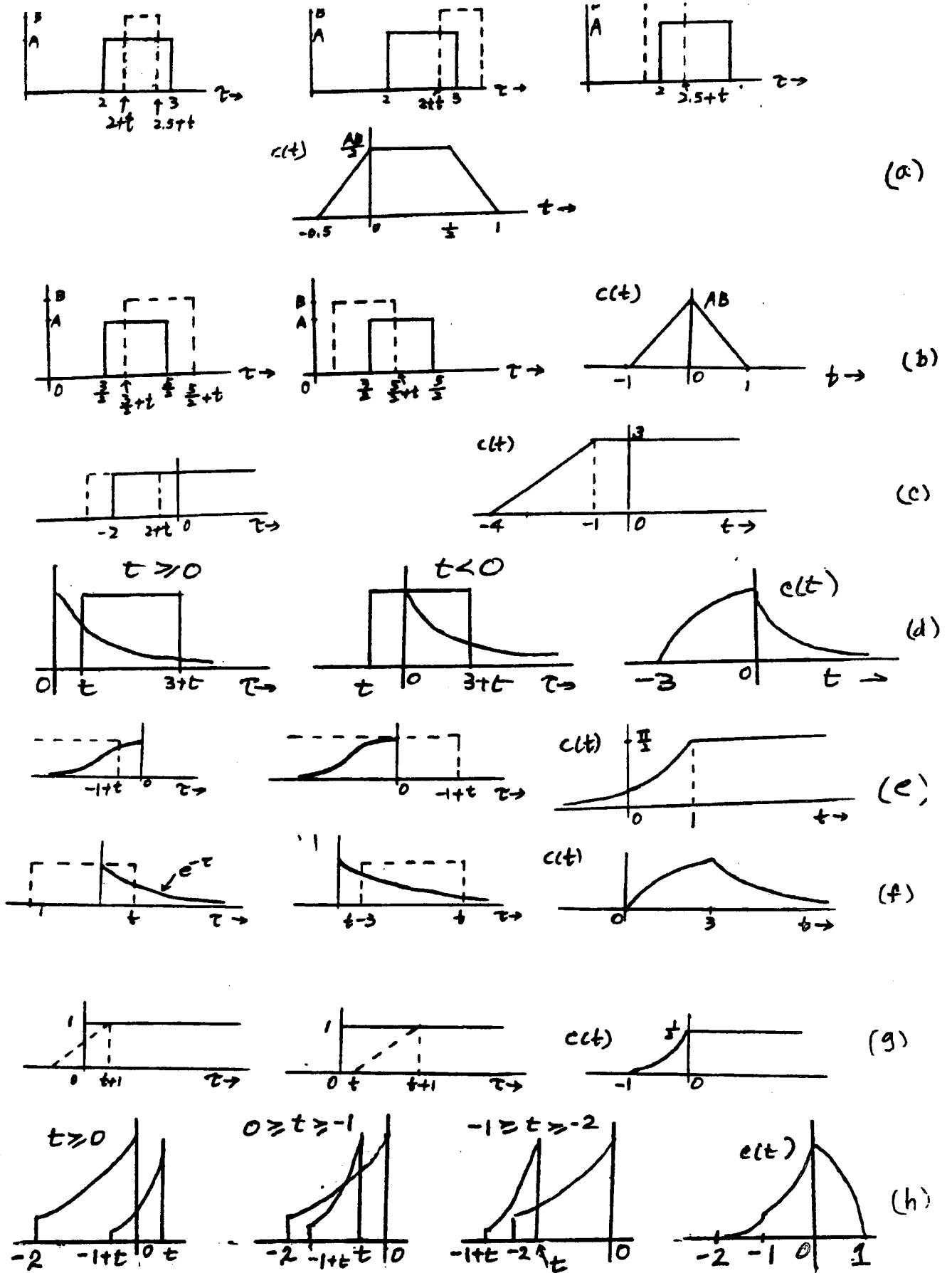

Fig. S2.4-13



$$c(t) = 0 \quad t \leq -4$$

(d)

$$\begin{aligned} c(t) &= \int_t^{3+t} e^{-r} dr = e^{-t}(1 - e^{-3}) = 0.95e^{-t} \quad t \geq 0 \\ &= \int_0^{3+t} e^{-r} dr = 1 - e^{-(3+t)} = 1 - 0.0498e^{-t} \quad 0 \geq t \geq -3 \\ &= 0 \quad t \leq -3 \end{aligned}$$

(e)

$$\begin{aligned} c(t) &= \int_{-\infty}^{-1+t} \frac{1}{r^2+1} dr = \tan^{-1}(t-1) + \frac{\pi}{2} \quad t \leq 1 \\ c(t) &= \int_{-\infty}^0 \frac{1}{r^2+1} dr = \tan^{-1} r \Big|_{-\infty}^0 = \frac{\pi}{2} \quad t \geq 1 \end{aligned}$$

(f)

$$\begin{aligned} c(t) &= \int_0^t e^{-r} dr = 1 - e^{-t} \quad 0 \leq t \leq 3 \\ c(t) &= \int_{t-3}^t e^{-r} dr = e^{-(t-3)} - e^{-t} \quad t \geq 3 \\ c(t) &= 0 \quad t \leq 0 \end{aligned}$$

(g) This problem is more conveniently solved by inverting  $f_1(t)$  rather than  $f_2(t)$

$$\begin{aligned} c(t) &= \int_t^{t+1} (r-t) dr = \frac{1}{2} \quad t \geq 0 \\ c(t) &= \int_0^{t+1} (r-t) dr = \frac{1}{2}(1-t^2) \quad 0 \geq t \geq -1 \\ c(t) &= 0 \quad \text{for } t \geq 0 \end{aligned}$$

(h)  $f_1(t) = e^t$ ,  $f_2(t) = e^{-2t}$ ,  $f_1(r) = e^r$ ,  $f_2(t-r) = e^{-2(t-r)}$ .

$$\begin{aligned} c(t) &= \int_{-1+t}^0 e^r e^{-2(t-r)} dr = e^{-2t} \int_{-1+t}^0 e^{3r} dr = \frac{1}{3}[e^{-2t} - e^{t-3}] \quad 0 \leq t \leq 1 \\ c(t) &= \int_{-1+t}^t e^r e^{-2(t-r)} dr = e^{-2t} \int_{-1+t}^t e^{3r} dr = \frac{1}{3}[e^t - e^{t-3}] \quad 0 \geq t \geq -1 \\ c(t) &= \int_{-2}^t e^r e^{-2(t-r)} dr = e^{-2t} \int_{-2}^t e^{3r} dr = \frac{1}{3}[e^t - e^{-2(t+2)}] \quad -1 \geq t \geq -2 \\ c(t) &= 0 \quad t \leq -2 \end{aligned}$$

2.4-14 An element of length  $\Delta r$  at point  $u\Delta r$  has a charge  $f(u\Delta r)\Delta r$  (Fig. S2.4-14). The electric field due to this charge at point  $z$  is

$$\Delta E = \frac{f(u\Delta r)\Delta r}{4\pi\epsilon(z - u\Delta r)^2}$$

The total field due to the charge along the entire length is

$$\begin{aligned} E(z) &= \lim_{\Delta r \rightarrow 0} \sum_{u=-\infty}^{\infty} \frac{f(u\Delta r)\Delta r}{4\pi\epsilon(z - u\Delta r)^2} \\ &= \int_{-\infty}^{\infty} \frac{f(r)}{4\pi\epsilon(z - r)^2} dr = f(z) \circ \frac{1}{4\pi\epsilon z} \end{aligned}$$

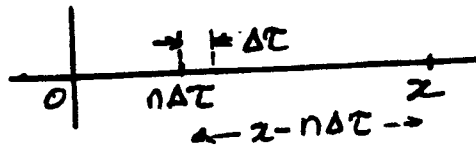

Fig. S2.4-14

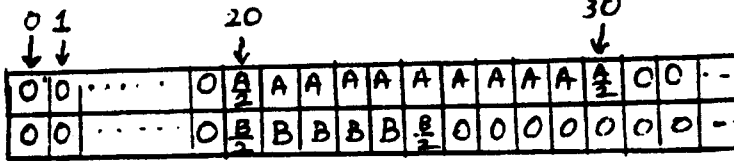
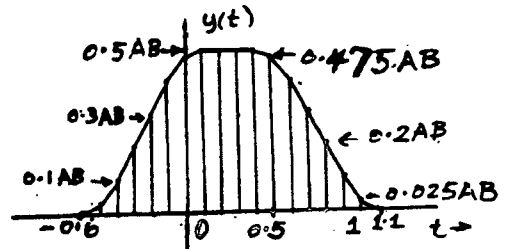

Fig. S2.5-1



2.4-15 The system response to  $u(t)$  is  $g(t)$  and the response to step  $u(t - \tau)$  is  $g(t - \tau)$ . The input  $f(t)$  is made up of step components. The step component at  $\tau$  has a height  $\Delta f$  which can be expressed as

$$\Delta f = \frac{\Delta f}{\Delta \tau} \Delta \tau = f(\tau) \Delta \tau$$

The step component at  $n\Delta\tau$  has a height  $f(n\Delta\tau)\Delta\tau$  and it can be expressed as  $[f(n\Delta\tau)\Delta\tau]u(t - n\Delta\tau)$ . Its response  $\Delta y(t)$  is

$$\Delta y(t) = [f(n\Delta\tau)\Delta\tau]g(t - n\Delta\tau)$$

The total response due to all components is

$$\begin{aligned} y(t) &= \lim_{\Delta\tau \rightarrow 0} \sum_{n=-\infty}^{\infty} f(n\Delta\tau)g(t - n\Delta\tau)\Delta\tau \\ &= \int_{-\infty}^{\infty} f(\tau)g(t - \tau) d\tau = f(\tau) * g(\tau) \end{aligned}$$

2.4-16 Indicating the input and corresponding response graphically by an arrow, we have

$$\begin{aligned} f(t) &\longrightarrow y(t) \\ f(t - T) &\longrightarrow y(t - T) \quad (\text{by Time-invariance}) \\ f(t) - f(t - T) &\longrightarrow y(t) - y(t - T) \quad (\text{by linearity}) \end{aligned}$$

Therefore

$$\lim_{T \rightarrow 0} \frac{1}{T} [f(t) - f(t - T)] \longrightarrow \lim_{T \rightarrow 0} \frac{1}{T} [y(t) - y(t - T)]$$

The left-hand side is  $f(t)$  and the right-hand side is  $y(t)$ . Therefore

$$f(t) \longrightarrow y(t)$$

Next we recognize that

$$f(t) * u(t) = \int_0^t f(\tau)u(t - \tau) d\tau = \int_0^t f(\tau) d\tau \quad (1)$$

This follows from the fact that  $u(t - \tau) = 1$  because  $0 \leq \tau \leq t$ . Now the response to  $\int_0^t f(\tau) d\tau$  is

$$[f(t) * u(t)] * h(t) = [f(t) * h(t)] * u(t) = y(t) * u(t)$$

But as shown in Eq. (1),  $y(t) * u(t)$  is  $\int_0^t y(\tau) d\tau$ . Therefore the response to input  $\int_0^t f(\tau) d\tau$  is  $\int_0^t y(\tau) d\tau$ .

2.5-1 The figure shows  $f_1[m]$  and  $f_2[-m]$  tapes. To find  $y[0]$ , we multiply the sample values in the adjacent slots, add all the products and multiply it by  $T$ . This yields:

$$y[0] = T \left( \frac{1}{4}AB + 4AB + \frac{1}{2}AB \right) = 4.75ABT = 0.475AB$$

Similarly to find  $y[1]$  (the response at  $t = 0.1$ ), we right-shift  $f_2[-m]$  tape by one slot and repeat the procedure to obtain

$$y[1] = T \left( \frac{1}{2}AB + 4AB + \frac{1}{2}AB \right) = 5ABT = 0.5AB$$

To obtain  $y[r]$ , we right-shift  $f_2[-m]$  tape by  $r$  slots and repeat the procedure. For negative  $r$ , the tape is left-shifted by  $r$  slots. Using this procedure, we obtain  $y[k] = 0$  for  $k < -6$  and  $k \geq 11$ , which corresponds to  $t \leq -0.6$  and  $t \geq 1.1$ . Similarly, we find  $y[k] = 5ABT = 0.5AB$  for  $k = 1, 2, 3$ , and  $4$ ,  $y[k] = 0.475AB$  for  $k = 0$  and  $5$ ,  $y[k] = 0.025AB$  for  $k = -5$  and  $10$  ( $t = -0.5$ , and  $1$ ). Figure S2.5-1 shows the response  $y(t)$ .

2.5-2 We follow the procedure in Prob. 2.5-1. We obtain  $y[0] = 9.5ABT = 0.95AB$ , and  $y[\pm 1] = 9ABT = 0.9AB$  (corresponding to  $t = \pm 0.1$ ).  $y[\pm 10] = 0.25ABT = 0.025AB$  (corresponding to  $t = \pm 1$ ). Similarly We obtain  $y[k] = 0$  for  $|k| \geq 11$  which corresponds to  $|t| \geq 1.1$ . Figure S2.5-2 shows the plot of  $y[k]$ .

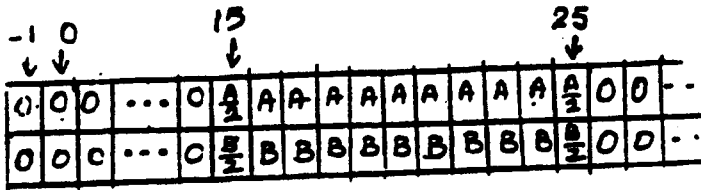
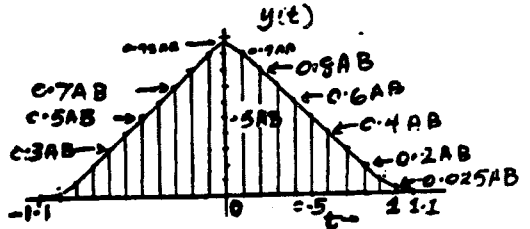

Fig. S2.5-2



2.5-3 Using the procedure in Prob. 2.5-1, we find  $y[0] = 30T = 3$ . Figure S2.5-3 shows the plot of  $y[k]$ . Observe that  $y[k] = 0$  for  $k \leq -41$  which corresponds to  $t \leq -4.1$ .

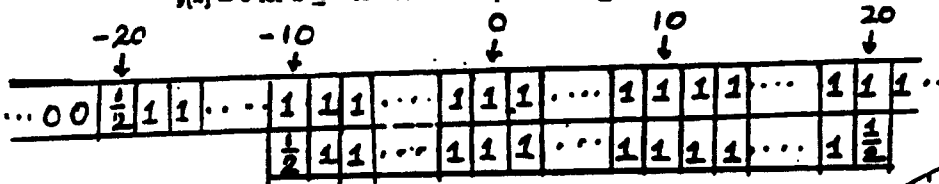
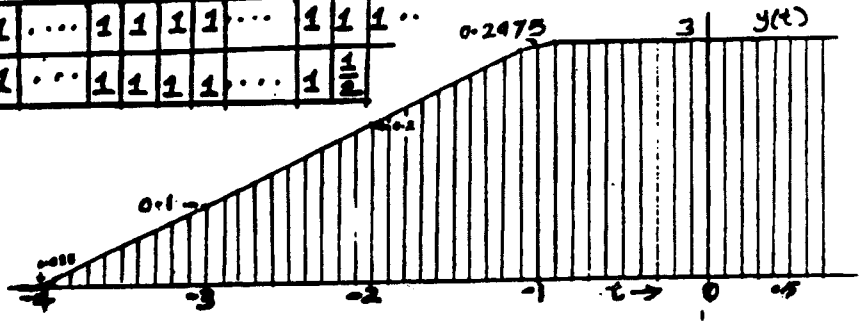

Fig. S2.5-3



2.6-1

(a)  $\lambda^2 + 8\lambda + 12 = (\lambda + 2)(\lambda + 6)$

Both roots are in LHP. The system is asymptotically stable.

(b)  $\lambda(\lambda^2 + 3\lambda + 2) = \lambda(\lambda + 1)(\lambda + 2)$

Roots are 0, -1, -2. One root on imaginary axis and none in RHP. The system is marginally stable.

(c)  $\lambda^2(\lambda^2 + 2) = \lambda^2(\lambda + j\sqrt{2})(\lambda - j\sqrt{2})$

Roots are 0 (repeated twice) and  $\pm j\sqrt{2}$ . Multiple roots on imaginary axis. The system is unstable.

(d)  $(\lambda + 1)(\lambda^2 - 6\lambda + 5) = (\lambda + 1)(\lambda - 1)(\lambda - 5)$

Roots are -1, 1 and 5. Two roots in RHP. The system is unstable.

2.6-2

(a)  $(\lambda + 1)(\lambda^2 + 2\lambda + 5)^2 = (\lambda + 1)(\lambda + 1 - j2)^2(\lambda + 1 + j2)^2$

Roots -1,  $-1 \pm j2$  (repeated twice) are all in LHP. The system is asymptotically stable.

(b)  $(\lambda + 1)(\lambda^2 + 9) = (\lambda + 1)(\lambda + j3)(\lambda - j3)$

Roots are -1,  $\pm j3$ . Two (simple) roots on imaginary axis, none in RHP. The system is marginally stable.

(c)  $(\lambda + 1)(\lambda^2 + 9)^2 = (\lambda + 1)(\lambda + j3)^2(\lambda - j3)^2$

Roots are -1 and  $\pm j3$  repeated twice. Multiple roots on imaginary axis. The system is unstable.

(d)  $(\lambda^2 + 1)(\lambda^2 + 4)(\lambda^2 + 9) = (\lambda + j1)(\lambda - j1)(\lambda + j2)(\lambda - j2)(\lambda + j3)(\lambda - j3)$

The roots are  $\pm j1$ ,  $\pm j2$  and  $\pm j3$ . All roots are simple and on imaginary axis. None in RHP. The system is marginally stable.

2.6-3

(a) Because  $u(t) = e^{0t}u(t)$ , the characteristic root is 0.

(b) The root lies on the imaginary axis, and the system is marginally stable.

(c)  $\int_0^\infty h(t) dt = \infty$



The system is BIBO unstable.

(d) The integral of  $\delta(t)$  is  $u(t)$ . The system response to  $\delta(t)$  is  $u(t)$ . Clearly, the system is an ideal integrator.

2.6-4 Assume that a system exists that violates Eq. (2.85) and yet produces a bounded output for every bounded input. The response at  $t = t_1$  is

$$y(t_1) = \int_0^{\infty} h(\tau) f(t_1 - \tau) d\tau$$

Consider a bounded input  $f(t)$  such that at some instant  $t_1$

$$f(t_1 - \tau) = \begin{cases} 1 & \text{if } h(\tau) > 0 \\ -1 & \text{if } h(\tau) < 0 \end{cases}$$

In this case

$$h(\tau) f(t_1 - \tau) = |h(\tau)|$$

and

$$y(t_1) = \int_0^{\infty} |h(\tau)| d\tau = \infty$$

This violates the assumption.

2.7-1 (a) The time-constant (rise-time) of the system is  $T_h = 10^{-5}$ . The rate of pulse communication  $< \frac{1}{T_h} = 10^5$  pulses/sec. The channel cannot transmit million pulses/second.  
 (b) The bandwidth of the channel is

$$B = \frac{1}{T_h} = 10^5 \text{ Hz}$$

The channel can transmit audio signal of bandwidth 15 kHz readily.

2.7-2

$$T_h = \frac{1}{B} = \frac{1}{10^4} = 10^{-4} = 0.1 \text{ ms}$$

The received pulse width =  $(0.5 + 0.1) = 0.6$  ms. Each pulse takes up 0.6 ms interval. The maximum pulse rate (to avoid interference between successive pulses) is

$$\frac{1}{0.6 \times 10^{-3}} \approx 1667 \text{ pulses/sec}$$

2.8-1

$$\lambda^2 + 7\lambda + 12 = (\lambda + 3)(\lambda + 4)$$

The natural response is

$$y_n(t) = K_1 e^{-3t} + K_2 e^{-4t}$$

(a) For  $f(t) = u(t) = e^{0t} u(t)$ ,  $y_0(t) = H(0) = \frac{F(0)}{Q(0)} = \frac{1}{6}$

$$y(t) = K_1 e^{-3t} + K_2 e^{-4t} + \frac{1}{6}$$

$$\dot{y}(t) = -3K_1 e^{-3t} - 4K_2 e^{-4t}$$

Setting  $t = 0$  and substituting initial conditions, we obtain

$$\left. \begin{aligned} 0 &= K_1 + K_2 + \frac{1}{6} \\ 1 &= -3K_1 - 4K_2 \end{aligned} \right\} \implies \begin{aligned} K_1 &= -\frac{2}{3} \\ K_2 &= \frac{1}{2} \end{aligned}$$

and

$$y(t) = -\frac{2}{3} e^{-3t} + \frac{1}{2} e^{-4t} + \frac{1}{6} \quad t \geq 0$$

(b)  $f(t) = e^{-t} u(t)$ ,  $y_0(t) = H(-1) = \frac{F(-1)}{Q(-1)} = \frac{1}{6}$

$$y(t) = K_1 e^{-3t} + K_2 e^{-4t} + \frac{1}{6} e^{-t}$$

$$\dot{y}(t) = -3K_1 e^{-3t} - 4K_2 e^{-4t} - \frac{1}{6} e^{-t}$$

Setting  $t = 0$ , and substituting initial conditions yields

$$\left. \begin{aligned} 0 &= K_1 + K_2 + \frac{1}{6} \\ 1 &= -3K_1 - 4K_2 - \frac{1}{6} \end{aligned} \right\} \Rightarrow \begin{aligned} K_1 &= -\frac{1}{2} \\ K_2 &= -\frac{2}{3} \end{aligned}$$

and

$$y(t) = \frac{1}{2}e^{-3t} - \frac{2}{3}e^{-4t} + \frac{1}{6}e^{-t} \quad t \geq 0$$

(c)  $f(t) = e^{-2t}u(t)$ ,  $y_\phi(t) = H(-2) = 0$

$$\begin{aligned} y(t) &= K_1e^{-3t} + K_2e^{-4t} \\ \dot{y}(t) &= -3K_1e^{-3t} - 4K_2e^{-4t} \end{aligned}$$

Setting  $t = 0$ , and substituting initial conditions yields

$$\left. \begin{aligned} 0 &= K_1 + K_2 \\ 1 &= -3K_1 - 4K_2 \end{aligned} \right\} \Rightarrow \begin{aligned} K_1 &= 1 \\ K_2 &= -1 \end{aligned}$$

and

$$y(t) = e^{-3t} - e^{-4t} \quad t \geq 0$$

2.8-2  $\lambda^2 + 6\lambda + 25 = (\lambda + 3 - j4)(\lambda + 3 + j4)$  characteristic roots are  $-3 \pm j4$

$$y_n(t) = Ke^{-3t} \cos(4t + \theta)$$

For  $f(t) = u(t)$ ,  $y_\phi(t) = H(0) = \frac{3}{25}$  so that

$$\begin{aligned} y(t) &= Ke^{-3t} \cos(4t + \theta) + \frac{3}{25} \\ \dot{y}(t) &= -3Ke^{-3t} \cos(4t + \theta) - 4Ke^{-3t} \sin(4t + \theta) \end{aligned}$$

Setting  $t = 0$ , and substituting initial conditions yields

$$\left. \begin{aligned} 0 &= K \cos \theta + \frac{3}{25} \\ 2 &= -3K \cos \theta - 4K \sin \theta \end{aligned} \right\} \Rightarrow \left. \begin{aligned} K \cos \theta &= \frac{-3}{25} \\ K \sin \theta &= \frac{-41}{100} \end{aligned} \right\} \Rightarrow \begin{aligned} K &= 0.427 \\ \theta &= -106.3 \end{aligned}$$

and

$$y(t) = 0.427e^{-3t} \cos(4t - 106.3^\circ) + \frac{3}{25} \quad t \geq 0$$

2.8-3 Characteristic polynomial is  $\lambda^2 + 4\lambda + 4 = (\lambda + 2)^2$ . The roots are  $-2$  repeated twice.

$$y_n(t) = (K_1 + K_2t)e^{-2t}$$

(a) For  $f(t) = e^{-3t}u(t)$ ,  $y_\phi(t) = H(-3) = -2e^{-3t}$

$$\begin{aligned} y(t) &= (K_1 + K_2t)e^{-2t} - 2e^{-3t} \\ \dot{y}(t) &= -2(K_1 + K_2t)e^{-2t} + K_2e^{-2t} + 6e^{-3t} \end{aligned}$$

Setting  $t = 0$ , and substituting initial conditions yields

$$\left. \begin{aligned} \frac{3}{4} &= K_1 - 2 \\ 5 &= -2K_1 + K_2 + 6 \end{aligned} \right\} \Rightarrow \begin{aligned} K_1 &= \frac{17}{4} \\ K_2 &= \frac{11}{2} \end{aligned}$$

and

$$y(t) = \left(\frac{17}{4} + \frac{11}{2}t\right)e^{-2t} - 2e^{-3t} \quad t \geq 0$$

(b)  $f(t) = e^{-t}u(t)$ ,  $y_\phi(t) = H(-1)e^{-t} = 0$

$$\begin{aligned} y(t) &= (K_1 + K_2t)e^{-2t} \\ \dot{y}(t) &= -2(K_1 + K_2t)e^{-2t} + K_2e^{-2t} \end{aligned}$$

Setting  $t = 0$ , and substituting initial conditions yields

$$\left. \begin{aligned} \frac{2}{4} &= K_1 \\ 5 &= -2K_1 + K_2 \end{aligned} \right\} \Rightarrow \begin{aligned} K_1 &= \frac{2}{4} \\ K_2 &= \frac{19}{2} \end{aligned}$$

and

$$y(t) = \left(\frac{2}{4} + \frac{19}{2}t\right)e^{-2t} \quad t \geq 0$$

2.8-4 Because  $(\lambda^2 + 2\lambda) = \lambda(\lambda + 2)$ , the characteristic roots are 0 and -2.

$$y_n(t) = K_1 + K_2e^{-2t}$$

In this case  $f(t) = u(t)$ . The input itself is a characteristic mode. Therefore

$$y_\phi(t) = \beta t$$

But  $y_\phi(t)$  satisfied the system equation

$$(D^2 + 2D)y_\phi(t) = (D + 1)y(t) = \ddot{y}_\phi(t) + 2\dot{y}_\phi(t) = f(t) + f(t)$$

Substituting  $f(t) = u(t)$  and  $y_\phi(t) = \beta t$ , we obtain

$$0 + 2\beta = 0 + 1 \Rightarrow \beta = \frac{1}{2}$$

Therefore  $y_\phi(t) = \frac{1}{2}t$ .

$$\begin{aligned} y(t) &= K_1 + K_2e^{-2t} + \frac{1}{2}t \\ \dot{y}(t) &= -2K_2e^{-2t} + \frac{1}{2} \end{aligned}$$

Setting  $t = 0$ , and substituting initial conditions yields

$$\left. \begin{aligned} 2 &= K_1 + K_2 \\ 1 &= -2K_2 + \frac{1}{2} \end{aligned} \right\} \Rightarrow \begin{aligned} K_1 &= \frac{2}{4} \\ K_2 &= -\frac{1}{4} \end{aligned}$$

and

$$y(t) = \frac{2}{4} - \frac{1}{4}e^{-2t} + \frac{1}{2}t \quad t \geq 0$$

2.8-5 the natural response  $y_n(t)$  is found in Prob. 2.8-1:

$$y_n(t) = K_1e^{-3t} + K_2e^{-4t}$$

The input  $f(t) = e^{-3t}$  is a characteristic mode. Therefore

$$y_\phi(t) = \beta te^{-3t}$$

Also  $y_\phi(t)$  satisfies the system equation:

$$(D^2 + 7D + 12)y_\phi(t) = (D + 2)f(t)$$

or

$$\ddot{y}_\phi(t) + 7\dot{y}_\phi(t) + 12y_\phi(t) = \dot{f}(t) + 2f(t)$$

Substituting  $f(t) = e^{-3t}$  and  $y_\phi(t) = \beta te^{-3t}$  in this equation yields

$$(9\beta t - 6\beta)e^{-3t} + 7(-3\beta t + \beta)e^{-3t} + 12\beta te^{-3t} = -3e^{-3t} + 2e^{-3t}$$

or

$$\beta e^{-3t} = -e^{-3t} \Rightarrow \beta = -1$$

Therefore

$$\begin{aligned} y(t) &= K_1e^{-3t} + K_2e^{-4t} - te^{-3t} \\ \dot{y}(t) &= -3K_1e^{-3t} - 4K_2e^{-4t} + 3te^{-3t} - e^{-3t} \end{aligned}$$

Setting  $t = 0$ , and substituting initial conditions yields

$$\left. \begin{aligned} 0 &= K_1 + K_2 \\ 1 &= -3K_1 - 4K_2 - 1 \end{aligned} \right\} \Rightarrow \begin{aligned} K_1 &= 2 \\ K_2 &= -2 \end{aligned}$$

and

$$\begin{aligned} y(t) &= 2e^{-3t} - 2e^{-4t} - te^{-3t} \quad t \geq 0 \\ &= (2 - t)e^{-3t} - 2e^{-4t} \quad t \geq 0 \end{aligned}$$



# Chapter 3

3.1-1

$$\begin{aligned} y[k] &= y[k-1] + f[k] \\ &= y[k-1] \end{aligned}$$

Therefore

$$y[k] - y[k-1] = f[k]$$

Realization of this equation is shown in Fig. S3.1-1.

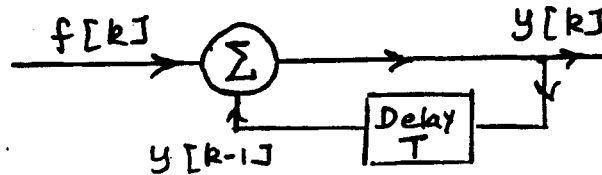

Fig. S3.1-1

3.1-2 The net growth rate of the native population is  $3.3 - 1.3 = 2\%$  per year. Assuming the immigrants enter at a uniform rate throughout the year, their birth and death rate will be  $(3.3/2)\%$  and  $(1.3/2)\%$ , respectively of the immigrants at the end of the year. The population  $p[k]$  at the beginning of the  $k$ th year is  $p[k-1]$  plus the net increase in the native population plus  $i[k-1]$ , the immigrants entering during  $(k-1)$ st year plus the net increase in the immigrant population for the year  $(k-1)$ .

$$\begin{aligned} p[k] &= p[k-1] + \frac{3.3-1.3}{100}p[k-1] + i[k-1] + \frac{3.3-1.3}{2 \times 100}i[k-1] \\ &= 1.02p[k-1] + 1.01i[k-1] \end{aligned}$$

or

$$p[k] - 1.02p[k-1] = 1.01i[k-1]$$

or

$$p[k+1] - 1.02p[k] = 1.01i[k]$$

3.1-3

$$y[k] = y[k-1] + Tf[k-1]$$

The realization is shown in Fig. S3.1-3.

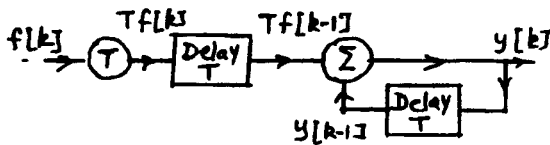

Digital Integrator realization

Fig. S3.1-3

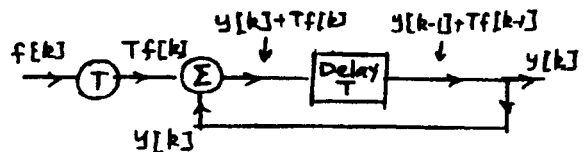

Alternate realization using a single delay

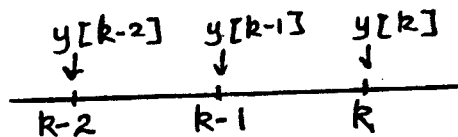

Figure S3.1-4

3.1-4 At the instant  $k$ , money which is for 2 or more years is  $y[k-2]$ . Money which is for 1 year is  $y[k-1] - y[k-2]$ . Hence

$$y[k] = 0.18y[k-2] + 0.12[y[k-1] - y[k-2]] + y[k-1] + f[k]$$

or

$$y[k] - 1.12y[k-1] - 0.06y[k-2] = f[k]$$

This can be alternatively expressed as

$$y[k+2] - 1.12y[k+1] - 0.06y[k] = f[k+2]$$

3.1-5

$$y[k] = \frac{1}{5}\{f[k] + f[k-1] + f[k-2] + f[k-3] + f[k-4]\}$$

The realization is shown in Fig. S3.1-5.

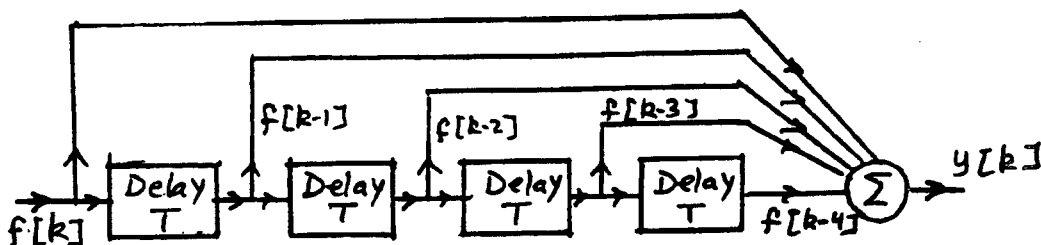

Fig. S3.1-5

3.1-6 The node equation at the  $k$ th node is  $i_1 + i_2 + i_3 = 0$ , or

$$\frac{v[k-1] - v[k]}{R} + \frac{v[k+1] - v[k]}{R} - \frac{v[k]}{aR} = 0$$

Therefore

$$a(v[k-1] + v[k+1] - 2v[k]) - v[k] = 0$$

or

$$v[k+1] - \left(2 + \frac{1}{a}\right)v[k] + v[k-1] = 0$$

that is

$$v[k+2] - \left(2 + \frac{1}{a}\right)v[k+1] + v[k] = 0$$

or

$$\left[E^2 - \left(2 + \frac{1}{a}\right)E + 1\right]v[k] = 0, \text{ that is } (E - 0.5)(E - 2)v[k] = 0$$

3.2-1 (a)

$$y[k+1] = 0.5y[k] \quad (1)$$

Setting  $k = -1$  and substituting  $y[-1] = 10$ , yields

$$y[0] = 0.5(10) = 5$$

Setting  $k = 0$ , and substituting  $y[0] = 5$ , yields

$$y[1] = 0.5(5) = 2.5$$

Setting  $k = 1$  in (1), and substituting  $y[1] = 2.5$ , yields

$$y[2] = 0.5(2.5) = 1.25$$

(b)

$$y[k+1] = -2y[k] + f[k+1] \quad (2)$$

Setting  $k = -1$ , and substituting  $y[-1] = 0$ ,  $f[0] = 1$ , yields

$$y[0] = 0 + 1 = 1$$

Setting  $k = 0$ , and substituting  $y[0] = 1$ ,  $f[1] = \frac{1}{2}$ , yields

$$y[1] = -2(1) + \frac{1}{2} = -2 + \frac{1}{2} = -1.632$$

Setting  $k = 1$  in (1), and substituting  $y[1] = -2 + \frac{1}{2}$ ,  $f[2] = \frac{1}{4}$ , yields

$$y[2] = -2(-2 + \frac{1}{2}) + \frac{1}{4} = 4 - \frac{2}{2} + \frac{1}{4} = 3.399$$

3.2-2

$$y[k] = 0.6y[k-1] + 0.16[k-2]$$

Setting  $k = 0$ , and substituting  $y[-1] = -25$ ,  $y[-2] = 0$ , yields

$$y[0] = 0.6(-25) + 0.16(0) = -15$$

Setting  $k = 1$ , and substituting  $y[-1] = 0$ ,  $y[0] = -15$ , yields

$$y[1] = 0.6(-15) + 0.16(-25) = -13$$

Setting  $k = 2$ , and substituting  $y[1] = -13$ ,  $y[0] = -15$ , yields

$$y[2] = 0.6(-13) + 0.16(-15) = -10.2$$

3.2-3 This equation can be expressed as

$$y[k+2] = -\frac{1}{4}y[k+1] - \frac{1}{18}y[k] + f[k+2]$$

Setting  $k = -2$ , and substituting  $y[-1] = y[-2] = 0$ ,  $f[0] = 100$ , yields

$$y[0] = -\frac{1}{4}(0) - \frac{1}{18}(0) + 100 = 100$$

Setting  $k = -1$ , and substituting  $y[-1] = 0$ ,  $y[0] = 100$ ,  $f[1] = 100$ , yields

$$y[1] = -\frac{1}{4}(100) - \frac{1}{18}(0) + 100 = 75$$

Setting  $k = 0$ , and substituting  $y[0] = 100$ ,  $y[1] = 75$ ,  $f[2] = 100$ , yields

$$y[2] = -\frac{1}{4}(75) - \frac{1}{18}(100) + 100 = 75$$

3.2-4

$$y[k+2] = -3y[k+1] - 2y[k] + f[k+2] + 3f[k+1] + 3f[k]$$

Setting  $k = -2$ , and substituting  $y[-1] = 3$ ,  $y[-2] = 2$ ,  $f[-1] = f[-2] = 0$ ,  $f[0] = 1$ , yields

$$y[0] = -3(3) - 2(2) + 1 + 3(0) + 3(0) = -12$$

Setting  $k = -1$ , and substituting  $y[0] = -12$ ,  $y[-1] = 3$ ,  $f[-1] = 0$ ,  $f[0] = 1$ ,  $f[1] = 3$ , yields

$$y[1] = -3(-12) - 2(3) + 3 + 3(1) + 3(0) = 36$$

Proceeding along same lines, we obtain

$$y[2] = -3(36) - 2(-12) + 9 + 3(3) + 3(1) = -63$$

3.2-5

$$y[k] = -2y[k-1] - y[k-2] + 2f[k] - f[k-1]$$

Setting  $k = 0$ , and substituting  $y[-1] = 2$ ,  $y[-2] = 3$ ,  $f[0] = 1$ ,  $f[-1] = 0$ , yields

$$y[0] = -2(2) - 3 + 2(1) - 0 = -5$$

Setting  $k = 1$ , and substituting  $y[0] = -5$ ,  $y[-1] = 2$ ,  $f[0] = 1$ ,  $f[1] = \frac{1}{3}$ , yields

$$y[1] = -2(-5) - (2) + 2(\frac{1}{3}) - 1 = 7.667$$

Setting  $k = 2$ , and substituting  $y[1] = 7.667$ ,  $y[0] = -5$ ,  $f[1] = \frac{1}{3}$ ,  $f[2] = \frac{1}{9}$ , yields

$$y[2] = -2(7.667) - (-5) + 2(\frac{1}{9}) - \frac{1}{3} = -5.445$$

3.3-1

$$(E^2 + 3E + 2)y[k] = 0$$

The characteristic equation is  $\gamma^2 + 3\gamma + 2 = (\gamma + 1)(\gamma + 2) = 0$ . Therefore

$$y[k] = c_1(-1)^k + c_2(-2)^k$$

Setting  $k = -1$  and  $-2$  and substituting initial conditions yields

$$\left. \begin{array}{l} 0 = -c_1 - \frac{1}{2}c_2 \\ 1 = c_1 + \frac{1}{4}c_2 \end{array} \right\} \Rightarrow \begin{array}{l} c_1 = 2 \\ c_2 = -4 \end{array}$$

$$y[k] = 2(-1)^k - 4(-2)^k \quad k \geq 0$$

3.3-2

$$(E^2 + 2E + 1)y[k] = 0$$

The characteristic equation is  $\gamma^2 + 2\gamma + 1 = (\gamma + 1)^2 = 0$ .

$$y[k] = (c_1 + c_2 k)(-1)^k$$

Setting  $k = -1$  and  $-2$  and substituting initial conditions yields

$$\left. \begin{array}{l} 1 = -c_1 + c_2 \\ 1 = c_1 - 2c_2 \end{array} \right\} \Rightarrow \begin{array}{l} c_1 = -3 \\ c_2 = -2 \end{array}$$

$$y[k] = -(3 + 2k)(-1)^k$$

3.3-3

$$(E^2 - 2E + 2)y[k] = 0$$

The characteristic equation is  $\gamma^2 - 2\gamma + 2 = (\gamma - 1 - j1)(\gamma - 1 + j1) = 0$ . The roots are  $1 \pm j1 = \sqrt{2}e^{\pm j\pi/4}$ .

$$y[k] = c(\sqrt{2})^k \cos(\frac{\pi}{4}k + \theta)$$

Setting  $k = -1$  and  $-2$  and substituting initial conditions yields

$$\begin{aligned} 1 &= \frac{c}{\sqrt{2}} \cos(-\frac{\pi}{4} + \theta) = \frac{c}{\sqrt{2}} (\frac{1}{\sqrt{2}} \cos \theta + \frac{1}{\sqrt{2}} \sin \theta) \\ 0 &= \frac{c}{2} \cos(-\frac{\pi}{2} + \theta) = \frac{c}{2} \sin \theta \end{aligned}$$

Solution of these two simultaneous equations yields

$$\left. \begin{array}{l} c \cos \theta = 2 \\ c \sin \theta = 0 \end{array} \right\} \Rightarrow \begin{array}{l} c = 2 \\ \theta = 0 \end{array}$$

$$y[k] = 2(\sqrt{2})^k \cos(\frac{\pi}{4}k)$$

3.3-4 Characteristic equation is  $\gamma^2 + 2\gamma + 2 = (\gamma + 1 - j1)(\gamma + 1 + j1) = 0$ . The roots are  $-1 \pm j1 = \sqrt{2}e^{\pm j3\pi/4}$ .

$$y[k] = c(\sqrt{2})^k \cos(\frac{3\pi}{4}k + \theta)$$

Setting  $k = 0, 1$ , and substituting initial conditions yields

$$\left. \begin{aligned} 0 &= c \cos \theta \\ 2 &= \sqrt{2}c \cos\left(\frac{3\pi}{4} + \theta\right) \end{aligned} \right\} \Rightarrow \begin{aligned} c &= 2 \\ \theta &= -\frac{\pi}{4} \end{aligned}$$

$$y[k] = 2(\sqrt{2})^k \cos\left(\frac{3\pi}{4}k - \frac{\pi}{4}\right) = 2(\sqrt{2})^k \sin\left(\frac{3\pi}{4}k\right)$$

3.3-5

$$y[k+2] + 4y[k] = 0$$

or

$$(E^2 + 4)y[k] = 0$$

The characteristic equation is  $\gamma^2 + 4 = (\gamma + j2)(\gamma - j2) = 0$ . The roots are  $\pm j2 = 2e^{\pm j\pi/2}$ .

$$y[k] = c(2)^k \cos\left(\frac{\pi}{2}k + \theta\right)$$

Setting  $k = 0, 1$ , and substituting initial conditions yields

$$\left. \begin{aligned} 1 &= c \cos \theta \\ 2 &= 2c \cos\left(\frac{\pi}{2} + \theta\right) = -2c \sin \theta \end{aligned} \right\} \Rightarrow \left. \begin{aligned} c \cos \theta &= 1 \\ c \sin \theta &= -1 \end{aligned} \right\} \Rightarrow \begin{aligned} c &= \sqrt{2} \\ \theta &= -\frac{\pi}{4} \end{aligned}$$

$$y[k] = \sqrt{2}(2)^k \cos\left(\frac{\pi}{2}k - \frac{\pi}{4}\right)$$

3.3-6

$$v(k+2) - 2.5v(k+1) + v(k) = 0$$

The auxiliary conditions are  $v(0) = 100$ ,  $v(N) = 0$ .

$$(E^2 - 2.5E + 1)v[k] = 0$$

The characteristic equation is  $\gamma^2 - 2.5\gamma + 1 = (\gamma - 0.5)(\gamma - 2) = 0$ .

$$v(k) = c_1(0.5)^k + c_2(2)^k$$

Setting  $k = 0$  and  $N$ , and substituting  $v(0) = 100$ ,  $v(N) = 0$ , yields

$$\left. \begin{aligned} 100 &= c_1 + c_2 \\ 0 &= c_1(0.5)^N + c_2(2)^N \end{aligned} \right\} \Rightarrow \begin{aligned} c_1 &= \frac{100(2)^N}{2^N - (0.5)^N} \\ c_2 &= \frac{100(0.5)^N}{(0.5)^N - 2^N} \end{aligned}$$

$$v[k] = \frac{100}{2^N - (0.5)^N} [2^N (0.5)^k - (0.5)^N (2)^k] \quad k = 0, 1, \dots, N$$

3.4-1

$$(E + 2)y[k] = f[k]$$

The characteristic equation is  $\gamma + 2 = 0$ . The characteristic root is  $-2$ . Also  $a_0 = 2$ ,  $b_0 = 1$ . Therefore

$$h[k] = \frac{1}{2}\delta[k] + c(-2)^k \tag{1}$$

We need one value of  $h[k]$  to determine  $c$ . This is determined by iterative solution of

$$(E + 2)h[k] = \delta[k]$$

or

$$h[k+1] + 2h[k] = \delta[k]$$

Setting  $k = -1$ , and substituting  $h[-1] = \delta[-1] = 0$ , yields

$$h[0] = 0$$

Setting  $k = 0$  in Eq. (1) and using  $h[0] = 0$  yields

$$0 = \frac{1}{2} + c \Rightarrow c = -\frac{1}{2}$$

Therefore

$$h[k] = \frac{1}{2}\delta[k] - \frac{1}{2}(-2)^k u[k]$$



3.4-2 The characteristic root is  $-2$ ,  $b_0 = 0$ ,  $a_0 = 2$ . Therefore

$$h[k] = c(-2)^k \quad (1)$$

We need one value of  $h[k]$  to determine  $c$ . This is done by solving iteratively

$$h[k+1] + 2h[k] = \delta[k+1]$$

Setting  $k = -1$ , and substituting  $h[-1] = 0$ ,  $\delta[0] = 1$ , yields

$$h[0] = 1$$

Setting  $k = 0$  in Eq. (1) and using  $h[0] = 1$  yields

$$1 = c$$

and

$$h[k] = (-2)^k u[k]$$

3.4-3 Characteristic equation is  $\gamma^2 - 6\gamma + 9 = (\gamma - 3)^2 = 0$ . Also  $a_0 = 9$ ,  $b_0 = 0$ . Therefore

$$h[k] = (c_1 + c_2 k)3^k u[k] \quad (1)$$

We need two values of  $h[k]$  to determine  $c_1$  and  $c_2$ . This is found from iterative solution of

$$(E^2 - 6E + 9)h[k] = E\delta[k]$$

or

$$h[k+2] - 6h[k+1] + 9h[k] = \delta[k+1] \quad (2)$$

Also  $h[-1] = h[-2] = \delta[-1] = 0$  and  $\delta[0] = 1$ . Setting  $k = -2$  in (2) yields

$$h[0] - 6(0) + 9(0) = 0 \implies h[0] = 0$$

Setting  $k = -1$  in (2) yields

$$h[1] - 6(0) + 9(0) = 1 \implies h[1] = 1$$

Setting  $k = 0$  and  $1$  in Eq. (1) and substituting  $h[0] = 0$ ,  $h[1] = 1$  yields

$$\left. \begin{array}{l} 0 = c_1 \\ 1 = 3(c_1 + c_2) \end{array} \right\} \implies \begin{array}{l} c_1 = 0 \\ c_2 = \frac{1}{3} \end{array}$$

and

$$h[k] = \frac{1}{3}k(3)^k u[k]$$

3.4-4

$$(E^2 - 6E + 25)y[k] = (2E^2 - 4E)f[k]$$

The characteristic roots are  $5e^{\pm j0.923}$ ,  $b_0 = 0$ . Therefore

$$h[k] = c(5)^k \cos(0.923k + \theta)u[k] \quad (1)$$

We need two values of  $h[k]$  to determine  $c$  and  $\theta$ . This is done by solving iteratively

$$h[k] - 6h[k-1] + 25h[k-2] = 2\delta[k] - 4\delta[k-1] \quad (2)$$

Setting  $k = 0$  yields

$$h[0] - 6(0) + 25(0) = 2(1) - 4(0) \implies h[0] = 2$$

Setting  $k = 1$  in (2) yields

$$h[1] - 6(2) + 25(0) = 2(0) - 4 \implies h[1] = 8$$

Setting  $k = 0, 1$  in (1) and substituting  $h[0] = 2$ ,  $h[1] = 8$  yields

$$2 = c \cos \theta$$

$$8 = 5c \cos(0.923 + \theta) = 3.017c \cos \theta - 3.987c \sin \theta$$

Solution of these two equations yields

$$\left. \begin{aligned} c \cos \theta &= 2 \\ c \sin \theta &= -0.4931 \end{aligned} \right\} \Rightarrow \begin{aligned} c &= 2.061 \\ \theta &= -0.244 \text{ rad} \end{aligned}$$

and

$$h[k] = 2.061(5)^k \cos(0.923k - 0.244)u[k]$$

3.4-5 (a)

$$E^n y[k] = (b_n E^n + b_{n-1} E^{n-1} + \dots + b_0) f[k]$$

or

$$y[k] = b_n f[k] + b_{n-1} f[k-1] + \dots + b_0 f[k-n]$$

When  $f[k] = \delta[k]$ ,  $y[k] = h[k]$ . Therefore

$$h[k] = b_n \delta[k] + b_{n-1} \delta[k-1] + \dots + b_0 \delta[k-n]$$

(b) Here  $n = 3$ ,  $b_3 = 3$ ,  $b_2 = -5$ ,  $b_1 = 0$ ,  $b_0 = -2$ . Therefore

$$h[k] = 3\delta[k] - 5\delta[k-1] - 2\delta[k-3]$$

3.5-1

$$\begin{aligned} y[k] &= e^{-k} u[k] + (-2)^k u[k] = \left(\frac{1}{e}\right)^k u[k] + (-2)^k u[k] \\ &= \frac{(1/e)^{k+1} - (-2)^{k+1}}{(1/e) + 2} u[k] = \frac{e}{2e+1} [e^{-(k+1)} - (-2)^{k+1}] u[k] \end{aligned}$$

3.5-2

$$\begin{aligned} y[k] &= e^{-k} u[k] + \left\{ \frac{1}{2} \delta[k] - \frac{1}{2} (-2)^k u[k] \right\} \\ &= \frac{1}{2} e^{-k} u[k] + \delta[k] - \left(\frac{1}{e}\right)^k u[k] + \frac{1}{2} (-2)^k u[k] \\ &= \frac{1}{2} e^{-k} u[k] - \frac{(1/e)^{k+1} - (-2)^{k+1}}{2(1/e+2)} u[k] \\ &= \left\{ \frac{1}{2} e^{-k} - \frac{e}{2(2e+1)} [e^{-(k+1)} - (-2)^{k+1}] \right\} u[k] \end{aligned}$$

3.5-3

$$\begin{aligned} y[k] &= (3)^{k+2} u[k] + [(2)^k + 3(-5)^k] u[k] \\ &= 9[(3)^k u[k] + (2)^k u[k] + 3(3)^k u[k] + (-5)^k u[k]] \\ &= 9 \left\{ \frac{(3)^{k+1} - (-2)^{k+1}}{3-2} + 3 \frac{(3)^{k+1} - (-5)^{k+1}}{3+5} \right\} u[k] \\ &= 9 \left[ \frac{1}{6} (3)^{k+1} - (2)^{k+1} - \frac{3}{8} (-5)^{k+1} \right] u[k] \end{aligned}$$

3.5-4

$$\begin{aligned} y[k] &= (3)^{-k} u[k] + 3k(2)^k u[k] \\ &= 3 \left(\frac{1}{3}\right)^k u[k] + k(2)^k u[k] \\ &= 3 \frac{2/3}{(2-1/3)^2} \left[ \left(\frac{1}{3}\right)^k - (2)^k + \left(\frac{2-1/3}{1/3}\right) k(2)^k \right] u[k] \\ &= \frac{18}{5} [(3)^{-k} - (2)^k + 5k(2)^k] u[k] \end{aligned}$$

3.5-5

$$\begin{aligned} y[k] &= (3)^k \cos\left(\frac{\pi}{3}k - 0.5\right) u[k] + (2)^k u[k] \\ R &= [(3)^2 + (2)^2 - 2(3)(2)(0.5)]^{1/2} = \sqrt{7} \\ \phi &= \tan^{-1} \left[ \frac{3\sqrt{3}/2}{1.5-3} \right] = 1.761 \text{ rad} \end{aligned}$$

and

$$y[k] = \frac{1}{\sqrt{7}} \{ (3)^{k+1} \cos[\frac{\pi}{7}(k+1) - 2.261] - (2)^{k+1} \cos(2.261) \} u[k] \\ = \frac{1}{\sqrt{7}} \{ (3)^{k+1} \cos[\frac{\pi}{7}(k+1) - 2.261] + 0.637(2)^{k+1} \} u[k]$$

3.5-6 the characteristic root is  $-2$ . Therefore

$$y_0[k] = c(-2)^k$$

Setting  $k = -1$  and substituting  $y[-1] = 10$ , yields

$$10 = -\frac{c}{2} \implies c = -20$$

Therefore

$$y_0[k] = -20(-2)^k \quad k \geq 0$$

For this system  $h[k]$ , the unit impulse response is found in Prob. 3.4-2 to be

$$h[k] = (-2)^k u[k]$$

The zero-state response is

$$y[k] = e^{-k} u[k] * (-2)^k u[k]$$

This is found in Prob. 3.5-1 to be

$$y[k] = \frac{e}{2e+1} [e^{-(k+1)} - (-2)^{k+1}] u[k] \\ = \frac{e}{2e+1} [\frac{1}{e}(e)^{-k} + 2(-2)^k] u[k] \\ = [\frac{1}{2e+1}(e)^{-k} + \frac{2e}{2e+1}(-2)^k] u[k]$$

$$\text{Total Response} = y_0[k] + y[k] \\ = [-20(-2)^k + \frac{1}{2e+1}(e)^{-k} + \frac{2e}{2e+1}(-2)^k] u[k] \\ = \frac{1}{2e+1} [-(38e+20)(-2)^k + (e)^{-k}] u[k]$$

3.5-7 (a)

$$y[k] = 2^k u[k] * (0.5)^k u[k] \\ = \frac{2^{k+1} - (0.5)^{k+1}}{2-0.5} u[k] = \frac{2}{3} [2^{k+1} - (0.5)^{k+1}] u[k]$$

(b)

$$f[k] = 2^{(k-2)} u[k] = 2^{-2} 2^k u[k] = \frac{1}{4} 2^k u[k]$$

From the result in part (a), it follows that

$$y[k] = \frac{1}{8} \frac{2}{3} [2^{k+1} - (0.5)^{k+1}] u[k] = \frac{1}{12} [2^{k+1} - (0.5)^{k+1}] u[k]$$

(c)

$$f[k] = 2^k u[k-2] = 4 \{ 2^{(k-2)} u[k-2] \}$$

Note that  $2^{(k-2)} u[k-2]$  is the same as the input  $2^k u[k]$  in part (a) delayed by 2 units. Therefore from the shift property of the convolution, its response will be the same as in part (a) delayed by 2 units. The input here is  $4 \{ 2^{(k-2)} u[k-2] \}$ . Therefore

$$y[k] = 4 \frac{2}{3} [2^{k+1-2} - (0.5)^{k+1-2}] u[k-2] = \frac{8}{3} [2^{k-1} - (0.5)^{k-1}] u[k-2]$$

3.5-8 The equation describing this situation is [see Eq. (3.2b)]

$$(E - \gamma)y[k] = Ef[k] \quad \gamma = 1 + r = 1.01$$

The initial condition  $y[-1] = 0$ . Hence there is only zero-state component. The input is  $500u[k] - 1500\delta[k]$  because at  $k = 4$ , instead of depositing the usual \$500, she withdraws \$1000.

To find  $h[k]$ , we solve iteratively

$$(E - \gamma)h[k] = E\delta[k]$$

or

$$h[k+1] - \gamma h[k] = \delta[k+1]$$

Setting  $k = -1$  and substituting  $h[-1] = 0$ ,  $\delta[0] = 1$ , yields

$$h[0] = 1$$

Also, the characteristic root is  $\gamma$  and  $b_0 = 0$ . Therefore

$$h[k] = c\gamma^k u[k]$$

Setting  $k = 0$  and substituting  $h[0] = 1$  yields

$$1 = c$$

Therefore

$$h[k] = (\gamma)^k u[k] = (1.01)^k u[k]$$

The (zero-state) response is

$$\begin{aligned} y[k] &= (1.01)^k u[k] * f[k] \\ &= (1.01)^k u[k] * \{500u[k] - 1500\delta[k-4]\} \\ &= 500(1.01)^k u[k] * u[k] - 1500(1.01)^{k-4} u[k-4] \\ &= \frac{500}{0.91} [(1.01)^{k+1} - 1] u[k] - 1500(1.01)^{k-4} u[k-4] \\ &= 50000[(1.01)^{k+1} - 1] u[k] - 1500(1.01)^{k-4} u[k-4] \end{aligned}$$

3.5-9 This problem is identical to the savings account problem with negative initial deposit (loan). If  $M$  is the initial loan, then  $y[0] = -M$ . If  $y[k]$  is the loan balance, then [see Eq. (3.2b)]

$$y[k+1] - \gamma y[k] = f[k+1] \quad \gamma = 1 + r$$

or

$$(E - \gamma)y[k] = Ef[k]$$

The impulse response for this system is found in Prob. 3.5-8 to be

$$h[k] = \gamma^k u[k]$$

The zero-input response is

$$y_0[k] = c\gamma^k u[k]$$

Setting  $k = 0$ , and substituting  $y_0[0] = -M$ , yields  $c = -M$  and

$$y_0[k] = -M\gamma^k u[k]$$

The zero-state response  $y[k]$  is

$$y[k] = h[k] * f[k]$$

Let  $P$  be the monthly payment. The first payment is made one month after receiving the loan (at  $k = 1$ ). Therefore the input is

$$f[k] = Pu[k-1]$$

and

$$\begin{aligned} y[k] &= h[k] * Pu[k-1] \\ &= P\gamma^k u[k] * u[k-1] \end{aligned}$$

Here we use shift property of convolution. Because

$$x[k] = \gamma^k u[k] * u[k] = \left[ \frac{\gamma^{k+1} - 1}{\gamma - 1} \right] u[k]$$

The shift property yields

$$P\gamma^k u[k] + u[k-1] = z[k-1] = P\left[\frac{\gamma^k - 1}{\gamma - 1}\right]u[k-1]$$

The total balance is  $y_0[k] + y[k]$

$$y_0[k] + y[k] = -M\gamma^k u[k] + P\left[\frac{\gamma^k - 1}{\gamma - 1}\right]u[k-1]$$

For  $k > 1$ ,  $u[k] = u[k-1] = 1$ . Therefore

$$\text{Loan balance} = -M\gamma^k + P\left[\frac{\gamma^k - 1}{\gamma - 1}\right] \quad k > 1$$

Also  $\gamma = 1 + r$  and  $\gamma - 1 = r$  where  $r$  is the interest rate per dollar per month. At  $k = N$ , the loan balance is zero. Therefore

$$-M\gamma^N + P\left[\frac{\gamma^N - 1}{\gamma - 1}\right] = 0$$

or

$$P = \frac{M\gamma^N}{\gamma^N - 1}r$$

3.5-10 We use the result in Prob. 3.5-9. In this problem  $r = 0.015$ ,  $\gamma = 1.015$ ,  $P = 500$ ,  $M = 10000$ . Therefore

$$500 = 10000 \frac{(1.015)^N (0.015)}{(1.015)^N - 1}$$

or

$$\begin{aligned} (1.015)^N &= 1.42857 \\ N \ln(1.015) &= \ln(1.42857) \\ N &= \frac{\ln(1.42857)}{\ln(1.015)} = 23.956 \end{aligned}$$

Hence  $N = 23$  payments are needed. The residual balance (remainder) at the 23rd payment is

$$y[23] = -10000(1.015)^{23} + 500\left[\frac{(1.015)^{23} - 1}{0.015}\right] = -471.2$$

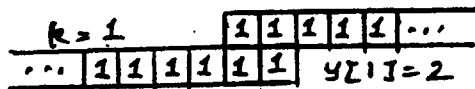
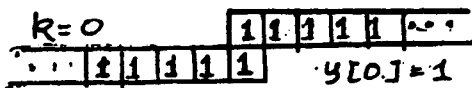

(a)

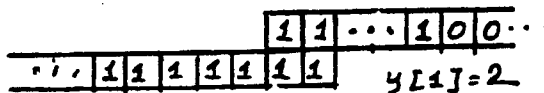
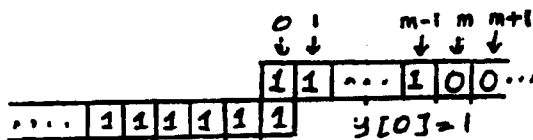
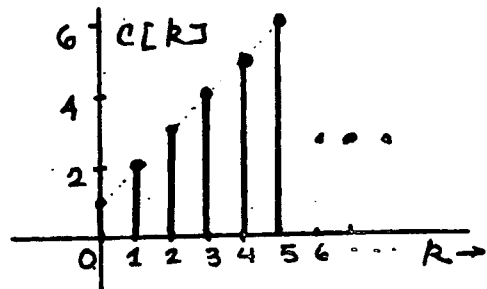

(b)

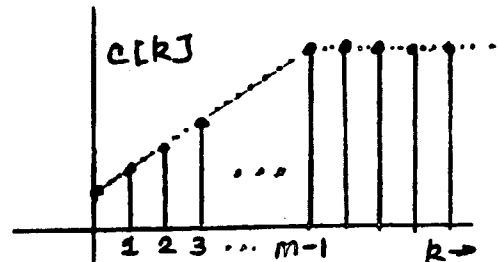

Fig. S3.5-11



3.5-11 (a) The two strips corresponding to  $u[k]$  and  $u[k]$  (after inversion) are shown in the figure S3.5-11a for no shift ( $k = 0$ ) and for one shift ( $k = 1$ ). We see that if  $c[k] = u[k] * u[k]$  then

$$c[0] = 1, \quad c[1] = 2, \quad c[2] = 3, \quad c[3] = 4, \quad c[4] = 5, \quad c[5] = 6, \dots, \quad c[k] = k + 1$$

Hence

$$u[k] * u[k] = (k + 1)u[k]$$

(b) The appropriate strips for the two functions  $u[k] - u[k - m]$  and  $u[k]$  are shown in Fig. S3.5-11b. The upper strip corresponding to  $u[k] - u[k - m]$  has first  $m$  slots with value 1 and all the remaining slots have value 0. The lower (inverted) strip corresponding to  $u[k]$  has all slot values of 1. From this figure it follows that

$$c[0] = 1, \quad c[1] = 2, \quad c[2] = 3, \dots, \quad c[m - 1] = m$$

$$c[m] = c[m + 1] = \dots = m$$

$$\text{Hence} \quad c[k] = (k + 1)u[k] - (k - m + 1)u[k - m]$$

3.5-12 From Fig. S3.5-12 we observe that

$k$	$y[k]$	
0	$0 + 1 + 2 + 3 + 4 + 5 = 15$	$y[k] = 0 \quad k \geq 6$
1	$1 + 2 + 3 + 4 + 5 = 15$	
2	$2 + 3 + 4 + 5 = 14$	$y[k] = 15 \quad k < 0$
3	$3 + 4 + 5 = 12$	
4	$4 + 5 = 9$	
5	5	
6	0	

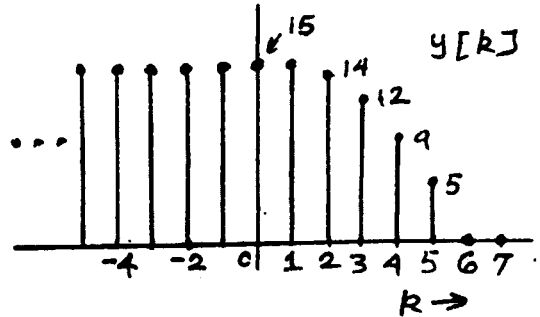
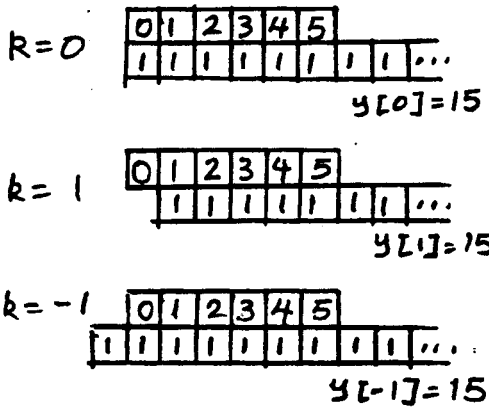

Fig. S3.5-12

3.5-13 From Fig. S3.5-13, we observe the following values for  $y[k]$ :

$k$	$y[k]$	$k$	$y[k]$
0	$5 \times 5 + 5 \times 5 = 50$	$\pm 11$	$0 \times 0 + 5 \times 4 = 20$
$\pm 1$	$5 \times 4 + 0 = 20$	$\pm 12$	$0 \times 0 + 5 \times 3 = 15$
$\pm 2$	$5 \times 3 + 0 = 15$	$\pm 13$	$0 \times 0 + 5 \times 2 = 10$
$\pm 3$	$5 \times 2 + 0 = 10$	$\pm 14$	$0 \times 0 + 5 \times 1 = 5$
$\pm 4$	$5 \times 1 + 0 = 5$	$\pm 15$	$0 \times 0 + 0 \times 0 = 0$
$\pm 5$	$5 \times 0 + 0 = 0$	$\pm 16$	0
...	...	$\pm 17$	0
$\pm 9$	$0 \times 0 + 0 \times 0 = 0$	$\pm 18$	0
$\pm 10$	$0 \times 0 + 5 \times 1 = 5$		

Observe that

$$y[k] = 0 \quad 5 \leq |k| \leq 9 \quad \text{and} \quad |k| \geq 15$$

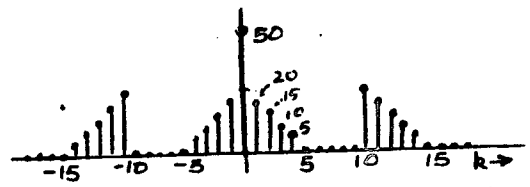
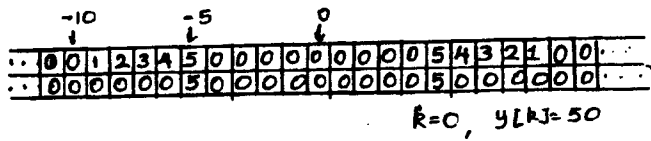

Fig. S3.5-13

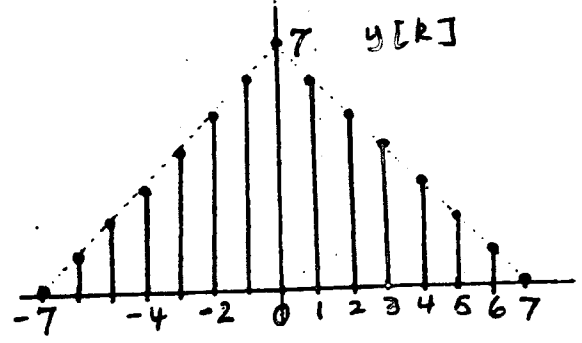
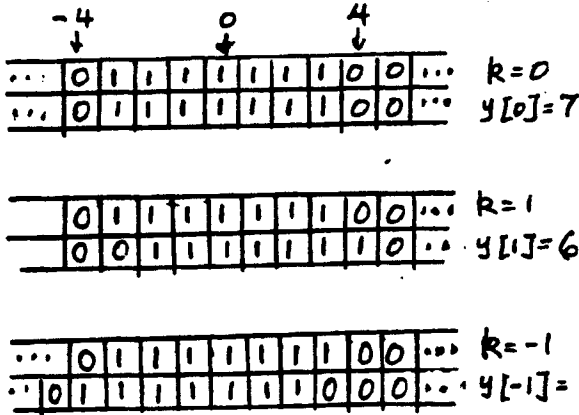

Fig. S3.5-14

3.5-14 (a) From Fig. S3.5-13, we observe the following values of  $y[k]$ :

$k$	0	$\pm 1$	$\pm 2$	$\pm 3$	$\pm 4$	$\pm 5$	$\pm 6$	$\pm 7$	$ k  > 7$
$y[k]$	7	6	5	4	3	2	1	0	0

(b) The answer is identical to that of (a). This is because when we lay the tapes  $f[m]$  and  $g[-m]$  together, the situation is identical to that in (a).

3.5.15. (a)

$$\begin{aligned}
 8 &= h[0] \\
 12 &= h[1] + h[0] \implies h[1] = 12 - 8 = 4 \\
 14 &= h[2] + h[1] + h[0] \implies h[2] = 2 \\
 15 &= h[3] + h[2] + h[1] + h[0] \implies h[3] = 1 \\
 15.5 &= h[4] + h[3] + h[2] + h[1] + h[0] \implies h[4] = 0.5 \\
 15.75 &= h[5] + h[4] + h[3] + h[2] + h[1] + h[0] \implies h[5] = 0.25
 \end{aligned}$$

(b)

$$\mathbf{H} = \begin{bmatrix} 1 & 0 & 0 \\ 2 & 1 & 0 \\ 4 & 2 & 1 \end{bmatrix} \implies \mathbf{H}^{-1} = \begin{bmatrix} 1 & 0 & 0 \\ -2 & 1 & 0 \\ 0 & -2 & 1 \end{bmatrix}$$

$$\mathbf{f} = \mathbf{H}^{-1}\mathbf{y} = \begin{bmatrix} 1 & 0 & 0 \\ -2 & 1 & 0 \\ 0 & -2 & 1 \end{bmatrix} \begin{bmatrix} 1 \\ 7/3 \\ 43/9 \end{bmatrix} = \begin{bmatrix} 1 \\ 1/3 \\ 1/9 \end{bmatrix}$$

Hence the input sequence is:  $(1, 1/3, 1/9, \dots)$

3.5-16 The appropriate array and the resulting  $c[k]$  are shown in Fig. S3-5-16

3.6-1 (a)

$$\gamma^2 + 0.6\gamma - 1.6 = (\gamma - 0.2)(\gamma + 0.8)$$

Roots are 0.2 and  $-0.8$ . Both are inside the unit circle. The system is asymptotically stable.

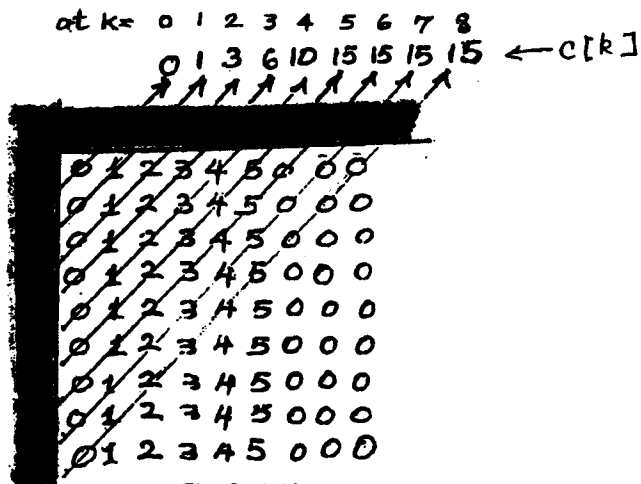

Fig. S3.5-16

(b)

$$(\gamma^2 + 1)(\gamma^2 + \gamma + 1) = (\gamma - j1)(\gamma + j1)(\gamma + \frac{1}{2} - \frac{j\sqrt{3}}{2})(\gamma + \frac{1}{2} + \frac{j\sqrt{3}}{2})$$

Roots are  $\pm j1$ ,  $-\frac{1}{2} \pm \frac{j\sqrt{3}}{2} = e^{\pm j\pi/3}$ .

All the roots are simple and on unit circle. The system is marginally stable.

(c)

$$(\gamma - 1)^2(\gamma + \frac{1}{2})$$

Roots are 1 (repeated twice) and  $-0.5$ . Repeated root on unit circle. The system is unstable.

(d)

$$\gamma^2 + 2\gamma + 0.96 = (\gamma + 0.8)(\gamma + 1.2)$$

Roots are  $-0.8$  and  $-1.2$ . One root ( $-1.2$ ) is outside the the unit circle. The system is unstable.

(e)

$$(\gamma^2 - 1)(\gamma^2 + 1) = (\gamma + 1)(\gamma - 1)(\gamma + j1)(\gamma - j1)$$

Roots are  $\pm 1$ ,  $\pm j1$ . All the roots are simple and on unit circle. The system is marginally stable.

3.6-2 Assume that a system exists that violates (3.72), and yet produces bounded output for every bounded input. The system response at  $k = k_1$  is

$$y[k_1] = \sum_{m=0}^{\infty} h[m]f[k_1 - m]$$

Consider a bounded input  $f[k]$  such that

$$f[k_1 - m] = \begin{cases} 1 & \text{if } h[m] > 0 \\ -1 & \text{if } h[m] < 0 \end{cases}$$

In this case

$$h[m]f[k_1 - m] = |h[m]|$$

and

$$y[k_1] = \sum_{m=0}^{\infty} |h[m]| = \infty$$

This violates the assumption.

3.6-3 For a marginally stable system  $h[k]$  does not decay. For large  $k$ , it is either constant or oscillates with constant amplitude. Clearly

$$\sum_{m=0}^{\infty} |h[m]| = \infty$$

The system is BIBO unstable.

## 3.8-1

$$(E + 2)y[k] = Ef[k]$$

The characteristic equation is  $\gamma + 2 = 0$ , and the characteristic root is  $-2$ . Therefore

$$y_n(t) = B(-2)^k$$

For  $f[k] = e^{-k}u[k] = r^k$  with  $r = e^{-1}$

$$\begin{aligned} y_\phi[k] &= H[e^{-1}]e^{-k} = \frac{e^{-1}}{e^{-1}+2}e^{-k} = \frac{1}{2e+1}e^{-k} \\ y[k] &= B(-2)^k + \frac{1}{2e+1}e^{-k} \quad k \geq 0 \end{aligned}$$

Setting  $k = 0$ , and substituting  $y[0] = 1$  yields

$$1 = B + \frac{1}{2e+1} \implies B = \frac{2e}{2e+1}$$

and

$$y[k] = \frac{1}{2e+1}[2e(2)^{-k} + e^{-k}] \quad k \geq 0$$

## 3.8-2

$$y[k] + 2y[k-1] = f[k-1] \quad (1)$$

We solve this equation iteratively to obtain  $y[0]$ . Setting  $k = 0$ , and substituting  $y[-1] = 0$ ,  $f[-1] = 0$ , we get

$$y[0] + 2(0) = 0 \implies y[0] = 0$$

The system equation can be expressed as

$$(E + 2)y[k] = f[k]$$

The characteristic root is  $-2$ . Therefore

$$y_n[k] = B(-2)^k$$

For  $f[k] = e^{-k}u[k] = r^k$  with  $r = e^{-1}$ ,

$$y_\phi[k] = H[r]r^k = H[e^{-1}]e^{-k} = \frac{e^{-1}}{e^{-1}+2}e^{-k} = \frac{e}{2e+1}e^{-k}$$

Therefore

$$y[k] = B(-2)^k + \frac{e}{2e+1}e^{-k} \quad k \geq 0$$

Setting  $k = 0$  and substituting  $y[0] = 0$  yields

$$0 = B + \frac{e}{2e+1} \implies B = \frac{-e}{2e+1}$$

and

$$y[k] = \frac{-e}{2e+1}[(-2)^k + e^{-k}] \quad k \geq 0$$

## 3.8-3

$$(E^2 + 3E + 2)y[k] = (E^2 + 3E + 3)f[k]$$

The characteristic equation is  $\gamma^2 + 3\gamma + 2 = (\gamma + 1)(\gamma + 2) = 0$ . Therefore

$$y_n[k] = B_1(-1)^k + B_2(-2)^k$$

For  $f[k] = 3^k$

$$y_\phi[k] = H[3]3^k = \frac{(3)^2 + 3(3) + 3}{(3)^2 + 3(3) + 2}3^k = \left(\frac{21}{13}\right)3^k$$

The total response

$$y[k] = B_1(-1)^k + B_2(-2)^k + \left(\frac{21}{13}\right)3^k \quad k \geq 0$$

(a) Setting  $k = 0, 1$ , and substituting  $y[0] = 1$ ,  $y[1] = 3$ , yields

$$\left. \begin{aligned} 1 &= B_1 + B_2 + \frac{21}{20} \\ 3 &= -B_1 - 2B_2 + \frac{63}{20} \end{aligned} \right\} \Rightarrow \begin{aligned} B_1 &= -\frac{1}{4} \\ B_2 &= \frac{1}{5} \end{aligned}$$

$$y[k] = -\frac{1}{4}(-1)^k + \frac{1}{5}(-2)^k + \frac{21}{20}(3)^k \quad k \geq 0$$

(b) We solve system equation iteratively to find  $y[0]$  and  $y[1]$ . We are given  $y[-1] = y[-2] = 1$ . System equation is

$$y[k+2] + 3y[k+1] + 2y[k] = f[k+2] + 3f[k+1] + 3f[k]$$

Setting  $k = -2$ , we obtain

$$y[0] + 3(1) + 2(1) = (3)^0 + 3(0) + 3(0) \Rightarrow y[0] = -4$$

Setting  $k = -1$ , we obtain

$$y[1] + 3[-4] + 2(1) = (3)^1 + 3(3)^0 + 3(0) \Rightarrow y[1] = 16$$

Also

$$y[k] = B_1(-1)^k + B_2(-2)^k + \frac{21}{20}(3)^k \quad k \geq 0$$

Setting  $k = 1, 2$ , and substituting  $y[0] = -4, y[1] = 16$ , yields

$$\left. \begin{aligned} -4 &= B_1 + B_2 + \frac{21}{20} \\ 16 &= -B_1 - 2B_2 + \frac{63}{20} \end{aligned} \right\} \Rightarrow \begin{aligned} B_1 &= \frac{11}{4} \\ B_2 &= -\frac{39}{5} \end{aligned}$$

and

$$y[k] = \frac{11}{4}(-1)^k - \frac{39}{5}(-2)^k + \frac{21}{20}(3)^k \quad k \geq 0$$

3.8-4

$$\gamma^2 + 2\gamma + 1 = (\gamma + 1)^2 = 0$$

The roots are  $-1$  repeated twice.

$$y_n[k] = (B_1 + B_2 k)(-1)^k$$

Also the system equation is  $(E^2 + 2E + 1)y[k] = (2E^2 - E)f[k]$ , and  $f[k] = (\frac{1}{3})^k$ . Therefore

$$y_\phi[k] = H[\frac{1}{3}]3^{-k} = -\frac{1}{18}(3)^{-k} \quad k \geq 0$$

The total response

$$y[k] = (B_1 + B_2 k)(-1)^k - \frac{1}{18}(3)^{-k} \quad k \geq 0$$

Setting  $k = 0, 1$ , and substituting  $y[0] = 2, y[1] = -\frac{13}{3}$ , yields

$$\left. \begin{aligned} 2 &= B_1 - \frac{1}{18} \\ -\frac{13}{3} &= -(B_1 + B_2) - \frac{1}{18} \end{aligned} \right\} \Rightarrow \begin{aligned} B_1 &= \frac{35}{18} \\ B_2 &= \frac{2}{3} \end{aligned}$$

$$y[k] = (\frac{35}{18} + \frac{2}{3}k)(-1)^k - \frac{1}{18}(3)^{-k} \quad k \geq 0$$

3.8-5

$$\gamma^2 - \gamma + 0.16 = (\gamma - 0.2)(\gamma - 0.8)$$

The roots are 0.2 and 0.8.

$$y_n[k] = B_1(0.2)^k + B_2(0.8)^k$$

Because the input is a mode

$$y_\phi[k] = ck(0.2)^k$$

But  $y_\phi[k]$  satisfies the system equation, that is,

$$y_\phi[k+2] - y_\phi[k+1] + 0.16y_\phi[k] = f[k+1]$$

and

$$c(k+2)(0.2)^{k+2} - c(k+1)(0.2)^{k+1} + 0.16ck(0.2)^k = (0.2)^{k+1}$$

This yields

$$-0.12c(0.2)^k = 0.2(0.2)^k$$

Therefore

$$c = -\frac{1}{3}$$

and

$$y_\phi[k] = -\frac{1}{3}k(0.2)^k$$

$$y[k] = B_1(0.2)^k + B_2(0.8)^k - \frac{1}{3}k(0.2)^k \quad k \geq 0$$

Setting  $k = 0, 1$ , and substituting initial conditions  $y[0] = 1, y[1] = 2$ , yields

$$\left. \begin{aligned} 1 &= B_1 + B_2 \\ 2 &= 0.2B_1 + 0.8B_2 - \frac{1}{3} \end{aligned} \right\} \implies \begin{aligned} B_1 &= -\frac{22}{9} \\ B_2 &= \frac{32}{9} \end{aligned}$$

$$y[k] = -\frac{22}{9}(0.2)^k + \frac{32}{9}(0.8)^k - \frac{1}{3}k(0.2)^k \quad k \geq 0$$

3.8-6

$$y[k+2] - y[k+1] + 0.16y[k] = f[k+1]$$

We solve this equation iteratively for  $f[k] = \cos(\frac{\pi k}{2} + \frac{\pi}{3})$ ,  $y[-1] = y[-2] = 0$ , to find  $y[0]$  and  $y[1]$ . Remember also that  $f[k] = 0$  for  $k < 0$ .

Setting  $k = -2$  in the equation yields

$$y[0] - 0 + 0.16(0) = 0 \implies y[0] = 0$$

Setting  $k = -1$  in the equation yields

$$y[1] - 0 + 0.16(0) = \cos \frac{\pi}{3} = 0.5 \implies y[1] = 0.5$$

Therefore  $y[0] = 0$  and  $y[1] = 0.5$ . For the input  $f[k] = \cos(\frac{\pi k}{2} + \frac{\pi}{3})$ .

$$y_\phi[k] = c \cos(\frac{\pi k}{2} + \frac{\pi}{3} + \phi)$$

But  $y_\phi[k]$  satisfies the system equation, that is,

$$y_\phi[k+2] - y_\phi[k+1] + 0.16y_\phi[k] = f[k+1]$$

or

$$c \cos[\frac{\pi}{2}(k+2) + \frac{\pi}{3} + \phi] - c \cos[\frac{\pi}{2}(k+1) + \frac{\pi}{3} + \phi] + 0.16c \cos(\frac{\pi k}{2} + \frac{\pi}{3} + \phi) = \cos[\frac{\pi}{2}(k+1) + \frac{\pi}{3}]$$

or

$$-c \cos(\frac{\pi k}{2} + \frac{\pi}{3} + \phi) + c \sin(\frac{\pi k}{2} + \frac{\pi}{3} + \phi) + 0.16c \cos(\frac{\pi k}{2} + \frac{\pi}{3} + \phi) = \cos(\frac{\pi k}{2} + \frac{\pi}{3} + \frac{\pi}{2})$$

or

$$1.306c \cos(\frac{\pi k}{2} + \frac{\pi}{3} + \phi - 2.27) = \cos(\frac{\pi k}{2} + \frac{\pi}{3} + \frac{\pi}{2})$$

Therefore

$$\begin{aligned} 1.306c &= 1 \implies c = 0.765 \\ \phi - 2.27 &= \frac{\pi}{2} \implies \phi = 3.84 = -2.44 \text{rad} \end{aligned}$$

Therefore

$$\begin{aligned} y_\phi[k] &= 0.765 \cos(\frac{\pi k}{2} + \frac{\pi}{3} - 2.44) \\ &= 0.765 \cos(\frac{\pi k}{2} - 1.393) \end{aligned}$$

$$y[k] = B_1(0.2)^k + B_2(0.8)^k + 0.765 \cos(\frac{\pi k}{2} - 1.393)$$

Setting  $k = 0, 1$ , and substituting  $y[0] = 0, y[1] = 0.5$ , yields

$$\left. \begin{aligned} 0 &= B_1 + B_2 + 0.1354 \\ 0.5 &= 0.2B_1 + 0.8B_2 + 0.753 \end{aligned} \right\} \implies \begin{aligned} B_1 &= 0.241 \\ B_2 &= -0.377 \end{aligned}$$

$$y[k] = 0.241(0.2)^k - 0.377(0.8)^k + 0.765 \cos(\frac{\pi k}{2} - 1.393)$$



## Chapter 4

4.1-1 (a)

$$f(t) = u(t) - u(t-1)$$

$$\begin{aligned} F(s) &= \int_0^1 e^{-st} dt = -\frac{e^{-st}}{s} \Big|_0^1 \\ &= -\frac{1}{s}[e^{-s} - 1] \\ &= \frac{1}{s}[1 - e^{-s}] \end{aligned}$$

Note that the result is valid for all values of  $s$ ; hence the region of convergence is the entire  $s$ -plane. The abscissa of convergence is  $\sigma_0 = -\infty$ .

(b)

$$f(t) = te^{-t}u(t)$$

$$\begin{aligned} F(s) &= \int_0^{\infty} te^{-t}e^{-st} dt = \int_0^{\infty} te^{-(s+1)t} dt \\ &= -\frac{e^{-(s+1)t}}{(s+1)^2} [-(s+1)t - 1] \Big|_0^{\infty} \\ &= \frac{1}{(s+1)^2} \end{aligned}$$

provided that  $e^{-(s+1)\infty} = 0$  or  $\text{Re}(s+1) > 0$ . Hence the abscissa of convergence is  $\text{Re}(s) > -1$  or  $\sigma_0 > -1$ .

(c)

$$f(t) = t \cos \omega_0 t u(t)$$

$$\begin{aligned} F(s) &= \int_0^{\infty} t \cos \omega_0 t e^{-st} dt \\ &= \frac{1}{2} \left\{ \int_0^{\infty} [te^{(j\omega_0 - s)t} + te^{-(j\omega_0 + s)t}] dt \right\} \\ &= \frac{1}{2} \left[ \frac{1}{(s - j\omega_0)^2} + \frac{1}{(s + j\omega_0)^2} \right] \quad \text{Re}(s) > 0 \\ &= \frac{s^2 - \omega_0^2}{(s^2 + \omega_0^2)^2} \end{aligned}$$

(d)

$$f(t) = (e^{2t} - 2e^{-t})u(t)$$

$$\begin{aligned} F(s) &= \int_0^{\infty} (e^{2t} - 2e^{-t})e^{-st} dt \\ &= \int_0^{\infty} e^{2t}e^{-st} dt - 2 \int_0^{\infty} e^{-t}e^{-st} dt \\ &= \int_0^{\infty} e^{-(s-2)t} dt - 2 \int_0^{\infty} e^{-(s+1)t} dt \\ &= \frac{1}{s-2} - \frac{2}{s+1} \end{aligned}$$

We get the first term only if  $\text{Re } s > 2$ , and we get the second term only if  $\text{Re } (s) > -1$ . Both conditions will be satisfied if  $\text{Re } (s) > 2$  or  $\sigma_0 > 2$ . Hence:

$$F(s) = \frac{1}{s-2} - \frac{2}{s+1} \quad \text{for } \sigma_0 > 2$$

(e)

$$f(t) = \cos \omega_1 t \cos \omega_2 t u(t) = \left[ \frac{1}{2} \cos(\omega_1 + \omega_2)t + \frac{1}{2} \cos(\omega_1 - \omega_2)t \right] u(t)$$

$$\begin{aligned} F(s) &= \frac{1}{2} \int_0^{\infty} \cos(\omega_1 + \omega_2)t e^{-st} dt + \frac{1}{2} \int_0^{\infty} \cos(\omega_1 - \omega_2)t e^{-st} dt \\ &= \frac{1}{2} \left[ \frac{s}{s^2 + (\omega_1 + \omega_2)^2} + \frac{s}{s^2 + (\omega_1 - \omega_2)^2} \right] \end{aligned}$$

provided that  $\text{Re } (s) > 0$ .

(f)

$$f(t) = \cosh(at)u(t)$$

$$\begin{aligned} F(s) &= \frac{1}{2} \left[ \int_0^{\infty} e^{at} e^{-st} dt + \int_0^{\infty} e^{-at} e^{-st} dt \right] \\ &= \frac{1}{2} \left[ \int_0^{\infty} e^{-(s-a)t} dt + \int_0^{\infty} e^{-(s+a)t} dt \right] \\ &= \frac{s}{s^2 - a^2} \quad \text{Re } s > |a| \end{aligned}$$

(g)

$$f(t) = \sinh(at)u(t)$$

$$\begin{aligned} F(s) &= \frac{1}{2} \left[ \int_0^{\infty} e^{-(s-a)t} dt - \int_0^{\infty} e^{-(s+a)t} dt \right] \\ &= \frac{a}{s^2 - a^2} \quad \text{Re } s > |a| \end{aligned}$$

(h)

$$\begin{aligned} f(t) &= e^{-2t} \cos(5t + \theta)u(t) \\ &= \frac{1}{2} \left[ e^{-2t+j(5t+\theta)} + e^{-2t-j(5t+\theta)} \right] \\ &= \frac{1}{2} e^{j\theta} e^{-(2-j5)t} + \frac{1}{2} e^{-j\theta} e^{-(2+j5)t} \end{aligned}$$

$$\text{Hence } F(s) = \frac{1}{2} e^{j\theta} \left( \frac{1}{s+2-j5} \right) + \frac{1}{2} e^{-j\theta} \left( \frac{1}{s+2+j5} \right)$$

This is valid if  $\text{Re } (s) > -2$  for both terms; hence

$$F(s) = \frac{(s+2) \cos \theta - 5 \sin \theta}{s^2 + 4s + 29}$$

4.1-2 (a)

$$F(s) = \int_0^1 t e^{-st} dt = \left. \frac{e^{-st}}{s} (-st - 1) \right|_0^1 = \frac{1}{s^2} (1 - e^{-s} - se^{-s})$$

(b)

$$F(s) = \int_0^{\pi} \sin t e^{-st} dt = \left. \frac{e^{-st}}{s^2 + 1} (-s \sin t - \cos t) \right|_0^{\pi} = \frac{1 + e^{-\pi s}}{s^2 + 1}$$

(c)

$$\begin{aligned}
F(s) &= \int_0^1 \frac{1}{e} e^{-st} dt + \int_1^{\infty} e^{-t} e^{-st} dt = \frac{1}{e} \int_0^1 t e^{-st} dt + \int_1^{\infty} e^{-(s+1)t} dt \\
&= \frac{e^{-st}}{es} (-st - 1) \Big|_0^1 - \frac{1}{s+1} e^{-(s+1)t} \Big|_1^{\infty} \\
&= \frac{1}{es^2} (1 - e^{-s} - se^{-s}) + \frac{1}{s+1} e^{-(s+1)}
\end{aligned}$$

4.1-3 (a)

$$\begin{aligned}
F(s) &= \frac{2s+5}{s^2+5s+6} = \frac{2s+5}{(s+2)(s+3)} = \frac{1}{s+2} + \frac{1}{s+3} \\
f(t) &= (e^{-2t} + e^{-3t})u(t)
\end{aligned}$$

(b)

$$F(s) = \frac{3s+5}{s^2+4s+13}$$

Here  $A = 3$ ,  $B = 5$ ,  $a = 2$ ,  $c = 13$ ,  $b = \sqrt{13-4} = 3$ .

$$r = \sqrt{\frac{117+23-40}{13-4}} = 3.018 \quad \theta = \tan^{-1}\left(\frac{1}{3}\right) = 6.34^\circ$$

$$f(t) = 3.018e^{-2t} \cos(3t + 6.34^\circ)u(t)$$

(c)

$$F(s) = \frac{(s+1)^2}{s^2-s-6} = \frac{(s+1)^2}{(s+2)(s-3)}$$

This is an improper fraction with  $b_0 = b_2 = 1$ . Therefore

$$\begin{aligned}
F(s) &= 1 + \frac{a}{s+2} + \frac{b}{s-3} = 1 - \frac{0.2}{s+2} + \frac{3.2}{s-3} \\
f(t) &= \delta(t) + (3.2e^{3t} - 0.2e^{-2t})u(t)
\end{aligned}$$

(d)

$$F(s) = \frac{5}{s^2(s+2)} = \frac{k}{s} + \frac{2.5}{s^2} + \frac{1.25}{s+2}$$

To find  $k$  set  $s = 1$  on both sides to obtain

$$\frac{5}{3} = k + 2.5 + \frac{1}{3} \implies k = -1.25$$

and

$$\begin{aligned}
F(s) &= -\frac{1.25}{s} + \frac{2.5}{s^2} + \frac{1.25}{s+2} \\
f(t) &= 1.25(-1 + 2t + e^{-2t})u(t)
\end{aligned}$$

(e)

$$F(s) = \frac{2s+1}{(s+1)(s^2+2s+2)} = \frac{-1}{s+1} + \frac{As+B}{s^2+2s+2}$$

Multiply both sides by  $s$  and let  $s \rightarrow \infty$ . This yields

$$0 = -1 + A \implies A = 1$$

Setting  $s = 0$  on both sides yields

$$\frac{1}{2} = -1 + \frac{B}{2} \implies B = 3$$

$$F(s) = -\frac{1}{s+1} + \frac{s+3}{s^2+2s+2}$$

In the second fraction,  $A = 1$ ,  $B = 3$ ,  $a = 1$ ,  $c = 2$ ,  $b = \sqrt{2-1} = 1$ .

$$r = \sqrt{\frac{2+2-1}{2-1}} = \sqrt{5} \quad \theta = \tan^{-1}\left(\frac{2}{1}\right) = -63.4^\circ$$

$$f(t) = [-e^{-t} + \sqrt{5}e^{-t} \cos(t - 63.4^\circ)]u(t)$$

(f)

$$F(s) = \frac{s+2}{s(s+1)^2} = \frac{2}{s} + \frac{k}{s+1} - \frac{1}{(s+1)^2}$$

To compute  $k$ , multiply both sides by  $s$  and let  $s \rightarrow \infty$ . This yields

$$0 = 2 + k + 0 \implies k = -2$$

and

$$F(s) = \frac{2}{s} - \frac{2}{s+1} - \frac{1}{(s+1)^2}$$

$$f(t) = [2 - (2+t)e^{-t}]u(t)$$

(g)

$$F(s) = \frac{1}{(s+1)(s+2)^4} = \frac{1}{s+1} + \frac{k_1}{s+2} + \frac{k_2}{(s+2)^2} + \frac{k_3}{(s+2)^3} - \frac{1}{(s+2)^4}$$

Multiplying both sides by  $s$  and let  $s \rightarrow \infty$ . This yields

$$0 = 1 + k_1 \implies k_1 = -1$$

$$\frac{1}{(s+1)(s+2)^4} = \frac{1}{s+1} - \frac{1}{s+2} + \frac{k_2}{(s+2)^2} + \frac{k_3}{(s+2)^3} - \frac{1}{(s+2)^4}$$

Setting  $s = 0$  and  $-3$  on both sides yields

$$\begin{aligned} \frac{1}{16} &= 1 - \frac{1}{2} + \frac{k_2}{4} + \frac{k_3}{8} - \frac{1}{16} \implies 4k_2 + 2k_3 = -6 \\ -\frac{1}{2} &= -\frac{1}{2} + 1 + k_2 - k_3 - 1 \implies k_2 - k_3 = 0 \end{aligned}$$

Solving these two equations simultaneously yields  $k_2 = k_3 = -1$ . Therefore

$$F(s) = \frac{1}{s+1} - \frac{1}{s+2} - \frac{1}{(s+2)^2} - \frac{1}{(s+2)^3} - \frac{1}{(s+2)^4}$$

$$f(t) = [e^{-t} - (1+t + \frac{t^2}{2} + \frac{t^3}{6})e^{-2t}]u(t)$$

Comment: This problem could be tackled in many ways. We could have used Eq. (B.64b), or after determining first two coefficients by Heaviside method, we could have cleared fractions. Also instead of letting  $s = 0$  and  $-3$ , we could have selected any other set of values. However, in this case these values appear most suitable for numerical work.

(h)

$$F(s) = \frac{s+1}{s(s+2)^2(s^2+4s+5)} = \frac{(1/20)}{s} + \frac{k}{s+2} + \frac{(1/2)}{(s+2)^2} + \frac{As+B}{s^2+4s+5}$$

Multiplying both sides by  $s$  and let  $s \rightarrow \infty$  yields

$$0 = \frac{1}{20} + k + A \implies k + A = -\frac{1}{20}$$

Setting  $s = 1$  and  $-1$  yields

$$\begin{aligned} \frac{2}{90} &= \frac{1}{20} + \frac{k}{3} + \frac{1}{16} + \frac{A+B}{10} \implies 20k + 6A + 6B = -5 \\ 0 &= -\frac{1}{20} + k + \frac{1}{2} + \frac{-A+B}{2} \implies 20k - 10A + 10B = -9 \end{aligned}$$

Solving these three equations in  $k$ ,  $A$  and  $B$  yields  $k = -\frac{1}{4}$ ,  $A = \frac{1}{5}$  and  $B = -\frac{1}{5}$ . Therefore

$$F(s) = \frac{1/20}{s} - \frac{1/4}{s+2} + \frac{(1/2)}{(s+2)^2} + \frac{1}{5} \left( \frac{s-1}{s^2+4s+5} \right)$$

For the last fraction in parenthesis on the right-hand side  $A = 1$ ,  $B = -1$ ,  $a = 2$ ,  $c = 5$ ,  $b = \sqrt{5-4} = 1$ .

$$r = \sqrt{\frac{4+1+1}{5-1}} = \sqrt{10} \quad \theta = \tan^{-1}\left(\frac{1}{2}\right) = 71.56^\circ$$

$$f(t) = \left[ \frac{1}{20} - \frac{1}{4}(1-2t)e^{-2t} + \frac{\sqrt{10}}{5}e^{-2t} \cos(t+71.56^\circ) \right] u(t)$$

(i)

$$F(s) = \frac{s^3}{(s+1)^2(s^2+2s+5)} = \frac{k}{s+1} - \frac{1/4}{(s+1)^2} + \frac{As+B}{s^2+2s+5}$$

Multiply both sides by  $s$  and let  $s \rightarrow \infty$  to obtain

$$1 = k + A$$

Setting  $s = 0$  and  $1$  yields

$$\begin{aligned} 0 &= k - \frac{1}{4} + \frac{A}{5} \implies 20k + 4B = 5 \\ \frac{1}{32} &= \frac{k}{2} - \frac{1}{16} + \frac{A+2B}{4} \implies 16k + 4A + 4B = 3 \end{aligned}$$

Solving these three equations in  $k$ ,  $A$  and  $B$  yields  $k = \frac{3}{4}$ ,  $A = \frac{1}{4}$  and  $B = -\frac{1}{2}$ .

$$F(s) = \frac{3/4}{s+1} - \frac{1/4}{(s+1)^2} + \frac{1}{4} \left( \frac{s-10}{s^2+2s+5} \right)$$

For the last fraction in parenthesis,  $A = 1$ ,  $B = -10$ ,  $a = 1$ ,  $c = 5$ ,  $b = \sqrt{5-1} = 2$ .

$$r = \sqrt{\frac{1+100+20}{5-1}} = 5.59 \quad \theta = \tan^{-1}\left(\frac{11}{4}\right) = 70^\circ$$

Therefore

$$\begin{aligned} f(t) &= \left[ \left( \frac{3}{4} - \frac{1}{4}t \right) e^{-t} + \frac{1+22}{4} e^{-t} \cos(2t+70^\circ) \right] u(t) \\ &= \left[ \frac{1}{4}(3-t) + 1.3975 \cos(2t+70^\circ) \right] e^{-t} u(t) \end{aligned}$$

4.2-1 (a)

$$f(t) = u(t) - u(t-1)$$

and

$$\begin{aligned} F(s) &= \mathcal{L}\{u(t)\} - \mathcal{L}\{u(t-1)\} \\ &= \frac{1}{s} - e^{-s} \frac{1}{s} \\ &= \frac{1}{s}(1 - e^{-s}) \end{aligned}$$

(b)

$$f(t) = e^{-(t-\tau)} u(t-\tau)$$

$$F(s) = \frac{1}{s+1} e^{-s\tau}$$

(c)

$$f(t) = e^{-(t-\tau)} u(t) = e^\tau e^{-t} u(t)$$

$$\text{Therefore } F(s) = e^\tau \frac{1}{s+1}$$

(d)

$$f(t) = e^{-t} u(t-\tau) = e^{-\tau} e^{-(t-\tau)} u(t-\tau)$$

Observe that  $e^{-(t-\tau)} u(t-\tau)$  is  $e^{-t} u(t)$  delayed by  $\tau$ . Therefore

$$F(s) = e^{-\tau} \left( \frac{1}{s+1} \right) e^{-s\tau} = \left( \frac{1}{s+1} \right) e^{-(s+1)\tau}$$



(e)

$$f(t) = te^{-t}u(t-r) = (t-r+r)e^{-(t-r+r)}u(t-r) \\ = e^{-r}[(t-r)e^{-(t-r)}u(t-r) + re^{-(t-r)}u(t-r)]$$

Therefore

$$F(s) = e^{-r} \left[ \frac{1}{(s+1)^2} e^{-sr} + \frac{r}{(s+1)} e^{-sr} \right] \\ = \frac{e^{-(s+1)r} [1 + r(s+1)]}{(s+1)^2}$$

(f)

$$f(t) = \sin \omega_0(t-r)u(t-r)$$

Note that this is  $\sin \omega_0 t$  shifted by  $r$ ; hence

$$F(s) = \left( \frac{\omega_0}{s^2 + \omega_0^2} \right) e^{-sr}$$

(g)

$$f(t) = \sin \omega_0(t-r)u(t) = [\sin \omega_0 t \cos \omega_0 r - \cos \omega_0 t \sin \omega_0 r]u(t)$$

$$F(s) = \frac{\omega_0 \cos \omega_0 r - s \sin \omega_0 r}{s^2 + \omega_0^2}$$

(h)

$$f(t) = \sin \omega_0 t u(t-r) = \sin[\omega_0(t-r+r)]u(t-r) \\ = \cos \omega_0 r \sin[\omega_0(t-r)]u(t-r) + \sin \omega_0 r \cos[\omega_0(t-r)]u(t-r)$$

Therefore

$$F(s) = \left[ \cos \omega_0 r \left( \frac{\omega_0}{s^2 + \omega_0^2} \right) + \sin \omega_0 r \left( \frac{s}{s^2 + \omega_0^2} \right) \right] e^{-sr}$$

4.2-2 (a)

$$f(t) = t[u(t) - u(t-1)] = tu(t) - (t-1)u(t-1) - u(t-1)$$

$$F(s) = \frac{1}{s^2} - \frac{1}{s^2} e^{-s} - \frac{1}{s} e^{-s}$$

(b)

$$f(t) = \sin t u(t) + \sin(t-\pi) u(t-\pi)$$

$$F(s) = \frac{1}{s^2 + 1} (1 + e^{-\pi s})$$

(c)

$$f(t) = t[u(t) - u(t-1)] + e^{-t}u(t-1) \\ = tu(t) - (t-1)u(t-1) - u(t-1) + e^{-1}e^{-(t-1)}u(t-1)$$

Therefore

$$F(s) = \frac{1}{s^2} (1 - e^{-s} - se^{-s}) + \frac{e^{-s}}{e(s+1)}$$

4.2-3 (a)

$$F(s) = \frac{(2s+5)e^{-2s}}{s^2 + 5s + 6} = F(s)e^{-2s}$$

It is clear that  $f(t) = f(t-2)$ .

$$\hat{f}(s) = \frac{2s+5}{s^2+5s+6} = \frac{2s+5}{(s+2)(s+3)} = \frac{1}{s+2} + \frac{1}{s+3}$$

$$\hat{f}(t) = (e^{-2t} + e^{-3t})u(t)$$

$$f(t) = \hat{f}(t-2) = [e^{-2(t-2)} + e^{-3(t-2)}]u(t-2)$$

(b)

$$F(s) = \frac{s}{s^2+2s+2}e^{-3s} + \frac{2}{s^2+2s+2} = F_1(s)e^{-3s} + F_2(s)$$

where

$$F_1(s) = \frac{s}{s^2+2s+2} \quad \left\{ \begin{array}{l} A=1, B=0, a=1, c=2, b=1 \\ r=\sqrt{2}, \theta = \tan^{-1}(1) = \pi/4 \end{array} \right.$$

$$f_1(t) = \sqrt{2}e^{-t} \cos(t + \frac{\pi}{4})$$

$$F_2(s) = \frac{2}{s^2+2s+2} \quad \text{and} \quad f_2(t) = 2e^{-t} \sin t$$

Also

$$f(t) = f_1(t-3) + f_2(t)$$

$$= \sqrt{2}e^{-(t-3)} \cos(t-3 + \frac{\pi}{4})u(t-3) + 2e^{-t} \sin t u(t)$$

(c)

$$F(s) = \frac{(e)e^{-s}}{s^2-2s+5} + \frac{3}{s^2-2s+5}$$

$$= e \frac{1}{s^2-2s+5} e^{-s} + \frac{3}{s^2-2s+5}$$

$$= eF_1(s)e^{-s} + F_2(s)$$

where

$$F_1(s) = \frac{1}{s^2-2s+2} \quad \text{and} \quad f_1(t) = \frac{1}{2}e^t \sin 2t u(t)$$

$$F_2(s) = \frac{3}{s^2-2s+2} \quad \text{and} \quad f_2(t) = \frac{3}{2}e^t \sin 2t u(t)$$

Therefore

$$f(t) = e f_1(t-1) + f_2(t)$$

$$= \frac{e}{2}e^{(t-1)} \sin 2(t-1)u(t-1) + \frac{3}{2}e^t \sin 2t u(t)$$

(d)

$$F(s) = \frac{e^{-s} + e^{-2s} + 1}{s^2+3s+2} = (e^{-s} + e^{-2s} + 1) \left[ \frac{1}{s^2+3s+2} \right]$$

$$= (e^{-s} + e^{-2s} + 1) \left[ \frac{1}{s+1} - \frac{1}{s+2} \right]$$

$$F(s) = (e^{-s} + e^{-2s} + 1)\hat{F}(s)$$

where

$$\hat{F}(s) = \frac{1}{s+1} - \frac{1}{s+2} \quad \text{and} \quad \hat{f}(t) = (e^{-t} - e^{-2t})u(t)$$

Moreover

$$f(t) = \hat{f}(t-1) + \hat{f}(t-2) + \hat{f}(t)$$

$$= [e^{-(t-1)} - e^{-2(t-1)}]u(t-1) + [e^{-(t-2)} - e^{-2(t-2)}]u(t-2) + (e^{-t} - e^{-2t})u(t)$$

4.2-4 (a)

and

$$g(t) = f(t) + f(t - T_0) + f(t - 2T_0) + \dots$$

$$\begin{aligned} G(s) &= F(s) + F(s)e^{-sT_0} + F(s)e^{-2sT_0} + \dots \\ &= F(s)[1 + e^{-sT_0} + e^{-2sT_0} + e^{-3sT_0} + \dots] \\ &= \frac{F(s)}{1 - e^{-sT_0}} \quad |e^{-sT_0}| < 1 \text{ or } \operatorname{Re} s > 0 \end{aligned}$$

(b)

$$\begin{aligned} f(t) &= u(t) - u(t - 2) \quad \text{and} \quad F(s) = \frac{1}{s}(1 - e^{-2s}) \\ G(s) &= \frac{F(s)}{1 - e^{-2s}} = \frac{1}{s} \left( \frac{1 - e^{-2s}}{1 - e^{-2s}} \right) \end{aligned}$$

4.2-5 Pair 2

$$u(t) = \int_{0^-}^t \delta(\tau) d\tau \iff \frac{1}{s}(1) = \frac{1}{s}$$

Pair 3

$$tu(t) = \int_{0^-}^t u(\tau) d\tau \iff \frac{1}{s} \left( \frac{1}{s} \right) = \frac{1}{s^2}$$

Pair 4: Use successive integration of  $tu(t)$

Pair 5: From frequency-shifting (4.23), we have

$$u(t) \iff \frac{1}{s} \quad \text{and} \quad e^{\lambda t} u(t) \iff \frac{1}{s - \lambda}$$

Pair 6: Because

$$tu(t) \iff \frac{1}{s^2} \quad \text{and} \quad te^{\lambda t} u(t) \iff \frac{1}{(s - \lambda)^2}$$

Pair 7: Apply the same argument to  $t^2 u(t)$ ,  $t^3 u(t)$ , ..., and so on.

Pair 8a:

$$\cos bt u(t) = \frac{1}{2}(e^{jbt} + e^{-jbt})u(t) \iff \frac{1}{2} \left( \frac{1}{s - jb} + \frac{1}{s + jb} \right) = \frac{s}{s^2 + b^2}$$

Pair 8b: Same way as the pair 8a.

Pair 9a: Application of the frequency-shift property (4.23) to pair 8a  $\cos bt u(t) \iff \frac{s}{s^2 + b^2}$  yields

$$e^{-at} \cos bt u(t) \iff \frac{s + a}{(s + a)^2 + b^2}$$

Pair 9b: Similar to the pair 9a.

Pairs 10a and 10b: Recognize that

$$re^{-at} \cos(bt + \theta) = re^{-at} [\cos \theta \cos bt - \sin \theta \sin bt]$$

Now use results in pairs 9a and 9b to obtain pair 10a. Pair 10b is equivalent to pair 10a.

4.2-6 (a) (i)

$$\begin{aligned} \frac{df}{dt} &= \delta(t) - \delta(t - 2) \\ sF(s) &= 1 - e^{-2s} \\ F(s) &= \frac{1}{s}(1 - e^{-2s}) \end{aligned}$$

(ii)

$$\begin{aligned} \frac{df}{dt} &= \delta(t - 2) - \delta(t - 4) \\ sF(s) &= e^{-2s} - e^{-4s} \\ F(s) &= \frac{1}{s}(e^{-2s} - e^{-4s}) \end{aligned}$$

(b)

$$\frac{df}{dt} = u(t) - 3u(t-2) + 2u(t-3)$$

$$sF(s) = \frac{1}{s} - \frac{3}{s}e^{-2s} + \frac{2}{s}e^{-3s} \quad [f(0^-) = 0]$$

$$F(s) = \frac{1}{s^2}(1 - 3e^{-2s} + 2e^{-3s})$$

4.3-1 (a)

$$(s^2 + 3s + 2)Y(s) = s\left(\frac{1}{s}\right)$$

$$Y(s) = \frac{1}{s^2 + 3s + 2} = \frac{1}{s+1} - \frac{1}{s+2}$$

$$y(t) = (e^{-t} - e^{-2t})u(t)$$

(b)

$$(s^2Y(s) - 2s - 1) + 4(sY(s) - 2) + 4Y(s) = (s+1)\frac{1}{s+1}$$

or

$$(s^2 + 4s + 4)Y(s) = 2s + 10$$

and

$$Y(s) = \frac{2s + 10}{s^2 + 4s + 4} = \frac{2s + 10}{(s+2)^2} = \frac{2}{s+2} + \frac{6}{(s+2)^2}$$

$$y(t) = (2 + 6t)e^{-2t}u(t)$$

(c)

$$(s^2Y(s) - s - 1) + 6(sY(s) - 1) + 25Y(s) = (s+2)\frac{25}{s} = 25 + \frac{50}{s}$$

or

$$(s^2 + 6s + 25)Y(s) = s + 32 + \frac{50}{s} = \frac{s^2 + 32s + 50}{s}$$

and

$$Y(s) = \frac{s^2 + 32s + 50}{s(s^2 + 6s + 25)} = \frac{2}{s} + \frac{-s + 20}{s^2 + 6s + 25}$$

$$y(t) = [2 + 5.836e^{-3t} \cos(4t - 99.86^\circ)]u(t)$$

4.3-2 (a) All initial conditions are zero. The zero-input response is zero. The entire response found in Prob. 4.3-2a is zero-state response, that is

$$y_{zs}(t) = (e^{-t} - e^{-2t})u(t)$$

$$y_{zi}(t) = 0$$

(b) The Laplace transform of the differential equation is

$$(s^2Y(s) - 2s - 1) + 4(sY(s) - 2) + 4Y(s) = (s+1)\frac{1}{s+1}$$

or

$$(s^2 + 4s + 4)Y(s) - (2s + 9) = 1$$

or

$$(s^2 + 4s + 4)Y(s) = \underbrace{2s + 9}_{\text{i.c. terms}} + \underbrace{1}_{\text{input}}$$

$$Y(s) = \underbrace{\frac{2s + 9}{s^2 + 4s + 4}}_{\text{zero-input}} + \underbrace{\frac{1}{s^2 + 4s + 4}}_{\text{zero-state}}$$

$$= \underbrace{\frac{2}{s+2}}_{\text{zero-input}} + \underbrace{\frac{5}{(s+2)^2}}_{\text{zero-input}} + \underbrace{\frac{1}{(s+2)^2}}_{\text{zero-state}}$$

$$y(t) = \underbrace{(2 + 5t)e^{-2t}}_{\text{zero-input}} + \underbrace{te^{-2t}}_{\text{zero-state}}$$

(c) The Laplace transform of the equation is

$$(s^2 Y(s) - s - 1) + 6(sY(s) - 1) + 25Y(s) = 25 + \frac{50}{s}$$

or

$$(s^2 + 6s + 25)Y(s) = \underbrace{s + 7}_{\text{i.c. terms}} + \underbrace{25 + \frac{50}{s}}_{\text{input}}$$

$$\begin{aligned} Y(s) &= \underbrace{\frac{s+7}{s^2+6s+25}}_{\text{zero-input}} + \underbrace{\frac{25s+50}{s(s^2+6s+25)}}_{\text{zero-state}} \\ &= \left( \frac{s+7}{s^2+6s+25} \right) + \left( \frac{2}{s} + \frac{-2s+13}{s^2+6s+25} \right) \\ y(t) &= \underbrace{\left[ \sqrt{2}e^{-3t} \cos\left(4t - \frac{\pi}{4}\right) \right]}_{\text{zero-input}} + \underbrace{\left[ 2 + 5.154e^{-3t} \cos(4t - 112.83^\circ) \right]}_{\text{zero-state}} \end{aligned}$$

4.3-3 (a) Laplace transform of the two equations yields

$$\begin{aligned} (s+3)Y_1(s) - 2Y_2(s) &= \frac{1}{s} \\ -2Y_1(s) + (2s+4)Y_2(s) &= 0 \end{aligned}$$

Using Cramer's rule, we obtain

$$\begin{aligned} Y_1(s) &= \frac{s+2}{s(s^2+5s+4)} = \frac{s+2}{s(s+1)(s+4)} = \frac{1/2}{s} - \frac{1/3}{s+1} - \frac{1/6}{s+4} \\ Y_2(s) &= \frac{1}{s(s^2+5s+4)} = \frac{1}{s(s+1)(s+4)} = \frac{1/4}{s} - \frac{1/3}{s+1} + \frac{1/12}{s+4} \end{aligned}$$

and

$$\begin{aligned} y_1(t) &= \left( \frac{1}{2} - \frac{1}{3}e^{-t} - \frac{1}{6}e^{-4t} \right) u(t) \\ y_2(t) &= \left( \frac{1}{4} - \frac{1}{3}e^{-t} + \frac{1}{12}e^{-4t} \right) u(t) \end{aligned}$$

If  $H_1(s)$  and  $H_2(s)$  are the transfer functions relating  $y_1(t)$  and  $y_2(t)$ , respectively to the input  $f(t)$ , thus

$$H_1(s) = \frac{s+2}{s^2+5s+4} \quad \text{and} \quad H_2(s) = \frac{1}{s^2+5s+4}$$

(b) The Laplace transform of the equations are

$$\begin{aligned} (s+2)Y_1(s) - (s+1)Y_2(s) &= 0 \\ -(s+1)Y_1(s) + (2s+1)Y_2(s) &= 0 \end{aligned}$$

Application of Cramer's rule yields

$$\begin{aligned} Y_1(s) &= \frac{s+1}{s(s^2+3s+1)} = \frac{s+1}{s(s+0.382)(s+2.618)} = \frac{1}{s} - \frac{0.724}{s+0.382} - \frac{0.276}{s+2.618} \\ Y_2(s) &= \frac{s+2}{s(s^2+3s+1)} = \frac{s+2}{s(s+0.382)(s+2.618)} = \frac{2}{s} - \frac{1.894}{s+0.382} - \frac{0.1056}{s+2.618} \end{aligned}$$

$$H_1(s) = \frac{s+1}{s^2+3s+1} \quad \text{and} \quad H_2(s) = \frac{s+2}{s^2+3s+1}$$

$$\begin{aligned} y_1(t) &= (1 - 0.724e^{-0.382t} - 0.276e^{-2.618t}) u(t) \\ y_2(t) &= (2 - 1.894e^{-0.382t} - 0.1056e^{-2.618t}) u(t) \end{aligned}$$

4.3-4 At  $t = 0$ , the inductor current  $y_1(0) = 4$  and the capacitor voltage is 16 volts. After  $t = 0$ , the loop equations are

$$2 \frac{dy_1}{dt} - 2 \frac{dy_2}{dt} + 5y_1(t) - 4y_2(t) = 40$$

$$-2 \frac{dy_1}{dt} - 4y_1(t) + 2 \frac{dy_2}{dt} + 4y_2(t) + \int_{-\infty}^t y_2(\tau) d\tau = 0$$

If

$$y_1(t) \longleftrightarrow Y_1(s), \quad \frac{dy_1}{dt} = sY_1(s) - 4$$

$$y_2(t) \longleftrightarrow Y_2(s), \quad \frac{dy_2}{dt} = sY_2(s)$$

$$\int_{-\infty}^t y_2(\tau) d\tau \longleftrightarrow \frac{1}{s}Y_2(s) + \frac{16}{s}$$

Laplace transform of the loop equations are

$$2(sY_1(s) - 4) - 2sY_2(s) + 5Y_1(s) - 4Y_2(s) = \frac{40}{s}$$

$$-2(sY_1(s) - 4) - 4Y_1(s) + 2sY_2(s) + 4Y_2(s) + \frac{1}{s}Y_2(s) + \frac{16}{s} = 0$$

Or

$$(2s + 5)Y_1(s) - (2s + 4)Y_2(s) = 8 + \frac{40}{s}$$

$$-(2s + 4)Y_1(s) + (2s + 4 + \frac{1}{s})Y_2(s) = -8 - \frac{16}{s}$$

Cramer's rule yields

$$Y_1(s) = \frac{4(6s^2 + 13s + 5)}{s(s^2 + 3s + 2.5)} = \frac{8}{s} + \frac{16s + 28}{s^2 + 3s + 2.5}$$

$$y_1(t) = [8 + 17.89e^{-1.5t} \cos(\frac{1}{2} - 26.56^\circ)]u(t)$$

$$Y_2(s) = \frac{20(s + 2)}{(s^2 + 3s + 2.5)}$$

$$y_2(t) = 20\sqrt{2}e^{-1.5t} \cos(\frac{1}{2} - \frac{\pi}{4})u(t)$$

4.3-5 (a)  $\frac{3s+3}{s^2+11s+24}$  (b)  $\frac{3s^2+7s+6}{s^2+6s^2-11s+6}$  (c)  $\frac{3s+2}{s(s^2+4)}$

4.3-6 (a)

$$\frac{d^2y}{dt^2} + 3 \frac{dy}{dt} + 8y(t) = \frac{df}{dt} + 5f(t)$$

(b)

$$\frac{d^3y}{dt^3} + 8 \frac{d^2y}{dt^2} + 5 \frac{dy}{dt} + 7y(t) = \frac{d^2f}{dt^2} + 3 \frac{df}{dt} + 5f(t)$$

(c)

$$\frac{d^2y}{dt^2} - 2 \frac{dy}{dt} + 5y(t) = 5 \frac{d^2f}{dt^2} + 7 \frac{df}{dt} + 2f(t)$$

4.3-7 (a) (i)  $F(s) = \frac{1}{s+3}$  and

$$Y(s) = \frac{s+5}{(s+3)(s^2+5s+6)} = \frac{s+5}{(s+2)(s+3)^2} = \frac{3}{s+2} - \frac{3}{s+3} - \frac{2}{(s+3)^2}$$

$$y(t) = (3e^{-2t} - 3e^{-3t} - 2te^{-3t})u(t)$$

(ii)  $F(s) = \frac{1}{s+4}$

$$Y(s) = \frac{s+5}{(s+2)(s+3)(s+4)} = \frac{3/2}{s+2} - \frac{2}{s+3} + \frac{1/2}{s+4}$$

$$y(t) = \frac{3}{2}e^{-2t} - 2e^{-3t} + \frac{1}{2}e^{-4t}u(t)$$

(iii) The input here is the input in (ii) delayed by 5 secs. Therefore  $F(s) = \frac{1}{s+4}e^{-5s}$

$$Y(s) = \frac{s+5}{(s+2)(s+3)(s+4)}e^{-5s} = \left[ \frac{3/2}{s+2} - \frac{2}{s+3} + \frac{1/2}{s+4} \right] e^{-5s}$$

$$y(t) = \frac{3}{2}e^{-2(t-5)} - 2e^{-3(t-5)} + \frac{1}{2}e^{-4(t-5)}u(t-5)$$

(iv) The input here is equal to the input in (ii) multiplied by  $e^{20}$  because  $e^{-4(t-5)} = e^{20}e^{-4t}$ . Therefore the output is equal to the output in (ii) multiplied by  $e^{20}$ .

$$y(t) = e^{20} \left[ \frac{3}{2}e^{-2t} - 2e^{-3t} + \frac{1}{2}e^{-4t} \right] u(t)$$

(v) The input here is equal to the input in (iii) multiplied by  $e^{-20}$  because  $e^{-4t}u(t-5) = e^{-20}e^{-4(t-5)}u(t-5)$ . Therefore

$$y(t) = e^{-20} \left[ \frac{3}{2}e^{-2(t-5)} - 2e^{-3(t-5)} + \frac{1}{2}e^{-4(t-5)} \right] u(t-5)$$

(b)  $(D^2 + 2D + 5)y(t) = (2D + 3)f(t)$

4.3-8 (a)  $F(s) = \frac{10}{s}$

$$Y(s) = \frac{10(2s+3)}{s(s^2+2s+5)} = \frac{6}{s} + \frac{-6s+8}{s^2+2s+5}$$

$$y(t) = [6 + 9.22e^{-t} \cos(2t - 130.6^\circ)]u(t)$$

(b)  $f(t) = u(t-5)$  and  $F(s) = \frac{1}{s}e^{-5s}$

$$Y(s) = \frac{2s+3}{s(s^2+2s+5)}e^{-5s} = \left[ \frac{0.6}{s} + \frac{1}{10} \left( \frac{-6s+8}{s^2+2s+5} \right) \right] e^{-5s}$$

$$y(t) = \frac{1}{10} [6 + 9.22e^{-(t-5)} \cos[2(t-5) - 130.6^\circ]]u(t-5)$$

4.3-9  $F(s) = \frac{1}{s}$

$$Y(s) = \frac{1}{s^2+9} \quad \text{and} \quad y(t) = \frac{1}{3} \sin 3t u(t)$$

4.3-10 (a) Let  $H(s)$  be the system transfer function.

$$Y(s) = F(s)H(s)$$

Consider an input  $f_1(t) = f(t)$ . Then  $F_1(s) = sF(s)$ . If the output is  $y_1(t)$  and its transform is  $Y_1(s)$ , then

$$Y_1(s) = F_1(s)H(s) = sF(s)H(s) = sY(s)$$

This shows that  $y_1(t) = dy/dt$ .

(b) Using similar argument we show that for the input  $\int_0^t f(\tau) d\tau$ , the output is  $\int_0^t y(\tau) d\tau$ . Because  $u(t)$  is an integral of  $\delta(t)$ , the unit step response is the integral of the unit impulse response  $h(t)$ .

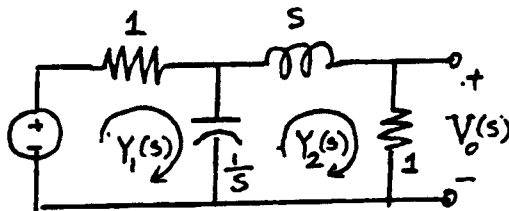

Fig. S4.4-1

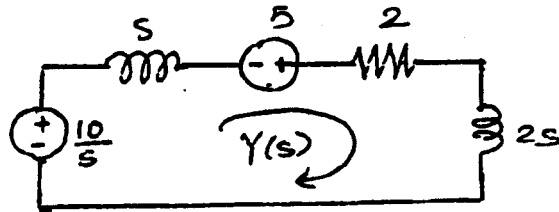

Fig. S4.4-2

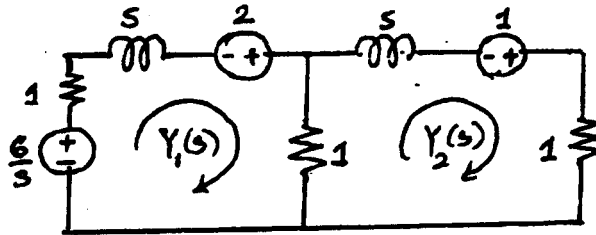

Fig. S4.4-4

4.4-1 Figure S4.4-1 shows the transformed network. The loop equations are

$$\begin{aligned} (1 + \frac{1}{s})Y_1(s) - \frac{1}{s}Y_2(s) &= \frac{1}{(s+1)^2} \\ -\frac{1}{s}Y_1(s) + (s+1 + \frac{1}{s})Y_2(s) &= 0 \end{aligned}$$

or

$$\begin{bmatrix} \frac{s+1}{s} & -\frac{1}{s} \\ -\frac{1}{s} & s^2+s+1 \end{bmatrix} \begin{bmatrix} Y_1(s) \\ Y_2(s) \end{bmatrix} = \begin{bmatrix} \frac{1}{(s+1)^2} \\ 0 \end{bmatrix}$$

Cramer's rule yields

$$\begin{aligned} Y_2(s) &= \frac{1}{(s+1)^2(s^2+2s+2)} = \frac{1}{(s+1)^2} - \frac{1}{s^2+2s+2} \\ v_0(t) = y_2(t) &= (te^{-t} - \frac{1}{2}e^{-t} \sin t)u(t) \end{aligned}$$

4.4-2 Before the switch is opened, the inductor current is 5A, that is  $y(0) = 5$ . Figure S4.4-2b shows the transformed circuit for  $t \geq 0$  with initial condition generator. The current  $Y(s)$  is given by

$$\begin{aligned} Y(s) &= \frac{(10/s) + 5}{3s+2} = \frac{5s+10}{s(3s+2)} = \frac{5}{3} \left[ \frac{3}{s} - \frac{2}{s+(2/3)} \right] \\ y(t) &= (5 - \frac{10}{3}e^{-2t/3})u(t) \end{aligned}$$

4.4-3 The impedance seen by the source  $f(t)$  is

$$Z(s) = \frac{Ls(1/Cs)}{Ls + (1/Cs)} = \frac{Ls}{LCs^2 + 1} = \frac{Ls\omega_0^2}{s^2 + \omega_0^2}$$

The current  $Y(s)$  is given by

$$Y(s) = \frac{F(s)}{Z(s)} = \frac{s^2 + \omega_0^2}{Ls\omega_0^2} F(s)$$

(a)

$$F(s) = \frac{As}{s^2 + \omega_0^2}, \quad Y(s) = \frac{A}{L\omega_0^2} \quad \text{and} \quad y(t) = \frac{A}{L\omega_0^2} \delta(t)$$

(b)

$$F(s) = \frac{A\omega_0}{s^2 + \omega_0^2}, \quad Y(s) = \frac{A}{L\omega_0 s} \quad \text{and} \quad y(t) = \frac{A}{L\omega_0} u(t)$$



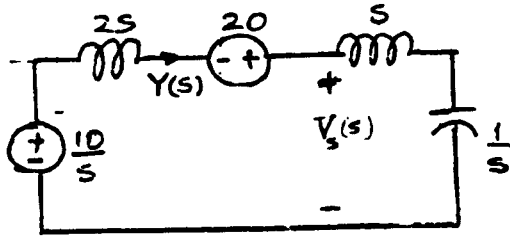

Fig. S4.4-5

4.4-4 At  $t = 0$ , the steady-state values of currents  $y_1$  and  $y_2$  is  $y_1(0) = 2$ ,  $y_2(0) = 1$ .

Figure S4.4-4 shows the transformed circuit for  $t \geq 0$  with initial condition generators. The loop equations are

$$\begin{aligned}(s+2)Y_1(s) - Y_2(s) &= 2 + \frac{6}{s} \\ -Y_1(s) + (s+2)Y_2(s) &= 1\end{aligned}$$

Cramer's rule yields

$$Y_1(s) = \frac{2s^2 + 11s + 12}{s(s+1)(s+3)} = \frac{4}{s} - \frac{3/2}{s+1} - \frac{1/2}{s+3}$$

$$Y_2(s) = \frac{s^2 + 4s + 6}{s(s+1)(s+3)} = \frac{2}{s} - \frac{3/2}{s+1} + \frac{1/2}{s+3}$$

$$y_1(t) = (4 - \frac{3}{2}e^{-t} - \frac{1}{2}e^{-3t})u(t)$$

$$y_2(t) = (2 - \frac{3}{2}e^{-t} + \frac{1}{2}e^{-3t})u(t)$$

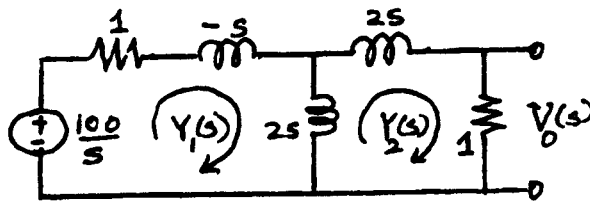

Fig. S4.4-6

4.4-5 The current in the 2H inductor at  $t = 0$  is 10A. The transformed circuit with initial condition generators is shown in Figure S4.4-5 for  $t \geq 0$ .

$$Y(s) = \frac{10 + 20}{3s + \frac{1}{s} + 1} = \frac{20s + 10}{3s^2 + s + 1} = \frac{20}{s} \left[ \frac{s + 0.5}{s^2 + \frac{1}{3}s + \frac{1}{3}} \right]$$

Here  $A = 1$ ,  $B = 0.5$ ,  $a = \frac{1}{3}$ ,  $c = \frac{1}{3}$ ,  $b = \frac{\sqrt{11}}{3}$

$$r = \sqrt{\frac{11}{11}} = 1.168 \quad \theta = \tan^{-1}\left(\frac{-0.5}{\frac{1}{3}}\right) = -31.1^\circ$$

$$y(t) = \frac{20}{3}(1.168)e^{-t/3} \cos\left(\frac{\sqrt{11}}{3}t - 31.1^\circ\right)u(t)$$

$$= 7.787e^{-t/3} \cos\left(\frac{\sqrt{11}}{3}t - 31.1^\circ\right)u(t)$$

The voltage  $v_o(t)$  across the switch is

$$V_o(s) = (s + \frac{1}{s})Y(s) = \left(\frac{s^2 + 1}{s}\right)\left(\frac{20s + 10}{3s^2 + s + 1}\right) = \frac{20}{s} \frac{(s^2 + 1)(s + 0.5)}{s^2 + \frac{1}{3}s + \frac{1}{3}}$$

$$= \frac{20}{3} \left[ 1 + \frac{3/2}{s} + \frac{1}{6} \frac{-8s + 1}{s^2 + 1/3s + 1/3} \right]$$

$$v_o(t) = \frac{20}{3}\delta(t) + [10 + 9.045e^{-t/3} \cos\left(\frac{\sqrt{11}}{3}t - 152.2^\circ\right)]u(t)$$

4.4-6 Figure S4.4-6 shows the transformed circuit with mutually coupled inductor replaced by their equivalents (see Fig. 4.15b). The loop equations are

$$\begin{aligned}(s+1)Y_1(s) - 2sY_2(s) &= \frac{100}{s} \\ -2sY_1(s) + (4s+1)Y_2(s) &= 0\end{aligned}$$

Cramer's rule yields

$$Y_2(s) = \frac{40}{(s+0.2)}$$

and

$$v_o(t) = y_2(t) = 40e^{-t/5}u(t)$$

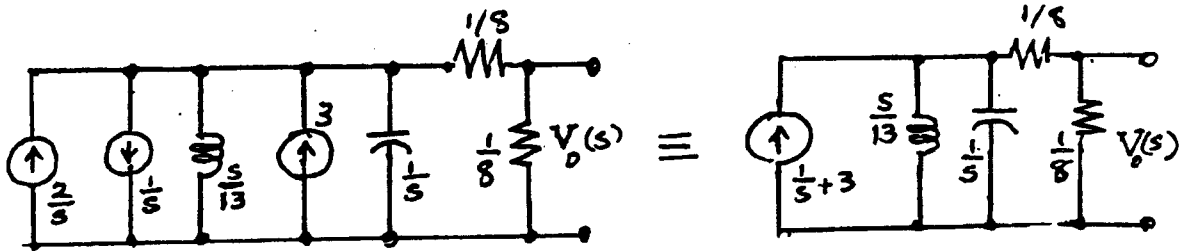

Fig. S4.4-7

4.4-7 Figure S4.4-7 shows the transformed circuit with parallel form of initial condition generators. The admittance  $W(s)$  seen by the source is

$$W(s) = \frac{13}{s} + s + 4 = \frac{s^2 + 4s + 13}{s}$$

The voltage across terminals a b is

$$V_{ab}(s) = \frac{I(s)}{W(s)} = \frac{\frac{1}{s} + 3}{\frac{s^2 + 4s + 13}{s}} = \frac{3s + 1}{s^2 + 4s + 13}$$

Also

$$V_o(s) = \frac{1}{2}V_{ab}(s) = \frac{3s + 1}{2(s^2 + 4s + 13)}$$

and

$$v_o(t) = 1.716e^{-2t} \cos(3t + 29^\circ)u(t)$$

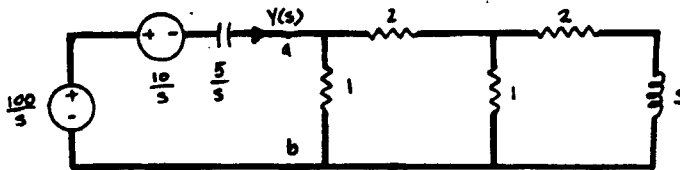

Fig. S4.4-8

4.4-8 The capacitor voltage at  $t = 0$  is 10 volts. The inductor current is zero. The transformed circuit with initial condition generators is shown for  $t > 0$  in Fig. S4.4-8.

To determine the current  $Y(s)$ , we determine  $Z_{ab}(s)$ , the impedance seen across terminals ab:

$$Z_{ab}(s) = \frac{1}{1 + \left( \frac{1}{2 + \frac{s}{s+3}} \right)} = \frac{3s + 8}{4s + 11}$$

$$\begin{aligned}
 \text{Also } Y(s) &= \frac{90}{\frac{1}{s} + \left(\frac{3s+8}{4s+11}\right)} \\
 &= \frac{90(4s+11)}{3s^2 + 28s + 55} \\
 &= \frac{30(4s+11)}{s^2 + \frac{28}{3}s + \frac{55}{3}} \\
 &= \frac{30(4s+11)}{(s+2.8)(s+6.53)} \\
 &= -\frac{1.61}{s+2.8} + \frac{121.61}{s+6.53}
 \end{aligned}$$

$$\text{and } y(t) = [121.61e^{-6.53t} - 1.61e^{-2.8t}]u(t)$$

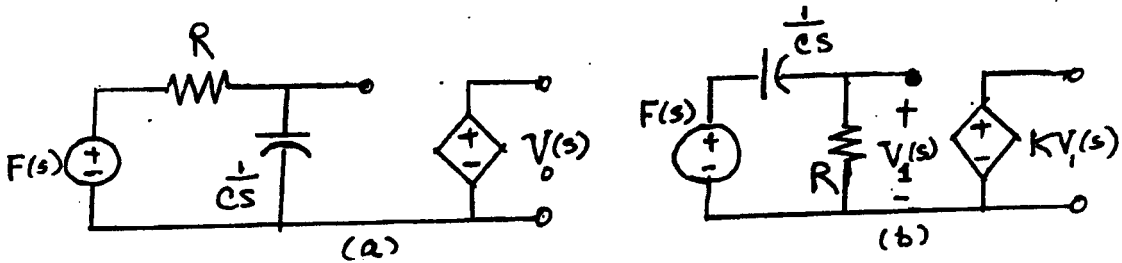

Fig. S4.4-9

4.4-9 Figure S4.4-9 shows the transformed circuit (with noninverting op amp replaced by its equivalent as shown in Fig. 4.16) from Fig. S4.4-9a.

$$V_0(s) = KV_1(s) = K \frac{1}{Cs} R + \frac{1}{Cs} F(s) = \frac{Ka}{s+a} \quad a = \frac{1}{RC}$$

Therefore

$$H(s) = \frac{Ka}{s+a} \quad a = \frac{1}{RC}, \quad K = 1 + \frac{R_0}{R_a}$$

Similarly for the circuit in Fig. P4.4-9b, we can show (see Fig. S4.4-9)

$$H(s) = \frac{Ks}{s+a}$$

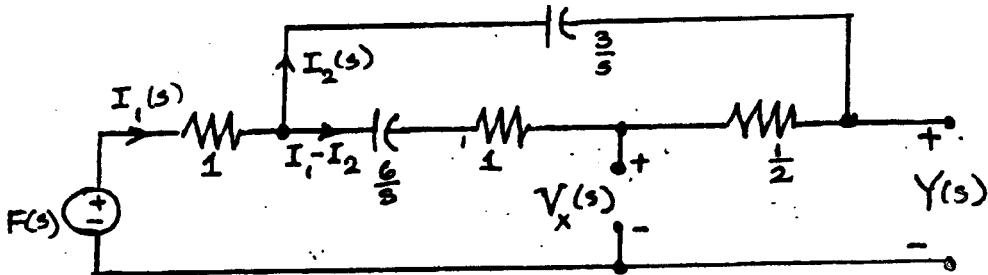

Fig. S4.4-10

4.4-10 Figure S4.4-10 shows the transformed circuit. The op amp input voltage is  $V_x(s) \approx 0$ . The loop equations are

$$\begin{aligned}
 I_1(s) + \left(\frac{6}{s} + 1\right)[I_1(s) - I_2(s)] &= F(s) \\
 -\frac{3}{s}I_2(s) + \left(\frac{6}{s} + \frac{3}{2}\right)[I_1(s) - I_2(s)] &= 0
 \end{aligned}$$

Cramer's rule yields

$$I_1(s) = \frac{s(s+6)}{s^2+8s+12} F(s), \quad I_2(s) = \frac{s(s+4)}{s^2+8s+12}$$

$$Y(s) = -\frac{1}{2}[I_1(s) - I_2(s)] = \frac{-s}{s^2+8s+12} F(s)$$

The transfer function

$$H(s) = \frac{-s}{s^2+8s+12}$$

4.4-11 (a)

$$Y(s) = \frac{6s^2+3s+10}{s(2s^2+6s+5)}$$

$$y(0^+) = \lim_{s \rightarrow \infty} sY(s) = 3$$

$$y(\infty) = \lim_{s \rightarrow 0} sY(s) = 2$$

(b)

$$Y(s) = \frac{6s^2+3s+10}{(s+1)(2s^2+6s+5)}$$

$$y(0^+) = \lim_{s \rightarrow \infty} sY(s) = 3$$

$$y(\infty) = \lim_{s \rightarrow 0} sY(s) = 0$$

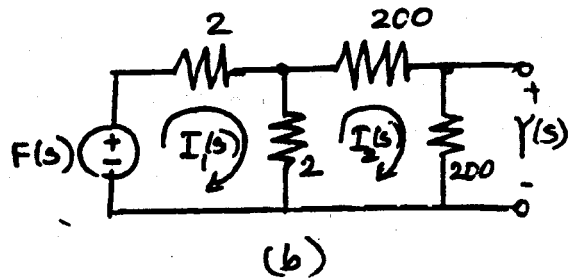
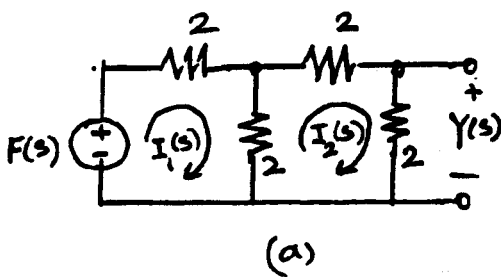

Figure S4.5-1

4.5-1 (a) The loop equations are

$$\begin{aligned} 4I_1 - 2I_2 &= F(s) \\ -2I_1 + 6I_2 &= 0 \end{aligned}$$

Cramer's rule yields

$$I_2(s) = \frac{2}{20} F(s) = \frac{1}{10} F(s)$$

and

$$Y(s) = 2I_2(s) = \frac{1}{5} F(s)$$

Therefore  $H(s) = \frac{1}{5}$  not  $\frac{1}{4}$ .  
(b)

$$\begin{aligned} 4I_1 - 2I_2 &= F(s) \\ -2I_1 + 400I_2 &= 0 \end{aligned}$$

Cramer's rule yields

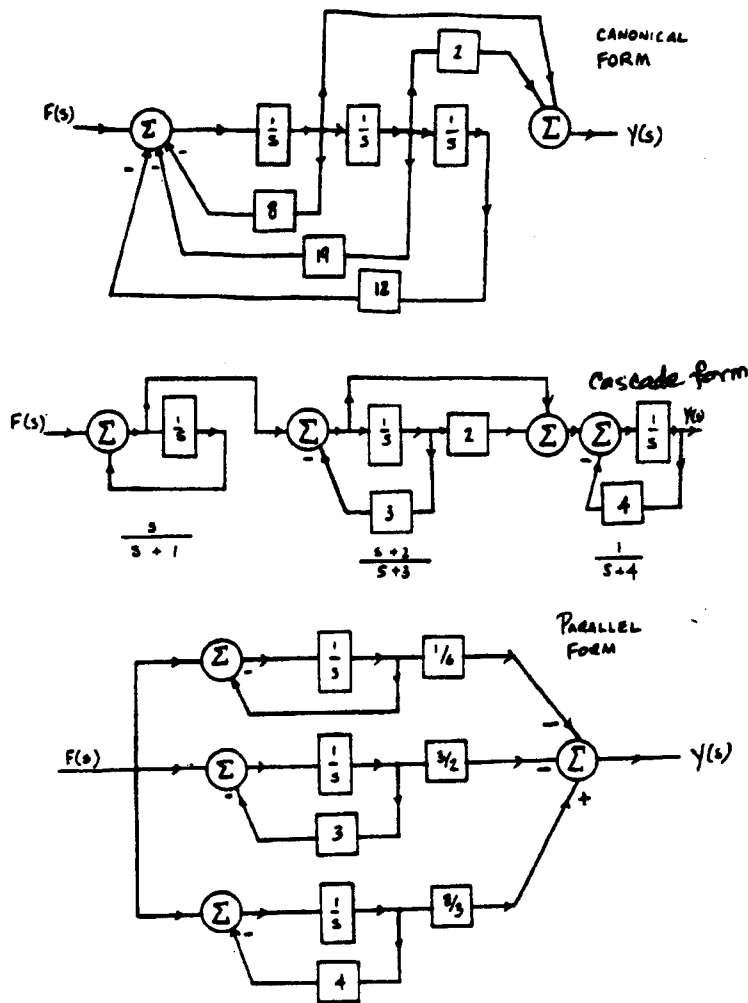

Fig. S4.6-1

$$I_2(s) = \frac{2}{1596} F(s)$$

$$Y(s) = 200I_2(s) = \frac{400}{1596} F(s) = \frac{1}{3.99} F(s)$$

In this case  $H(s)$  is very close to  $1/4$ . This is because the second ladder section causes a negligible load on the first. The Cascade rule applies only when the successive subsystems do not load the preceding subsystems.

4.6-1

$$H(s) = \frac{s^2 + 2s}{s^3 + 8s^2 + 19s + 12} = \left(\frac{s}{s+1}\right) \left(\frac{s+2}{s+3}\right) \left(\frac{1}{s+4}\right) = \frac{-1/6}{s+1} - \frac{3/2}{s+3} + \frac{8/3}{s+4}$$

$$\text{Also } H(s) = \frac{b_2s^2 + b_1s + b_0}{s^3 + a_2s^2 + a_1s + a_0}$$

with  $a_0 = 12$ ,  $a_1 = 19$ ,  $a_2 = 8$ , and  $b_0 = 0$ ,  $b_1 = 2$ ,  $b_2 = 1$ . Figure S4.6-1 shows the canonical, series and parallel realizations.

4.6-2 (a)

$$H(s) = \frac{3s(s+2)}{(s+1)(s^2+2s+2)} = \frac{3s^2+6s}{s^3+3s^2+4s+2} = \left(\frac{3s}{s+1}\right) \left(\frac{s+2}{s^2+2s+2}\right) = -\frac{3}{s+1} + \frac{6s+6}{s^2+2s+2}$$

For the canonical form, we have  $a_0 = 2$ ,  $a_1 = 4$ ,  $a_2 = 3$ , and  $b_0 = 0$ ,  $b_1 = 6$ ,  $b_2 = 3$ . Figure S4.6-2a shows a canonical, cascade and parallel realizations. Note that the roots of  $s^2+2s+2$  are complex. Therefore the quadratic term must be realized directly.

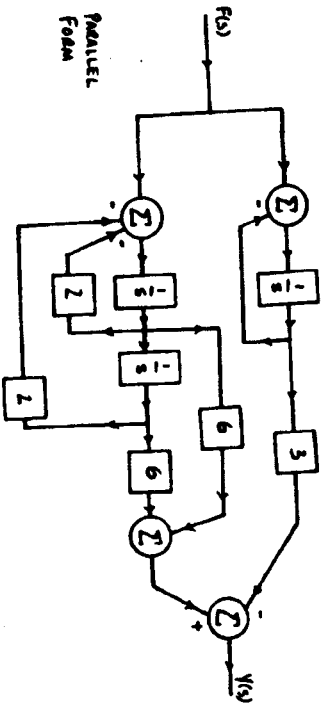
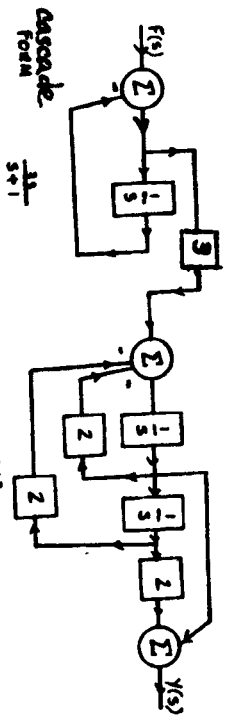
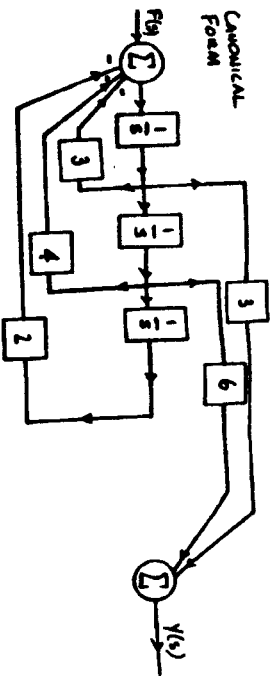

Fig. 54-6-2a

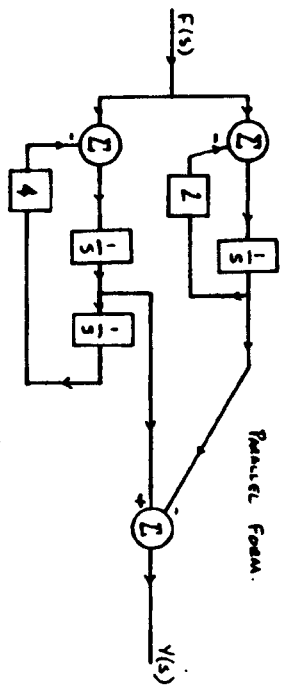
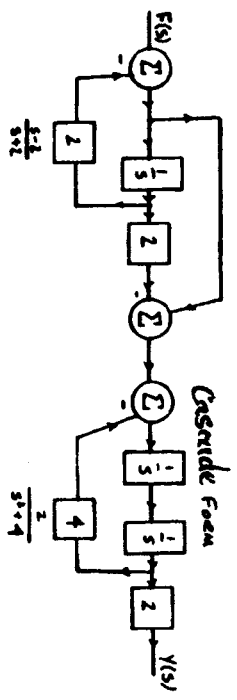
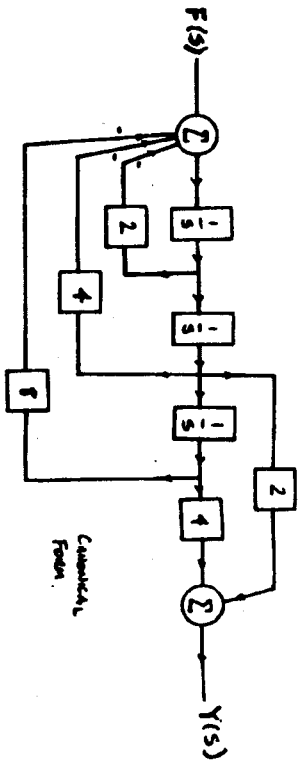

Fig. 54-6-2b

(b)

$$H(s) = \frac{2s-4}{(s+2)(s^2+4)} = \frac{2s-4}{s^3+2s^2+4s+8}$$

$$= \frac{2(s-2)}{s^3+2s^2+4s+8} = \left(\frac{s-2}{s+2}\right) \left(\frac{2}{s^2+4}\right) = -\frac{1}{s+2} + \frac{s}{s^2+4}$$

For a canonical forms, we have  $a_0 = 8, a_1 = 4, a_2 = 2,$  and  $b_0 = -4, b_1 = 2, b_2 = 0, b_3 = 0.$  Figure S4.6-2b shows a canonical, cascade and parallel realizations.

4.6-3

$$H(s) = \frac{2s+3}{5(s^4+7s^3+16s^2+12s)} = \frac{0.4s+0.6}{s^4+7s^3+16s^2+12s}$$

$$= \left(\frac{1}{s}\right) \left(\frac{1}{s+2}\right) \left(\frac{1}{s+2}\right) \left(\frac{0.4s+0.6}{s+3}\right) = \frac{\frac{1}{20}}{s} - \frac{\frac{1}{4}}{s+2} + \frac{\frac{1}{10}}{(s+2)^2} + \frac{\frac{1}{5}}{s+3}$$

Figure S4.6-3 shows a canonical, cascade and parallel realizations.

4.6-4

$$H(s) = \frac{s(s+1)(s+2)}{(s+5)(s+6)(s+8)} = \frac{s^3+3s^2+2s}{s^3+19s^2+118s+240} = 1 - \frac{20}{s+5} + \frac{60}{s+6} - \frac{56}{s+8}$$

For a canonical form  $a_0 = 24, a_1 = 118, a_2 = 19,$  and  $b_0 = 0, b_1 = 2, b_2 = 3, b_3 = 1.$  Figure S4.6-4 shows a canonical, cascade and parallel realizations.

4.6-5

$$H(s) = \frac{s^3}{(s+1)^2(s+2)(s+3)} = \frac{s^3}{s^4+7s^3+17s^2+17s+6}$$

$$= \left(\frac{s}{s+1}\right) \left(\frac{s}{s+1}\right) \left(\frac{s}{s+2}\right) \left(\frac{1}{s+3}\right) = -\frac{8}{s+2} + \frac{21}{s+3} + \frac{2}{s+1} - \frac{1}{(s+1)^2}$$

Figure S4.6-5 shows a canonical, cascade and parallel realizations.

4.6-6

$$H(s) = \frac{s^3}{(s+1)(s^2+4s+13)} = \frac{s^3}{s^3+5s^2+17s+13}$$

$$= \left(\frac{s}{s+1}\right) \left(\frac{s^2}{s^2+4s+13}\right) = -\frac{0.1}{s+1} + \frac{s^2-0.9s+1.3}{s^2+4s+13}$$

Figure S4.6-6 shows a canonical, cascade and parallel realizations.

4.6-7 Application of eq. (4.56) to Fig. P4.6-7a yields

$$H_1(s) = \frac{\frac{1}{(s+a)^2}}{1 + \frac{b^2}{(s+a)^2}} = \frac{1}{(s+a)^2 + b^2}$$

Figure P4.6-7b is also a feedback loop with forward gain  $G(s) = \frac{1}{s+a}$  and the loop gain  $\frac{b^2}{(s+a)^2}.$  Therefore

$$H_2(s) = \frac{\frac{1}{s+a}}{1 + \frac{b^2}{(s+a)^2}} = \frac{s+a}{(s+a)^2 + b^2}$$

The output in Fig. P4.6-7c is the same of  $B - aA$  times the output of Fig. P4.6-7a and  $A$  times the output of Fig. P4.6-7b. Therefore its transfer function is

$$H(s) = (B - aA)H_1(s) + AH_2(s)$$

$$= \frac{B - aA}{(s+a)^2 + b^2} + \frac{A(s+a)}{(s+a)^2 + b^2}$$

$$= \frac{As + B}{(s+a)^2 + b^2}$$

4.6-8 These transfer functions are readily realized by using the arrangement in Fig. 4.31 by a proper choice of  $Z_f(s)$  and  $Z(s).$

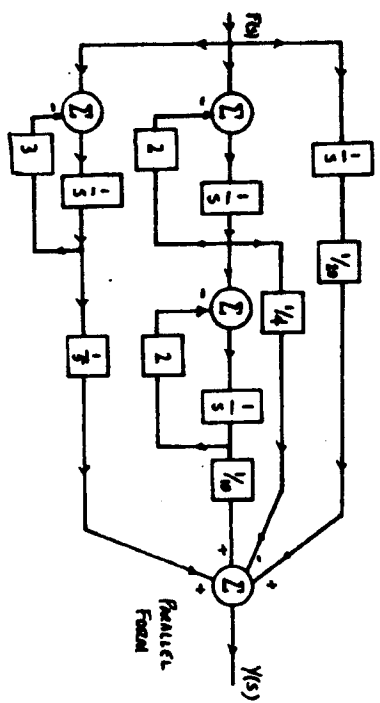
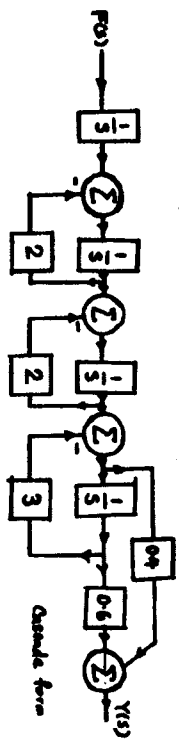
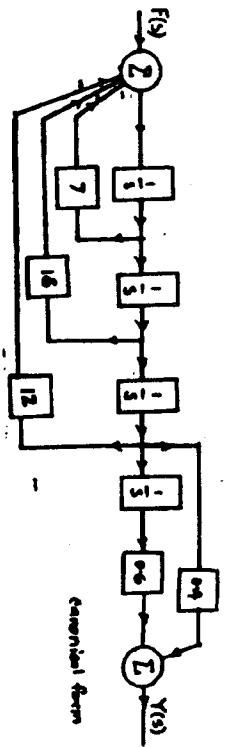
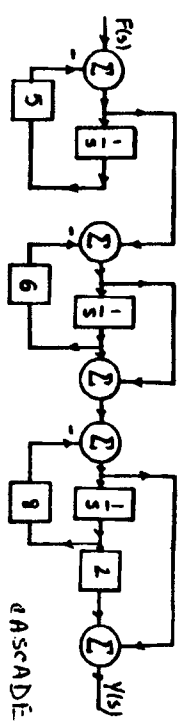
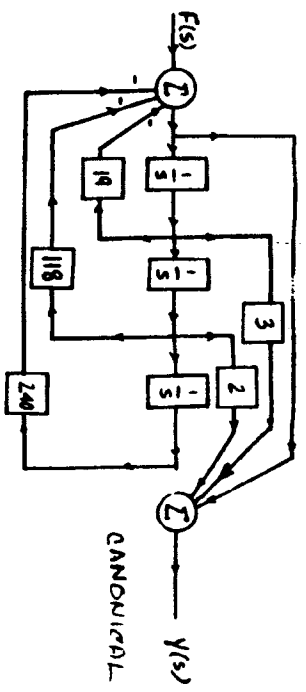

Fig. S4.6-3



$$\frac{s}{s+5}$$

$$\frac{s+1}{s+6}$$

$$\frac{s+1}{s+8}$$

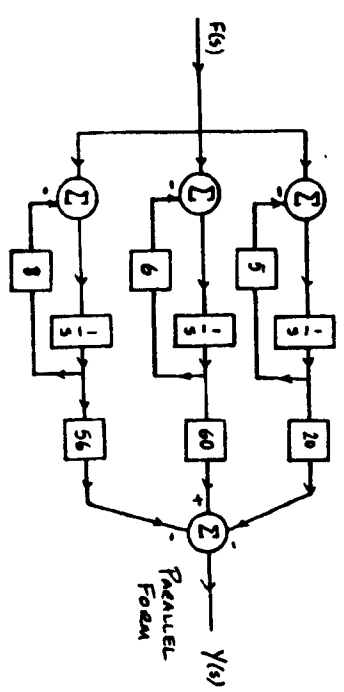

Fig. S4.6-4



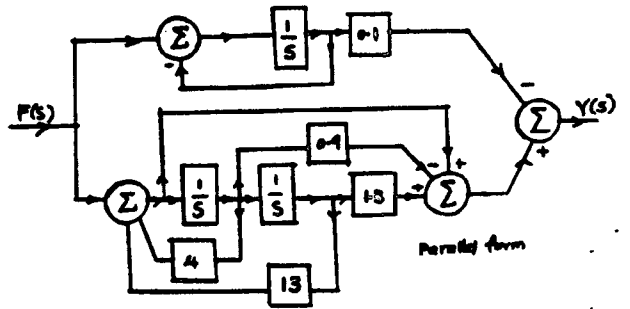
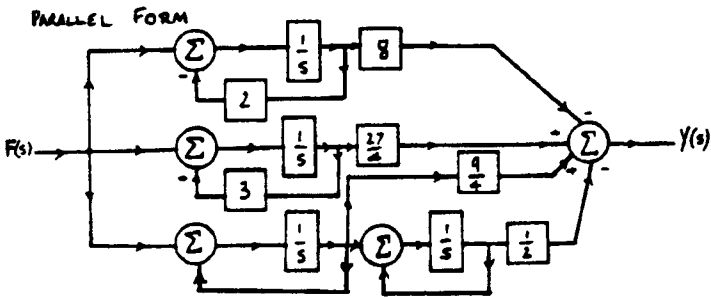
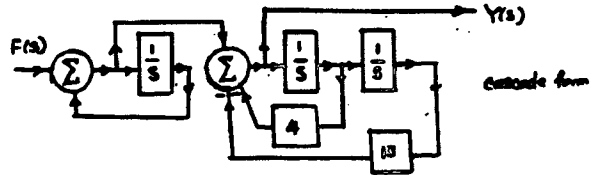
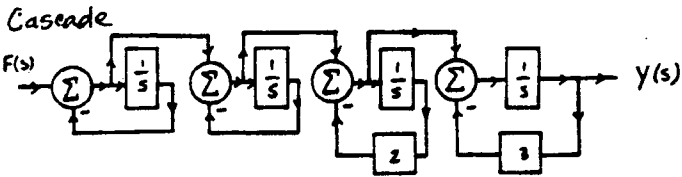
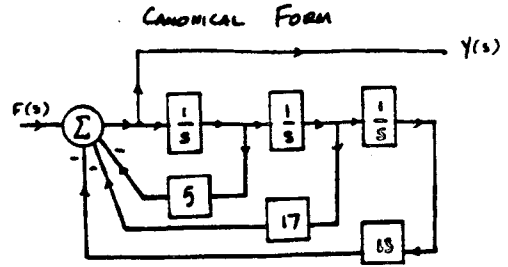
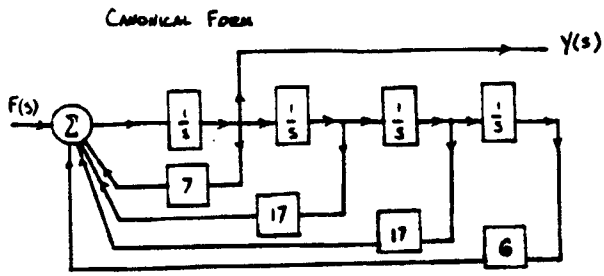

Fig. S4.6-5

Fig. S4.6-6

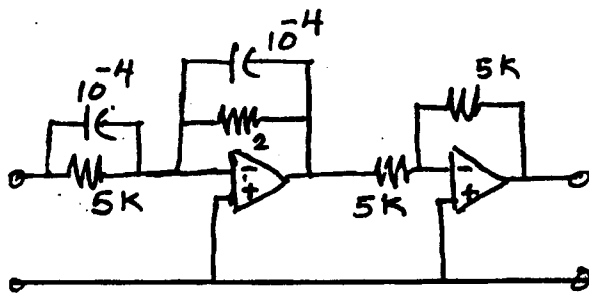
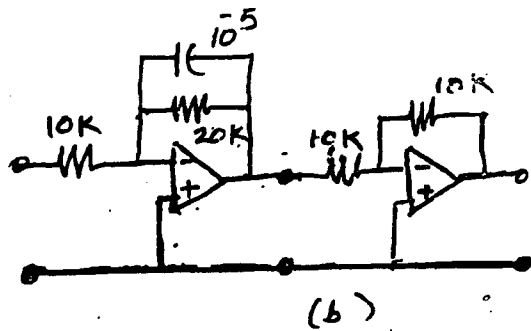
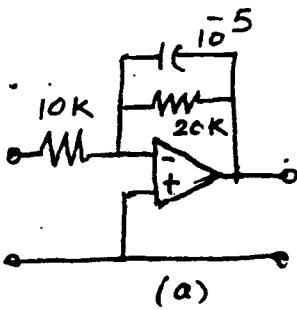

Fig. S4.6-8

(i) In Fig. S4.6-8a

$$Z_f(s) = \frac{\frac{R_f}{C_f s}}{R_f + \frac{1}{C_f s}} = \frac{1}{C_f(s+a)} \quad a = \frac{1}{R_f C_f}$$

$$Z(s) = R$$

and

$$H(s) = -\frac{Z_f(s)}{Z(s)} = -\frac{k}{s+a} \quad k = \frac{1}{RC_f}, \quad a = \frac{1}{R_f C_f}$$

Choose  $R = 10,000$ ,  $R_f = 20,000$  and  $C_f = 10^{-5}$ . This yields  $k = 10$  and  $a = 5$ . Therefore

$$H(s) = \frac{-10}{s+5}$$

(ii) This is same as (i) followed by an amplifier of gain  $-1$  as shown in Fig. S4.6-8b.

(iii) For the first stage in Fig. S4.6-8c (see Exercise E4.12, Fig. 4.35b),

$$Z_f(s) = \frac{1}{C_f(s+a)} \quad a = \frac{1}{R_f C_f}$$

$$Z(s) = \frac{1}{C(s+b)} \quad b = \frac{1}{RC}$$

and

$$H(s) = -\frac{Z_f(s)}{Z(s)} = -\frac{C}{C_f} \left( \frac{s+b}{s+a} \right)$$

Choose  $C = C_f = 10^{-4}$ ,  $R = 5000$ ,  $R_f = 2000$ . This yields

$$H(s) = -\left( \frac{s+2}{s+5} \right)$$

This is followed by an op amp of gain  $-1$  as shown in Fig. S4.6-8c. This yields

$$H(s) = \frac{s+2}{s+5}$$

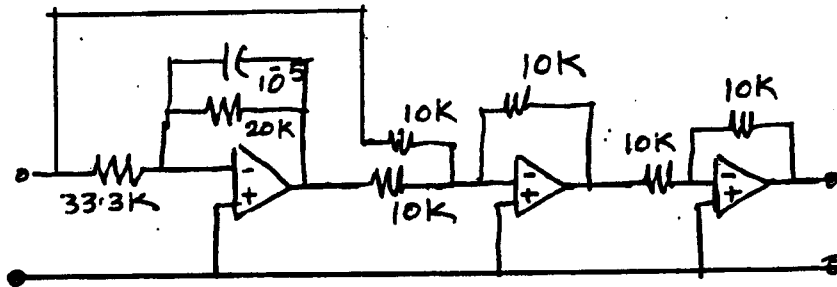

Fig. S4.6-9

4.6-9 One realization is given in Fig. S4.6-8c. For the other realization, we express  $H(s)$  as

$$H(s) = \frac{s+2}{s+5} = 1 - \frac{3}{s+5}$$

We realize  $H(s)$  as a parallel combination of  $H_1(s) = 1$  and  $H_2(s) = -3/(s+5)$  as shown in Fig. S4.6-9. The second summer serves as a summer for which the inputs are the input and output of the first stage. Because the summer has a gain  $-1$ , we need a third stage of gain  $-1$  to obtain the desired transfer functions.

4.6-10 Canonical realization of  $H(s)$  is shown in Fig. S4.6-10. Observe that this is identical to  $H(s)$  in Example 4.20 with a minor difference. Hence the op amp circuit in Fig. 4.36c can be used for our purpose with appropriate

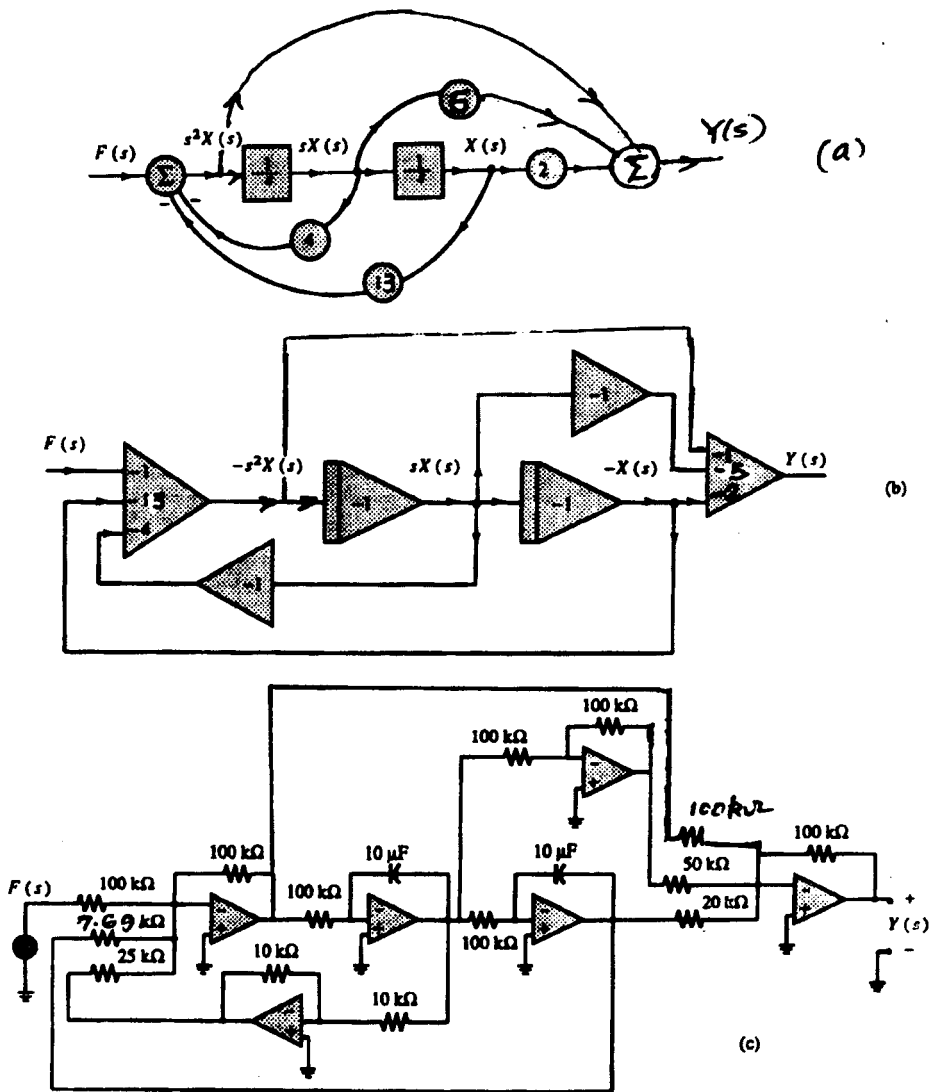

Fig. S4.6-11

changes in the element values. The last summer input resistors now are  $\frac{100}{3} \text{ k}\Omega$  and  $\frac{100}{7} \text{ k}\Omega$  instead of  $50 \text{ k}\Omega$  and  $20 \text{ k}\Omega$ .

4.6-11 We follow the procedure in Example 4.20 with appropriate modifications. In this case  $a_0 = 13$ ,  $a_1 = 4$ , and  $b_0 = 2$ ,  $b_1 = 5$ , and  $b_2 = 1$  (in Example 4.20, we have  $a_0 = 10$ ,  $a_1 = 4$ , and  $b_0 = 5$ ,  $b_1 = 2$ , and  $b_2 = 0$ ). Because  $b_2$  is nonzero here, we have one more feedforward connection. Figure S4.6-11 shows the development of the suitable realization.

4.7-1

$$H(j\omega) = \frac{j\omega + 2}{(j\omega)^2 + 5j\omega + 4} = \frac{j\omega + 2}{(4 - \omega^2) + j5\omega}$$

$$|H(j\omega)| = \sqrt{\frac{\omega^2 + 4}{(4 - \omega^2)^2 + (5\omega)^2}} = \sqrt{\frac{\omega^2 + 4}{\omega^4 + 17\omega^2 + 16}}$$

$$\angle H(j\omega) = \tan^{-1}\left(\frac{\omega}{2}\right) - \tan^{-1}\left(\frac{5\omega}{4 - \omega^2}\right)$$

(a)  $f(t) = 5 \cos(2t + 30^\circ)$ . Here  $\omega = 2$  and

$$|H(j2)| = \sqrt{\frac{2}{3}} = \frac{\sqrt{2}}{3}$$

$$\angle H(j\omega) = \tan^{-1} - \tan^{-1}(\infty) = 45^\circ - 90^\circ = -45^\circ$$

$$y(t) = 5 \frac{\sqrt{2}}{3} \cos(2t + 30^\circ - 45^\circ) = \sqrt{2} \cos(2t - 15^\circ)$$

(b)  $f(t) = 10 \sin(2t + 45^\circ)$

$$y(t) = 10 \left(\frac{\sqrt{2}}{3}\right) \sin(2t + 45^\circ - 45^\circ) = 2\sqrt{2} \sin 2t$$

(c)  $f(t) = 10 \cos(3t + 40^\circ)$ . Here  $\omega = 3$

$$|H(j\omega)| = \sqrt{\frac{13}{250}} = 0.228 \quad \text{and} \quad \angle H(j3) = 56.31^\circ - 108.43^\circ = -52.12^\circ$$

Therefore

$$y(t) = 10(0.228) \cos(3t + 40^\circ - 52.12^\circ) = 2.28 \cos(3t - 12.12^\circ)$$

4.7-2

$$H(j\omega) = \frac{j\omega + 3}{(j\omega + 2)^2}$$

$$|H(j\omega)| = \frac{\sqrt{\omega^2 + 9}}{\omega^2 + 4} \quad \text{and} \quad \angle H(j\omega) = \tan^{-1}\left(\frac{\omega}{3}\right) - \tan^{-1}\left(\frac{\omega}{2}\right)$$

(a)  $f(t) = \cos(2t + 60^\circ)$ . Here  $\omega = 2$

$$|H(j2)| = \frac{\sqrt{13}}{8} \quad \text{and} \quad \angle H(j2) = 33.69^\circ - 90^\circ = -56.31^\circ$$

Therefore

$$y(t) = \frac{\sqrt{13}}{8} \cos(2t + 60^\circ - 56.31^\circ) = \frac{\sqrt{13}}{8} \cos(2t + 3.69^\circ)$$

(b)  $f(t) = \sin(3t - 45^\circ)$  Here  $\omega = 3$  and

$$|H(j3)| = \frac{\sqrt{18}}{13} \quad \text{and} \quad \angle H(j3) = 45^\circ - 112.62^\circ = -67.62^\circ$$

Therefore

$$y(t) = \frac{\sqrt{18}}{13} \sin(3t - 45^\circ - 67.62^\circ) = \frac{\sqrt{18}}{13} \sin(3t - 112.62^\circ)$$

(c)  $f(t) = e^{j3t}$

$$y(t) = H(j3)e^{j3t} = |H(j3)|e^{j[3t + \angle H(j3)]} = \frac{\sqrt{18}}{13} e^{j[3t - 67.62^\circ]}$$

4.7-3

$$H(j\omega) = \frac{-(j\omega - 10)}{j\omega + 10} = \frac{10 - j\omega}{10 + j\omega}$$

$$|H(j\omega)| = \sqrt{\frac{\omega^2 + 100}{\omega^2 + 100}} = 1$$

$$\angle H(j\omega) = \tan^{-1}\left(-\frac{\omega}{10}\right) - \tan^{-1}\left(\frac{\omega}{10}\right) = -2 \tan^{-1}\left(\frac{\omega}{10}\right)$$

(a)  $f(t) = e^{j\omega t}$

$$y(t) = H(j\omega)e^{j\omega t} = |H(j\omega)|e^{j[\omega t + \angle H(j\omega)]} = e^{j[\omega t - 2 \tan^{-1}(\omega/10)]}$$

(b)  $f(t) = \cos(\omega t + \theta)$

$$y(t) = \cos[\omega t + \theta - 2 \tan^{-1}\left(\frac{\omega}{10}\right)]$$

(c)  $f(t) = \cos t$ . Here  $\omega = 1$

$$|H(j1)| = 1$$

$$\angle H(j\omega) = -2 \tan^{-1}\left(\frac{1}{10}\right) = -11.42^\circ$$

$$y(t) = \cos(t - 11.42^\circ)$$

(d)  $f(t) = \sin 2t$ . Here  $\omega = 2$

$$|H(j2)| = 1$$

$$\angle H(j2) = -2 \tan^{-1}\left(\frac{2}{10}\right) = -22.62^\circ$$

$$y(t) = \sin(2t - 22.62^\circ)$$

(e)  $f(t) = \cos 10t$ . Here  $\omega = 10$

$$|H(j10)| = 1$$

$$\angle H(j10) = -2 \tan^{-1}\left(\frac{10}{10}\right) = -90^\circ$$

$$y(t) = \cos(10t - 90^\circ) = \sin 10t$$

(f)  $f(t) = \cos 100t$ . Here  $\omega = 100$

$$|H(j100)| = 1$$

$$\angle H(j100) = -2 \tan^{-1}\left(\frac{100}{10}\right) = -168.58^\circ$$

$$y(t) = \cos(100t - 168.58^\circ)$$

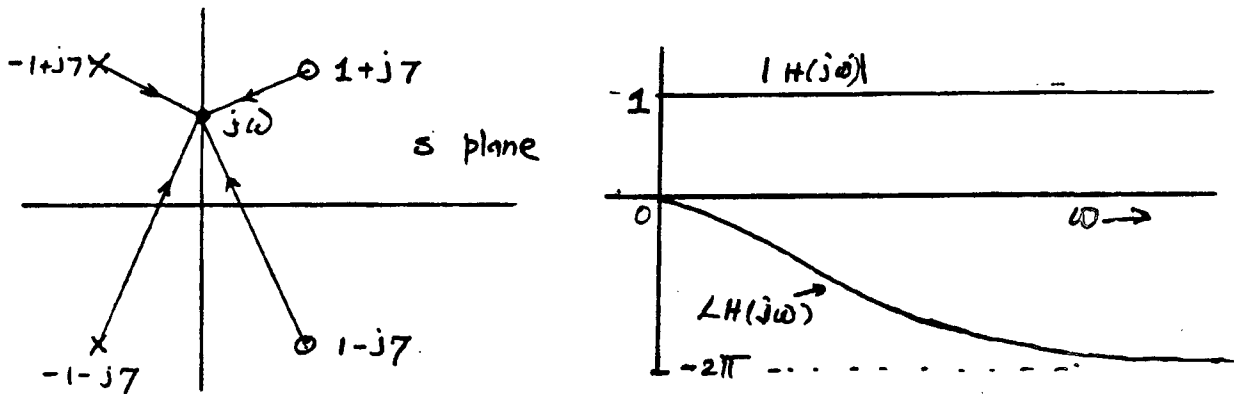

Fig. S4.7-5

4.7-5 We plot the poles  $-1 \pm j7$  and  $1 \pm j7$  in the  $s$ -plane. To find response at some frequency  $\omega$ , we connect all the poles and zeros to the point  $j\omega$  as shown in Fig. S4.7-5. Note that the product of distances from the zeros is equal to the product of the distances from the poles for all values of  $\omega$ . Therefore  $|H(j\omega)| = 1$ . Graphical argument shows that  $\angle H(j\omega)$  (sum of the angles from the zeros— sum of the angles from poles) starts at zero for  $\omega = 0$  and then reduces continuously (becomes negative) as  $\omega$  increases. As  $\omega \rightarrow \infty$ ,  $\angle H(\omega) \rightarrow -2\pi$ .

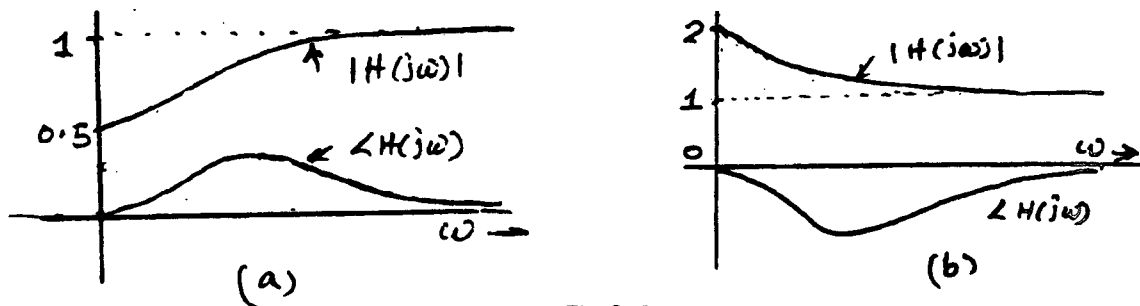

Fig. S4.7-6

4.7-6 (a) If  $r$  and  $d$  are the distances of the zero and pole, respectively from  $j\omega$ , then the amplitude response  $|H(j\omega)|$  is the ratio  $r/d$  corresponding to  $j\omega$ . This ratio is 0.5 for  $\omega = 0$ . Therefore, the dc gain is 0.5. Also the ratio  $r/d = 1$  for  $\omega = \infty$ . Thus, the gain is unity at  $\omega = \infty$ . Also the angles of the line segments connecting the zero

and pole to the point  $j\omega$  are both zero for  $\omega = 0$ , and are both  $\pi/2$  for  $\omega = \infty$ . Therefore  $\angle H(j\omega) = 0$  at  $\omega = 0$  and  $\omega = \infty$ . In between the angle is positive as shown in Fig. S4.7-6a.

(b) In this case the ratio  $r/d$  is 2 for  $\omega = 0$ . Therefore, the dc gain is 2. Also the ratio  $r/d = 1$  for  $\omega = \infty$ . Thus, the gain is unity at  $\omega = \infty$ . Also the angles of the line segments connecting the zero and pole to the point  $j\omega$  are both zero for  $\omega = 0$ , and are both  $\pi/2$  for  $\omega = \infty$ . Therefore  $\angle H(j\omega) = 0$  at  $\omega = 0$  and  $\omega = \infty$ . In between the angle is negative as shown in Fig. S4.7-6b.

4.7-7 The poles are at  $-a \pm j10$ . Moreover zero gain at  $\omega = 0$  and  $\omega = \infty$  requires that there be a single zero at  $s = 0$ . This clearly causes the gain to be zero at  $\omega = 0$ . Also because there is one excess pole over zero, the gain for large values of  $\omega$  is  $1/\omega$ , which approaches 0 as  $\omega \rightarrow \infty$ . therefore, the suitable transfer function is

$$H(s) = \frac{s}{(s+a+j10)(s+a-j10)} = \frac{s}{s^2+2as+(100+a^2)}$$

The amplitude response is high in the vicinity of  $\omega = 10$  provided  $a$  is small. Smaller the  $a$ , more pronounced the gain in the vicinity of  $\omega = 10$ . For  $a = 0$ , the gain at  $\omega = 10$  is  $\infty$ .

4.8-1 (a) Let  $f_1(t) = f(t)u(t) = e^t u(t)$  and  $f_2(t) = f(t)u(-t) = u(-t)$ . Then  $F_1(s)$  has a region of convergence  $\sigma > 1$ . And  $F_2(s)$  has a region  $\sigma < 0$ . Hence there is no common region of convergence for  $F(s) = F_1(s) + F_2(s)$ .

(b)  $f_1(t) = e^{-t} u(t)$ , and  $F_1(s) = \frac{1}{s+1}$  converges for  $\sigma > -1$ . Also  $f_2(t) = u(-t)$ , and  $F_2(s) = -\frac{1}{s}$  converges for  $\sigma < 0$ . Therefore, the strip of convergence is

$$-1 < \sigma < 0$$

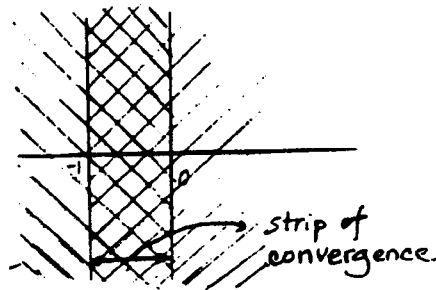

Figure S4.8-1b

(c)

$$\left. \begin{aligned} \frac{1}{t^2+1} e^{-st} \rightarrow 0 \end{aligned} \right\} \begin{aligned} &\text{as } t \rightarrow \infty \text{ if } \operatorname{Re} s \geq 0 \\ &\text{as } t \rightarrow -\infty \text{ if } \operatorname{Re} s \leq 0 \end{aligned}$$

Hence the convergence occurs at  $\sigma = 0$  ( $j\omega$ -axis)

(d)

$$f(t) = \frac{1}{1+e^t}$$

$$\left. \begin{aligned} \frac{1}{1+e^t} e^{-st} \rightarrow 0 \end{aligned} \right\} \begin{aligned} &\text{as } t \rightarrow \infty \text{ if } \operatorname{Re} s > -1 \\ &\text{as } t \rightarrow -\infty \text{ if } \operatorname{Re} s < 0 \end{aligned}$$

Hence the region of convergence is  $-1 < \sigma < 0$

(e)

$$f(t) = e^{-kt^2}$$

$$\left. \begin{aligned} e^{-kt^2} e^{-st} \rightarrow 0 \end{aligned} \right\} \begin{aligned} &\text{as } t \rightarrow \infty \text{ for any value of } s \\ &\text{as } t \rightarrow -\infty \text{ for any value of } s \end{aligned}$$

Hence the region of convergence is the entire  $s$ -plane.

4.8-2 (a)

$$f(t) = e^{-|t|} = e^{-t} u(t) + e^t u(-t) = f_1(t) + f_2(t)$$

$$F_1(s) = \frac{1}{s+1} \quad \sigma > -1$$

$$f_2(-t) = e^{-t}u(t) \quad \text{and} \quad F_2(-s) = \frac{1}{s+1}$$

$$\text{and} \quad F_2(s) = \frac{1}{-s+1} \quad \sigma < 1$$

$$\text{Hence: } F(s) = F_1(s) + F_2(s) = \frac{1}{s+1} + \frac{1}{-s+1} = \frac{-2}{s^2-1} \quad -1 < \sigma < 1$$

(b)

$$f(t) = e^{-|t|} \cos t = e^{-t} \cos t u(t) + e^t \cos t u(-t) = f_1(t) + f_2(t)$$

$$\text{Hence } F_1(s) = \frac{s+1}{(s+1)^2+1} \quad \text{and} \quad F_2(-s) = \frac{s+1}{(s+1)^2+1} \quad \sigma < 1$$

$$F(s) = F_1(s) + F_2(s) = \frac{s+1}{(s+1)^2+1} - \frac{s-1}{(s-1)^2+1} = \frac{4-2s^2}{s^4-4} \quad -1 < \sigma < 1$$

(c)

$$f(t) = e^t u(t) + e^{2t} u(-t); \quad F_1(s) = \frac{1}{s-1} \quad \sigma > 1 \quad \text{and} \quad F_2(-s) = \frac{1}{s+2}$$

$$F_2(s) = \frac{1}{-s+2} \quad \sigma < 2.$$

$$\text{Hence } F(s) = F_1(s) + F_2(s) = \frac{-1}{(s-1)(s-2)} \quad 1 < \sigma < 2$$

(d)

$$f(t) = \cos \omega_0 t u(t) + e^t u(-t) = f_1(t) + f_2(t)$$

$$F_1(s) = \frac{s}{s^2 + \omega_0^2} \quad \sigma > 0$$

$$\text{and} \quad F_2(-s) = \frac{1}{s+1}, \quad F_2(s) = \frac{1}{1-s} \quad \sigma < 1$$

$$F(s) = F_1(s) + F_2(s) = \frac{-(s + \omega_0^2)}{(s-1)(s^2 + \omega_0^2)} \quad 0 < \sigma < 1$$

(e)

$$f(t) = e^{-t}u(t) = \begin{cases} e^{-t} & \text{for } t > 0 \\ 1 & \text{for } t < 0 \end{cases}$$

$$f_1(t) = e^{-t}u(t), \quad f_2(t) = u(-t). \quad \text{Hence } F_1(s) = \frac{1}{s+1} \quad \sigma > -1$$

$$\text{and } F_2(-s) = \frac{1}{s}, \quad F_2(s) = \frac{-1}{s} \quad \sigma < 0$$

$$\text{and hence: } F(s) = \frac{1}{s+1} - \frac{1}{s} = \frac{-1}{s(s+1)} \quad -1 < \sigma < 0$$

(f)

$$f(t) = e^{tu(-t)} = \begin{cases} f_1(t) = 1 & \text{for } t > 0 \\ f_2(t) = e^t & \text{for } t < 0 \end{cases}$$

$$F_1(s) = \frac{1}{s} \quad \sigma > 0$$

$$F_2(-s) = \frac{1}{s+1}, \quad F_2(s) = \frac{1}{-s+1} \quad \sigma < 1$$

$$\text{and hence: } F(s) = \frac{1}{s} - \frac{1}{s-1} = \frac{-1}{s(s-1)} \quad 0 < \sigma < 1$$

(b)  $\text{Re } s < -2$ : All poles to the right of the region of convergence. Therefore

$$f(t) = (-e^{-t} + e^t - 2e^{-2t})u(-t)$$

(c)  $-1 < \text{Re } s < 1$ : Poles  $-1$  and  $-2$  to the left and pole  $1$  to the right of the region of convergence. Therefore

$$f(t) = (e^{-t} + 2e^{-2t})u(t) + e^t u(-t)$$

(d)  $-2 < \text{Re } s < -1$ : Poles  $-1$  and  $1$  are to the right and pole  $-2$  is to the left of the region of convergence. Therefore

$$f(t) = 2e^{-2t}u(t) + [-e^{-t} + e^t]u(-t)$$

4.8-5 (a)

$$f(t) = e^{-\frac{|t|}{2}}, \quad H(s) = \frac{1}{s+1} \quad \sigma > -1$$

$$\text{And } F(s) = \frac{1}{s+0.5} - \frac{1}{s-0.5} \quad -\frac{1}{2} < \sigma < \frac{1}{2}$$

$$\text{hence: } Y(s) = H(s)F(s) = \frac{1}{s+1} \left[ \frac{1}{s+0.5} - \frac{1}{s-0.5} \right] \quad -\frac{1}{2} < \sigma < \frac{1}{2}$$

$$\begin{aligned} Y(s) &= \frac{-2}{s+1} + \frac{2}{s+0.5} + \frac{\frac{2}{3}}{s+1} - \frac{\frac{2}{3}}{s-0.5} \\ &= \frac{-\frac{4}{3}}{s+1} + \frac{2}{s+0.5} - \frac{\frac{2}{3}}{s-0.5} \quad -\frac{1}{2} < \sigma < \frac{1}{2} \end{aligned}$$

The poles  $-1$  and  $-0.5$ , which are to the left of the strip of convergence, yield the causal signal, and the pole  $0.5$ , which is to the right of the strip of convergence, yields the anticausal signal. Hence

$$y(t) = \left(-\frac{4}{3}e^{-t} + 2e^{-t/2}\right)u(t) + \frac{2}{3}e^{t/2}u(-t)$$

(b)

$$f(t) = e^t u(t) + e^{2t} u(-t)$$

$$\begin{aligned} F(s) &= \frac{1}{s-1} - \frac{1}{s-2} \quad 1 < \sigma < 2 \\ &= \frac{-1}{(s-1)(s-2)} \end{aligned}$$

$$\text{And } H(s) = \frac{1}{s+1} \quad \sigma > -1$$

$$\text{Hence: } Y(s) = H(s)F(s) = \frac{-1}{(s+1)(s-1)(s-2)} \quad 1 < \sigma < 2$$

$$Y(s) = \frac{-1/6}{s+1} + \frac{1/2}{s-1} - \frac{1/3}{s-2} \quad 1 < \sigma < 2$$

$$\text{Hence } y(t) = \left(-\frac{1}{6}e^{-t} + \frac{1}{2}e^t\right)u(t) + \frac{1}{3}e^{2t}u(-t)$$

(c)

$$f(t) = e^{-t/2}u(t) + e^{-t/4}u(-t)$$

$$F(s) = \frac{1}{s+0.5} - \frac{1}{s+0.25} = \frac{-\frac{1}{4}}{(s+0.5)(s+0.25)} \quad -\frac{1}{2} < \sigma < \frac{1}{4}$$

$$\text{Also } H(s) = \frac{1}{s+1} \quad \sigma > -1$$



$$\begin{aligned} \text{Hence: } Y(s) = H(s)F(s) &= \frac{-\frac{1}{4}}{(s+1)(s+0.5)(s+0.25)} & -\frac{1}{2} < \sigma < \frac{1}{4} \\ &= \frac{-\frac{3}{4}}{s+1} + \frac{2}{s+0.5} - \frac{\frac{1}{4}}{s+0.25} & -\frac{1}{2} < \sigma < \frac{1}{4} \end{aligned}$$

$$\text{and } y(t) = \left(-\frac{3}{4}e^{-t} + 2e^{-\frac{t}{2}}\right) u(t) + \frac{1}{4}e^{-\frac{t}{4}}u(-t)$$

(d)

$$f(t) = e^{2t}u(t) + e^t u(-t) = f_1(t) + f_2(t)$$

$$F_1(s) = \frac{1}{s-2} \quad \sigma > 2$$

$$F_2(s) = \frac{-1}{s-1} \quad \sigma < 1$$

$$\text{and } H(s) = \frac{1}{s+1} \quad \sigma > -1$$

In this case, there is no region of convergence that is common to  $F_1(s)$  and  $F_2(s)$ . However, each of  $F_1(s)$  and  $F_2(s)$  have a region of convergence that is common to  $H(s)$ . Hence the output can be computed by finding the system response to  $f_1(t)$  and  $f_2(t)$  separately, and then adding these two components. This means we need not worry about the common region of convergence for  $F_1(s)$  and  $F_2(s)$ . Thus:

$$Y(s) = Y_1(s) + Y_2(s) \quad \text{where}$$

$$\begin{aligned} Y_1(s) = F_1(s)H(s) &= \frac{1}{(s+1)(s-2)} & \sigma > 2 \\ &= \frac{-\frac{1}{3}}{s+1} + \frac{\frac{1}{3}}{s-2} & \sigma > 2 \end{aligned}$$

Observe that both the poles (-1 and 2) are to the left of the region of convergence, hence both terms are causal, and:

$$y_1(t) = \left(-\frac{1}{3}e^{-t} + \frac{1}{3}e^{2t}\right) u(t)$$

$$\begin{aligned} Y_2(s) = F_2(s)H(s) &= \frac{-1}{(s+1)(s-1)} & -1 < \sigma < 1 \\ &= \frac{\frac{1}{2}}{s+1} - \frac{\frac{1}{2}}{s-1} & -1 < \sigma < 1 \end{aligned}$$

The poles -1 and 1 are to the left and the right, respectively, of the strip of convergence. Hence the first term yields causal signal and the second yields anticausal signal. Hence

$$y_2(t) = -\frac{1}{2}e^{-t}u(t) + \frac{1}{2}e^t u(-t)$$

$$\text{Therefore } y(t) = y_1(t) + y_2(t) = \left(\frac{1}{3}e^{-t} + \frac{1}{3}e^{2t}\right) u(t) + \frac{1}{2}e^t u(-t)$$

(e)

$$f(t) = e^{-\frac{t}{4}}u(t) + e^{-\frac{t}{2}}u(-t) = f_1(t) + f_2(t)$$

$$F(s) = F_1(s) + F_2(s)$$

$$\begin{aligned} \text{where } F_1(s) &= \frac{1}{s+0.25} & \sigma > -\frac{1}{4} \\ F_2(s) &= \frac{-1}{s+0.5} & \sigma < -\frac{1}{2} \\ H(s) &= \frac{1}{s+1} & \sigma > -1 \end{aligned}$$

Here also, we have no common region of convergence, for  $F_1(s)$  and  $F_2(s)$  as in part d. Let  $Y(s) = Y_1(s) + Y_2(s)$  where:

$$\begin{aligned} Y_1(s) &= \frac{1}{(s+1)(s+0.25)} & \sigma > -\frac{1}{4} \\ &= \frac{-\frac{4}{3}}{s+1} + \frac{\frac{4}{3}}{s+0.25} & \sigma > -\frac{1}{4} \end{aligned}$$

$$y_1(t) = \left( -\frac{4}{3}e^{-t} + \frac{4}{3}e^{-\frac{t}{2}} \right) u(t)$$

$$\begin{aligned} Y_2(s) &= \frac{-1}{(s+1)(s+0.5)} & -1 < \sigma < -\frac{1}{2} \\ &= \frac{2}{s+1} - \frac{2}{s+0.5} & -1 < \sigma < -\frac{1}{2} \end{aligned}$$

$$\text{and } y_2(t) = 2e^{-t}u(t) + 2e^{-\frac{t}{2}}u(-t)$$

$$\text{Hence } y(t) = y_1(t) + y_2(t) = \left( \frac{2}{3}e^{-t} + \frac{4}{3}e^{-\frac{t}{2}} \right) u(t) + 2e^{-\frac{t}{2}}u(-t)$$

(f)

$$f(t) = e^{-3t}u(t) + e^{-2t}u(-t) = f_1(t) + f_2(t)$$

$$F(s) = F_1(s) + F_2(s)$$

$$\begin{aligned} \text{where } F_1(s) &= \frac{1}{s+3} & \sigma > -3 \\ F_2(s) &= \frac{-1}{s+2} & \sigma < -2 \\ H(s) &= \frac{1}{s+1} & \sigma > -1 \end{aligned}$$

In this case, there is a common region of convergence for  $F_1(s)$  and  $H(s)$ , but there is no region of convergence common to  $F_2(s)$  and  $H(s)$ . Hence the output  $y_1(t)$  will be finite but  $y_2(t)$  will be  $\infty$ .

## Chapter 5

---

5.1-1 (a)

$$\begin{aligned}
 F[z] &= \sum_{k=1}^{\infty} \gamma^{k-1} z^{-k} = \frac{1}{\gamma} \sum_{k=1}^{\infty} \left(\frac{\gamma}{z}\right)^k & (1) \\
 &= \frac{1}{\gamma} \left[ \frac{\gamma}{z} + \left(\frac{\gamma}{z}\right)^2 + \left(\frac{\gamma}{z}\right)^3 + \dots \right] \\
 &= \frac{1}{\gamma} \left[ -1 + \left(1 + \frac{\gamma}{z} + \left(\frac{\gamma}{z}\right)^2 + \left(\frac{\gamma}{z}\right)^3 + \dots\right) \right] \\
 &= \frac{1}{\gamma} \left[ -1 + \frac{1}{1 - \frac{\gamma}{z}} \right] = \frac{1}{z - \gamma}
 \end{aligned}$$

(b)

$$\begin{aligned}
 F[z] &= \sum_{k=m}^{\infty} z^{-k} = z^{-m} + z^{-(m+1)} + z^{-(m+2)} + \dots \\
 &= z^{-m} \left[ 1 + \frac{1}{z} + \frac{1}{z^2} + \dots \right] \\
 &= z^{-m} \left( \frac{1}{1 - \frac{1}{z}} \right) = \frac{z}{z^m(z-1)}
 \end{aligned}$$

(c)

$$F[z] = \sum_{k=0}^{\infty} \frac{\gamma^k}{k!} z^{-k} = \sum_{k=0}^{\infty} \frac{1}{k!} \left(\frac{\gamma}{z}\right)^k$$

Recall that

$$e^x = \sum_{k=0}^{\infty} \frac{1}{k!} x^k$$

Therefore

$$F[z] = e^{\gamma/z}$$

(d)

$$F[z] = \sum_{k=0}^{\infty} \frac{1}{k!} (\ln \alpha)^k z^{-k} = \sum_{k=0}^{\infty} \frac{1}{k!} \left(\frac{\ln \alpha}{z}\right)^k$$

From the result in part (c) it follows that

$$F[z] = e^{\ln \alpha / z} = (e^{\ln \alpha})^{1/z} = \alpha^{1/z}$$

5.1-2 (a)

$$f[k] = (2)^{k+1} u[k-1] + (e)^{k-1} u[k] = 4(2)^{k-1} u[k-1] + \frac{1}{e}(e)^k u[k]$$

Therefore

$$F[z] = \frac{4}{z-2} + \frac{1}{e} \frac{z}{z-e}$$

(b)

$$f[k] = k\gamma^k u[k-1] = k\gamma^k u[k] - 0 = k\gamma^k u[k]$$

Therefore

$$F[z] = \frac{\gamma z}{(z - \gamma)^2}$$

(c)

$$f[k] = [(2)^{-k} \cos \frac{\pi k}{3}] u[k-1] = (2)^{-k} \cos \frac{\pi k}{3} u[k] - \delta[k]$$

Therefore

$$F[z] = \frac{z(z-0.25)}{z^2 - 0.5z + 0.25} - 1 = \frac{0.25(z-1)}{z^2 - 0.5z + 0.25}$$

(d) Because  $k(k-1)(k-2) = 0$  for  $k = 0, 1,$  and  $2$

$$f[k] = k(k-1)(k-2)2^{k-3} u[k-m] = k(k-1)(k-2)(2)^{k-3} u[k]$$

$k = 0, 1,$  or  $2$ . Therefore

$$f[k] = (2)^{-3} \{k(k-1)(k-2)2^k u[k]\}$$

and

$$F[z] = (2)^{-3} \left[ \frac{3!(2)^3 z}{(z-2)^4} \right] = \frac{6z}{(z-2)^4}$$

5.1-3 (a)

$$\frac{F[z]}{z} = \frac{z-4}{(z-2)(z-3)} = \frac{2}{z-2} - \frac{1}{z-3}$$

$$F[z] = 2 \frac{z}{z-2} - \frac{z}{z-3}$$

$$f[k] = [2(2)^k - (3)^k] u[k]$$

(b)

$$\frac{F[z]}{z} = \frac{z-4}{z(z-2)(z-3)} = \frac{-2/3}{z} + \frac{1}{z-2} - \frac{1/3}{z-3}$$

$$F[z] = -\frac{2}{3} + \frac{z}{z-2} - \frac{1}{3} \frac{z}{z-3}$$

$$f[k] = -\frac{2}{3} \delta[k] + \left[ (2)^k - \frac{1}{3}(3)^k \right] u[k]$$

(c)

$$\frac{F[z]}{z} = \frac{e^{-2} - 2}{(z - e^{-2})(z - 2)} = \frac{1}{z - e^{-2}} - \frac{1}{z - 2}$$

$$F[z] = \frac{z}{z - e^{-2}} - \frac{z}{z - 2}$$

$$f[k] = [e^{-2k} - 2^k] u[k]$$

(d)

$$\frac{F[z]}{z} = \frac{2z+3}{(z-1)(z-2)(z-3)} = \frac{5/2}{z-1} - \frac{7}{z-2} + \frac{9/2}{z-3}$$

$$F[z] = \frac{5}{2} \frac{z}{z-1} - 7 \frac{z}{z-2} + \frac{9}{2} \frac{z}{z-3}$$

$$f[k] = \left[ \frac{5}{2} - 7(2)^k + \frac{9}{2}(3)^k \right] u[k]$$

(e)

$$\frac{F[z]}{z} = \frac{-5z+22}{(z+1)(z-2)^2} = \frac{3}{z+1} + \frac{k}{z-2} + \frac{4}{(z-2)^2}$$

Multiply both sides by  $z$  and let  $z \rightarrow \infty$ . This yields

$$0 = 3 + k + 0 \implies k = -3$$

$$F[z] = 3\frac{z}{z+1} - 3\frac{z}{z-2} + 4\frac{z}{(z-2)^2}$$

$$f[k] = [3(-1)^k - 3(2)^k + 2k(2)^k] u[k]$$

(f)

$$\frac{F[z]}{z} = \frac{1.4z + 0.08}{(z-0.2)(z-0.8)^2} = \frac{1}{z-0.2} + \frac{k}{z-0.8} + \frac{2}{(z-0.8)^2}$$

Multiply both sides by  $z$  and let  $z \rightarrow \infty$ . This yields

$$0 = 1 + k \implies k = -1$$

$$F[z] = \frac{z}{z-0.2} - \frac{z}{z-0.8} + 2\frac{z}{(z-0.8)^2}$$

$$f[k] = [(0.2)^k - (0.8)^k + \frac{1}{2}k(0.8)^k] u[k]$$

(g) We use pair 12c with  $A = 1$ ,  $B = -2$ ,  $a = -0.5$ ,  $|\gamma| = 1$ . Therefore

$$r = \sqrt{4} = 2 \quad \beta = \cos^{-1}\left(\frac{0.5}{1}\right) = \frac{\pi}{3} \quad \theta = \tan^{-1}\left(\frac{1}{\sqrt{3}}\right) = 1.047$$

$$f[k] = 2(1)^k \cos\left(\frac{\pi k}{3} + 1.047\right) u[k] = 2 \cos\left(\frac{\pi k}{3} + 1.047\right) u[k]$$

(h)

$$\frac{F[z]}{z} = \frac{2z^2 - 0.3z + 0.25}{z(z^2 + 0.6z + 0.25)} = \frac{1}{z} + \frac{Az + B}{z^2 + 0.6z + 0.25}$$

Multiply both sides by  $z$  and let  $z \rightarrow \infty$ . This yields

$$2 = 1 + A \implies A = 1$$

Setting  $z = 1$  on both sides yields

$$\frac{1.95}{1.85} = 1 + \frac{1+B}{1.85} \implies B = -0.9$$

$$F[z] = 1 + \frac{z(x-0.9)}{z^2 + 0.6z + 0.25}$$

For the second fraction on right side, we use pair 12c with  $A = 1$ ,  $B = -0.9$ ,  $a = 0.3$ , and  $|\gamma| = 0.5$ . This yields

$$r = \sqrt{10} \quad \beta = \cos^{-1}\left(\frac{-0.3}{0.5}\right) = 2.214 \quad \theta = \tan^{-1}\left(\frac{1.2}{0.4}\right) = 1.249$$

$$f[k] = \delta[k] + \sqrt{10}(0.5)^k \cos(2.214k + 1.249) u[k]$$

(i)

$$\frac{F[z]}{z} = \frac{2(3z-23)}{(z-1)(z^2-6z+25)} = \frac{-2}{z-1} + \frac{Az+B}{z^2-6z+25}$$

Multiply both sides by  $z$  and let  $z \rightarrow \infty$ . This yields

$$0 = -2 + A \implies A = 2$$

Set  $z = 0$  on both sides to obtain

$$\frac{46}{25} = 2 + \frac{B}{25} \implies B = -4$$

$$F[z] = -2 + \frac{z}{z-1} + \frac{z(2z-4)}{z^2-6z+25}$$

For the second fraction on the right-hand side, we use pair 12c with  $A = 2$ ,  $B = -4$ ,  $a = -3$ , and  $|\gamma| = 5$ .

$$r = \frac{\sqrt{41}}{5} \quad \beta = \cos^{-1}\left(\frac{3}{5}\right) = 0.927 \quad \theta = \tan^{-1}\left(\frac{-1}{4}\right) = -0.25$$

$$f[k] = \left[ -2 + \frac{\sqrt{17}}{2}(5)^k \cos(0.927k - 0.25) \right] u[k]$$

(j)

$$\frac{F[z]}{z} = \frac{3.83z + 11.34}{(z-2)(z^2 - 5z + 25)} = \frac{1}{z-2} + \frac{Az + B}{z^2 - 5z + 25}$$

Multiply both sides by  $z$  and let  $z \rightarrow \infty$ . This yields

$$0 = 1 + A \implies A = -1$$

Setting  $z = 0$  on both sides yields

$$\frac{11.34}{-30} = -\frac{1}{2} + \frac{B}{25} \implies B = 6.83$$

$$F[z] = \frac{z}{z-2} + \frac{z(-z + 6.83)}{z^2 - 5z + 25}$$

For the second fraction on right-hand side, use pair 12c with  $A = -1$ ,  $B = 6.83$ ,  $a = -2.5$ , and  $|\gamma| = 5$ .

$$r = \sqrt{2} \quad \beta = \cos^{-1}(0.5) = \frac{\pi}{3} \quad \theta = \tan^{-1}\left(\frac{-4.33}{-4.33}\right) = -\frac{3\pi}{4}$$

$$f[k] = \left[ (2)^k + \sqrt{2}(5)^k \cos\left(\frac{\pi}{3}k - \frac{3\pi}{4}\right) \right] u[k]$$

(k)

$$\frac{F[z]}{z} = \frac{z(-2z^2 + 8z - 7)}{(z-1)(z-2)^3} = \frac{1}{z-1} + \frac{k_1}{z-2} + \frac{k_2}{(z-2)^2} + \frac{2}{(z-2)^3}$$

Multiply both sides by  $z$  and let  $z \rightarrow \infty$ . This yields

$$-2 = 1 + k_1 \implies k_1 = -3$$

Set  $z = 0$  on both sides to obtain

$$0 = -1 + \frac{3}{2} + \frac{k_2}{4} - \frac{1}{4} \implies k_2 = -1$$

$$F[z] = \frac{z}{z-1} - 3\frac{z}{z-2} - \frac{z}{(z-2)^2} + 2\frac{z}{(z-2)^3}$$

$$f[k] = \left[ 1 - 3(2)^k - \frac{1}{2}(2)^k + \frac{1}{4}k(k-1)(2)^k \right] u[k]$$

5.1-4 Long division of  $2z^3 + 13z^2 + z$  by  $z^3 + 7z^2 + 2z + 1$  yields

$$F[z] = 2 - \frac{1}{z} + \frac{4}{z^2} + \dots$$

Therefore  $f[0] = 2$ ,  $f[1] = -1$ ,  $f[2] = 4$ .

5.1-5

$$F[z] = \frac{\gamma z}{z^2 - 2\gamma z + \gamma^2}$$

Long division yields

$$\frac{\gamma z}{z^2 - 2\gamma z + \gamma^2} = \frac{\gamma}{z} + 2\left(\frac{\gamma}{z}\right)^2 + 3\left(\frac{\gamma}{z}\right)^3 + \dots$$

Therefore  $f[0] = 0$ ,  $f[1] = \gamma$ ,  $f[2] = 2\gamma^2$ ,  $f[3] = 3\gamma^3, \dots$ , and

$$f[k] = k\gamma^k u[k]$$

5.2-1

$$f[k] = u[k] - u[k-m]$$

$$F[z] = \frac{z}{z-1} - z^{-m} \frac{z}{z-1} = \frac{1 - z^{-m}}{1 - z^{-1}}$$

5.2-2

$$f[k] = \delta[k-1] + 2\delta[k-2] + 3\delta[k-3] + 4\delta[k-4] + 3\delta[k-5] + 2\delta[k-6] + \delta[k-7]$$

Therefore

$$\begin{aligned} F[z] &= \frac{1}{z} + \frac{2}{z^2} + \frac{3}{z^3} + \frac{4}{z^4} + \frac{3}{z^5} + \frac{2}{z^6} + \frac{1}{z^7} \\ &= \frac{z^6 + 2z^5 + 3z^4 + 4z^3 + 3z^2 + 2z + 1}{z^7} \end{aligned}$$

Alternate Method:

$$\begin{aligned} f[k] &= k\{u[k] - u[k-5]\} + (-k+8)\{u[k-5] - u[k-9]\} \\ &= ku[k] - 2ku[k-5] + ku[k-9] + 8u[k-5] - 8u[k-9] \\ &= ku[k] - 2\{(k-5)u[k-5] + 5u[k-5]\} + (k-9)u[k-9] + 9u[k-9] + 8u[k-5] - 8u[k-9] \\ &= ku[k] - 2(k-5)u[k-5] + (k-9)u[k-9] - 2u[k-5] + u[k-9] \end{aligned}$$

Therefore

$$\begin{aligned} F[z] &= \frac{z}{(z-1)^2} - \frac{2z}{z^5(z-1)^2} + \frac{z}{z^9(z-1)^2} - \frac{2z}{z^5(z-1)} + \frac{z}{z^9(z-1)} \\ &= \frac{z}{z^9(z-1)^2} [z^9 - 2z^4 + 1 - 2z^4(z-1) + (z-1)] \\ &= \frac{1}{z^7(z-1)^2} [z^9 - 2z^4 + 1] \end{aligned}$$

Reader may verify that the two answers are identical.

5.2-3 (a)

$$f[k] = k^2 \gamma^k u[k]$$

Repeated application of Eq. (5.25) to  $\gamma^k u[k] \iff \frac{z}{z-\gamma}$  yields

$$\begin{aligned} k\gamma^k u[k] &\iff \frac{\gamma z}{(z-\gamma)^2} \\ k^2 \gamma^k u[k] &\iff \frac{\gamma z(z+\gamma)}{(z-\gamma)^3} \end{aligned}$$

(b) Application of Eq. (5.25) to  $k^2 \gamma^k u[k] \iff \frac{\gamma z(z+\gamma)}{(z-\gamma)^3}$  (found in part a) yields

$$k^3 \gamma^k u[k] = -z \frac{d}{dz} \left[ \frac{\gamma z(z+\gamma)}{(z-\gamma)^3} \right] = \frac{\gamma z(z^2 + 4\gamma z + \gamma^2)}{(z-\gamma)^3}$$

Now setting  $\gamma = 1$  in this result yields

$$k^3 u[k] = \frac{z(z^2 + 4z + 1)}{(z-1)^3}$$

(c)

$$\begin{aligned} f[k] &= a^k \{u[k] - u[k-m]\} \\ &= a^k u[k] - a^m a^{k-m} u[k-m] \\ F[z] &= \frac{z}{z-a} - \frac{a^m z}{z-a} z^{-m} = \frac{z}{z-a} \left[ 1 - \left(\frac{a}{z}\right)^m \right] \end{aligned}$$

(d)

$$\begin{aligned} f[k] &= ke^{-2k} u[k-m] = (k-m+m)e^{-2(k-m+m)} u[k-m] \\ &= e^{-2m}(k-m)e^{-2(k-m)} u[k-m] + me^{-2m}e^{-2(k-m)} u[k-m] \\ F[z] &= e^{-2m} \frac{e^{-2z}}{(z-e^{-2})^2} z^{-2} + me^{-2m} \left( \frac{z}{z-e^{-2}} \right) z^{-2} \\ &= \frac{e^{-2m}}{z(z-e^{-2})^2} \left[ \frac{1}{z^2}(1-m) + mz \right] \end{aligned}$$

5.2-4 Pair2:

$$u[k] = \delta[k] + \delta[k-1] + \delta[k-2] + \delta[k-3] + \dots$$

$$u[k] \longleftrightarrow 1 + \frac{1}{z} + \frac{1}{z^2} + \frac{1}{z^3} + \dots = \frac{1}{1 - \frac{1}{z}} = \frac{z}{z-1}$$

Repeated application of Eq. (5.25) to pair 2 yields pair 3, 4, and 5.

Application of Eq. (5.24) to pair 2 yields pair 7, and application of time-delay (5.19a) to pair 7 yields pair 6.

Repeated application of Eq. (5.25) to pair 7 yields pair 8 and 9.

5.3-1

$$y[k+1] - \gamma y[k] = f[k+1]$$

with  $y[0] = -M$ ,  $f[k] = Pu[k-1]$

$$F[z] = \frac{Pz}{z-1}$$

$$y[k] \longleftrightarrow Y[z] \quad y[k+1] \longleftrightarrow zY[z] + Mz$$

The  $z$ -transform of the system equation is

$$\begin{aligned} zY[z] + Mz - \gamma Y[z] &= \frac{Pz}{z-1} \\ (z-\gamma)Y[z] &= -M + \frac{Pz}{z-1} \end{aligned}$$

and

$$\begin{aligned} Y[z] &= \frac{-Mz}{z-\gamma} + \frac{Pz}{(z-\gamma)(z-1)} \\ \frac{Y[z]}{z} &= \frac{-M}{z-\gamma} + \frac{P}{(z-\gamma)(z-1)} = \frac{-M}{z-\gamma} + \frac{P}{\gamma-1} \left[ \frac{1}{z-\gamma} - \frac{1}{z-1} \right] \\ Y[z] &= -M \frac{z}{z-\gamma} + \frac{P}{\gamma-1} \left[ \frac{z}{z-\gamma} - \frac{z}{z-1} \right] \\ y[k] &= \left[ -M\gamma^k + \frac{P(\gamma^k-1)}{\gamma} \right] u[k] \quad r = \gamma - 1 \end{aligned}$$

The loan balance is zero for  $k = N$ , that is,  $y[N] = 0$ . Setting  $k = N$  in the above equation we obtain

$$y[N] = \left[ -M\gamma^N + \frac{P(\gamma^N-1)}{\gamma} \right] = 0$$

This yields

$$P = \frac{r\gamma^N}{\gamma^N - 1} M$$

5.3-2 The  $z$ -transform of the equation yields

$$zY[z] - z + 2Y[z] = zF[z] - zf(0)$$

$$f[k] = ce^{-k}u[k] \quad \text{and} \quad F[z] = \frac{cz}{z-e^{-1}}, \quad f[0] = c$$

Therefore

$$\begin{aligned} (z+2)Y[z] &= z - cz + \frac{cz^2}{z-e^{-1}} = \frac{z(1-e)(z-e^{-1}) + cz^2}{z-e^{-1}} \\ \frac{Y[z]}{z} &= \frac{z+1-e^{-1}}{(z+2)(z-e^{-1})} = \frac{1}{2e+1} \left[ \frac{e+1}{z+2} + \frac{c}{z-e^{-1}} \right] \\ Y[z] &= \frac{1}{2e+1} \left[ (e+1) \frac{z}{z+2} + c \frac{z}{z-e^{-1}} \right] \\ y[k] &= \frac{1}{2e+1} \left[ (e+1)(-2)^k + e^{-(k-1)} \right] u[k] \end{aligned}$$



5.3-3 The system equation in delay form is

$$2y[k] - 3y[k-1] + y[k-2] = 4f[k] - 3f[k-1]$$

Also

$$\begin{aligned} y[k] &\leftrightarrow Y[z] & y[k-1] &\leftrightarrow \frac{1}{z}Y[z] & y[k-2] &\leftrightarrow \frac{1}{z^2}Y[z] + 1 \\ f[k] &\leftrightarrow F[z] = \frac{z}{z-0.25} & f[k-1] &\leftrightarrow \frac{1}{z-0.25} \end{aligned}$$

The  $z$ -transform of the equation is

$$2Y[z] - \frac{3}{z}Y[z] + \frac{1}{z^2}Y[z] + 1 = \frac{4z}{z-0.25} - \frac{3}{z-0.25} = \frac{4z-3}{z-0.25}$$

or

$$\left(2 - \frac{3}{z} + \frac{1}{z^2}\right)Y[z] = -1 + \frac{4z-3}{z-0.25} = \frac{3z-2.75}{z-0.25}$$

and

$$\begin{aligned} \frac{Y[z]}{z} &= \frac{z(3z-2.75)}{(2z^2-3z+1)(z-0.25)} = \frac{z(3z-2.75)}{2(z-0.5)(z-1)(z-0.25)} = \frac{5/2}{z-1/2} + \frac{1/3}{z-1} - \frac{4/3}{z-0.25} \\ y[k] &= \left[\frac{5}{2} + \frac{1}{2}(0.5)^k - \frac{4}{3}(0.25)^k\right] u[k] = \left[\frac{5}{2} + \frac{1}{2}(2)^{-k} - \frac{4}{3}(4)^{-k}\right] u[k] \end{aligned}$$

5.3-4 For initial conditions  $y[0], y[1]$ , we require equation in advance form:

$$2y[k+2] - 3y[k+1] + y[k] = 4f[k+2] - 3f[k+1]$$

Also

$$\begin{aligned} y[k] &\leftrightarrow Y[z] & y[k+1] &\leftrightarrow zY[z] - \frac{3}{2}z & y[k+2] &\leftrightarrow z^2Y[z] - \frac{3}{2}z^2 - \frac{35}{4}z \\ f[k] &\leftrightarrow F[z] = \frac{z}{z-0.25} & f[k+1] &\leftrightarrow zF[z] - z = \frac{0.25z}{z-0.25} \end{aligned}$$

and

$$f[k+2] \leftrightarrow z^2F[z] - z^2 - \frac{1}{4}z = \frac{z}{16(z-0.25)}$$

The  $z$ -transform of the equation is

$$2\left[z^2Y[z] - \frac{3}{2}z^2 - \frac{35}{4}z\right] - 3\left[zY[z] - \frac{3}{2}z\right] + Y[z] = \frac{-z/2}{z-0.25}$$

or

$$(2z^2 - 3z + 1)Y[z] = \frac{z(3z^2 + 12.25z - 3.75)}{(z-0.25)}$$

and

$$\begin{aligned} \frac{Y[z]}{z} &= \frac{3z^2 + 12.25z - 3.75}{2(z-0.25)(z-1)(z-0.5)} = \frac{46/3}{z-1} - \frac{4/3}{z-0.25} - \frac{25/2}{z-0.5} \\ Y[z] &= \frac{46}{3} \frac{z}{z-1} - \frac{4}{3} \frac{z}{z-0.25} - \frac{25}{2} \frac{z}{z-0.5} \\ y[k] &= \left[\frac{46}{3} - \frac{4}{3}(0.25)^k - \frac{25}{2}(0.5)^k\right] u[k] \end{aligned}$$

5.3-5 System equation in delay form is

$$4y[k] + 4y[k-1] + y[k-2] = f[k-1]$$

Also

$$\begin{aligned} y[k] &\leftrightarrow Y[z] & y[k-1] &\leftrightarrow \frac{1}{z}Y[z] & y[k-2] &\leftrightarrow \frac{1}{z^2}Y[z] + 1 \\ f[k] &\leftrightarrow \frac{z}{z-1} & f[k-1] &\leftrightarrow \frac{1}{z-1} & (f[-1] &= 0) \end{aligned}$$

The  $z$ -transform of the system equation is

$$4Y[z] + \frac{4}{z}Y[z] + \frac{1}{z^2}Y[z] + 1 = \frac{1}{z-1}$$

$$\frac{4z^2 + 4z + 1}{z^2}Y[z] = \frac{2-z}{z-1}$$

and

$$\frac{Y[z]}{z} = \frac{z(2-z)}{4(z-1)(z^2+z+0.25)} = \frac{z(2-z)}{4(z-1)(z+0.5)^2} = \frac{1}{4} \left[ \frac{4/9}{z-1} - \frac{13/9}{z+0.5} + \frac{5/6}{(z+0.5)^2} \right]$$

$$Y[z] = \frac{1}{4} \left[ \frac{4}{9} \frac{z}{z-1} - \frac{13}{9} \frac{z}{z+0.5} + \frac{5}{6} \frac{z}{(z+0.5)^2} \right]$$

$$y[k] = \left[ \frac{1}{9} - \frac{13}{36}(-0.5)^k - \frac{5}{12}k(-0.5)^k \right] u[k]$$

5.3-6 The system in delay form is

$$y[k] - 3y[k-1] + 2y[k-2] = f[k-1]$$

Also

$$y[k] \iff Y[z] \quad y[k-1] \iff \frac{1}{z}Y[z] + 2 \quad y[k-2] \iff \frac{1}{z^2}Y[z] + \frac{2}{z} + 3$$

$$f[k] \iff F[z] \quad f[k-1] \iff \frac{1}{z}F[z]$$

$$F[z] = \frac{z}{z-3}$$

The  $z$ -transform of the system equation is

$$Y[z] - 3 \left[ \frac{1}{z}Y[z] + 2 \right] + 2 \left[ \frac{1}{z^2}Y[z] + \frac{2}{z} + 3 \right] = \frac{1}{z-3}$$

$$\left( 1 - \frac{3}{z} + \frac{2}{z^2} \right) Y[z] = -\frac{4}{z} + \frac{1}{z-3} = \frac{-3z+12}{z(z-3)}$$

$$\frac{Y[z]}{z} = \frac{-3z+12}{(z^2-3z+2)(z-3)} = \frac{-3z+12}{(z-1)(z-2)(z-3)} = \frac{9/2}{z-1} - \frac{6}{z-2} + \frac{3/2}{z-3}$$

$$Y[z] = \frac{9}{2} \frac{z}{z-1} - 6 \frac{z}{z-2} + \frac{3}{2} \frac{z}{z-3}$$

$$y[k] = \left[ \frac{9}{2} - 6(2)^k + \frac{3}{2}(3)^k \right] u[k]$$

5.3-7 The system equation in delay form is

$$y[k] - 2y[k-1] + 2y[k-2] = f[k-2]$$

$$y[k] \iff Y[z] \quad y[k-1] \iff \frac{1}{z}Y[z] + 1 \quad y[k-2] \iff \frac{1}{z^2}Y[z] + \frac{1}{z}$$

$$f[k-2] \iff \frac{1}{z^2}F[z] \quad \text{and} \quad F[z] = \frac{z}{z-1}$$

The  $z$ -transform of the difference equation is

$$Y[z] - 2 \left[ \frac{1}{z}Y[z] + 1 \right] + 2 \left[ \frac{1}{z^2}Y[z] + \frac{1}{z} \right] = \frac{1}{z(z-1)}$$

$$\frac{(z^2-2z+2)}{z^2}Y[z] = \frac{2z^2-4z+3}{z(z-1)}$$

$$\frac{Y[z]}{z} = \frac{2z^2 - 4z + 3}{(z-1)(z^2 - 2z + 2)} = \frac{1}{z-1} + \frac{z-1}{z^2 - 2z + 2}$$

$$Y[z] = \frac{z}{z-1} + \frac{z(z-1)}{z^2 - 2z + 2}$$

For the second fraction on the right-hand side, we use pair 12c with  $A = 1$ ,  $B = -1$ ,  $a = -1$ ,  $|\gamma|^2 = 2$ . This yields  $r = 1$ ,  $\beta = \frac{\pi}{4}$ , and  $\theta = 0$ . Therefore

$$y[k] = [1 + (\sqrt{2})^k \cos(\frac{\pi}{4}k)] u[k]$$

5.3-8 The equation in advance form is

$$y[k+2] + 2y[k+1] + 2y[k] = f[k+1] + 2f[k]$$

$$y[k] \iff Y[z] \quad y[k+1] \iff zY[z] \quad y[k+2] \iff z^2Y[z] - z$$

$$f[k] \iff F[z] \quad f[k+1] \iff zF[z] - z \quad \text{and} \quad F[z] = \frac{z}{z-e}$$

The  $z$ -transform of the difference equation is

$$z^2Y[z] - z + 2zY[z] + 2Y[z] = \frac{z^2}{z-e} - z + \frac{2z}{z-e} = \frac{z(e+2)}{z-e}$$

$$(z^2 + 2z + 2)Y[z] = z + \frac{z(e+2)}{z-e} = \frac{z(z+2)}{z-e}$$

Therefore

$$\frac{Y[z]}{z} = \frac{z+2}{(z-e)(z^2+2z+2)} = \frac{0.318}{z-e} + \frac{-0.318z - 0.502}{z^2+2z+2}$$

$$Y[z] = 0.318 \frac{z}{z-e} - \frac{z(0.318z + 0.502)}{z^2+2z+2}$$

For the second fraction on the right-hand side, we use pair 12c with  $A = 0.318$ ,  $B = 0.502$ ,  $a = 1$ ,  $|\gamma|^2 = 2$  and

$$r = 0.367 \quad \beta = \cos^{-1}(\frac{-1}{\sqrt{2}}) = \frac{3\pi}{4} \quad \theta = \tan^{-1}(\frac{-0.318}{0.318}) = -0.525$$

$$y[k] = [0.318(e)^k - 0.367(\sqrt{2})^k \cos(\frac{3\pi}{4}k - 0.525)] u[k]$$

5.3-9

$$f[k] = ce^k u[k] \quad F[z] = \frac{cz}{z-e}$$

$$Y[z] = F[z]H[z] = \frac{ez^2}{(z-e)(z+0.2)(z-0.8)}$$

Therefore

$$\frac{Y[z]}{z} = \frac{ez}{(z-e)(z+0.2)(z-0.8)} = \frac{1.32}{z-e} - \frac{0.186}{z+0.2} - \frac{1.13}{z-0.8}$$

$$Y[z] = 1.32 \frac{z}{z-e} - 0.186 \frac{z}{z+0.2} - 1.13 \frac{z}{z-0.8}$$

$$y[k] = [1.32(e)^k - 0.186(-0.2)^k - 1.13(0.8)^k] u[k]$$

5.3-10

$$Y[z] = F[z]H[z] = \frac{z(2z+3)}{(z-1)(z-2)(z-3)}$$

Therefore

$$\frac{Y[z]}{z} = \frac{2z+3}{(z-1)(z-2)(z-3)} = \frac{5/2}{z-1} - \frac{7}{z-2} + \frac{9/2}{z-3}$$

$$Y[z] = \frac{5}{2} \frac{z}{z-1} - 7 \frac{z}{z-2} + \frac{9}{2} \frac{z}{z-3}$$

$$y[k] = [\frac{5}{2} - 7(2)^k + \frac{9}{2}(3)^k] u[k]$$

5.3-11 (a)  $f[k] = 4^{-k}u[k] = (\frac{1}{4})^k u[k]$  so that  $F[z] = \frac{z}{z-\frac{1}{4}}$ , and

$$Y[z] = F[z]H[z] = \frac{6z(5z-1)}{(z-\frac{1}{4})(6z^2-5z+1)} = \frac{z(5z-1)}{(z-\frac{1}{4})(z-\frac{1}{3})(z-\frac{1}{2})}$$

Therefore

$$\begin{aligned} \frac{Y[z]}{z} &= \frac{5z-1}{(z-\frac{1}{4})(z-\frac{1}{3})(z-\frac{1}{2})} = \frac{12}{z-\frac{1}{4}} - \frac{48}{z-\frac{1}{3}} + \frac{36}{z-\frac{1}{2}} \\ Y[z] &= 12\frac{z}{z-\frac{1}{4}} - 48\frac{z}{z-\frac{1}{3}} + 36\frac{z}{z-\frac{1}{2}} \\ y[k] &= [12(\frac{1}{4})^k - 48(\frac{1}{3})^k + 36(\frac{1}{2})^k] u[k] \\ &= 12[4^{-k} - 4(3)^{-k} + 3(2)^{-k}] u[k] \end{aligned}$$

(b) Here the input is  $4^{-(k-2)}u[k-2]$  which is identical to the input in part (a) delayed by 2 units. Therefore the response will be the output in part (a) delayed by 2 units (time-invariance property). Therefore

$$y[k] = 12[4^{-(k-2)} - 4(3)^{-(k-2)} + 3(2)^{-(k-2)}] u[k-2]$$

(c) Here the input can be expressed as

$$f[k] = 4^{-(k-2)}u[k] = 16(4)^{-k}u[k]$$

This input is 16 times the input in part (a). Therefore the response will be 16 times the output in part (a) (linearity property). Therefore

$$y[k] = 192[4^{-k} - 4(3)^{-k} + 3(2)^{-k}] u[k]$$

(d) Here the input can be expressed as

$$f[k] = 4^{-k}u[k-2] = \frac{1}{16}(4)^{-(k-2)}u[k-2]$$

This input is  $\frac{1}{16}$  times the input in part (b). Therefore the response will be  $\frac{1}{16}$  times the output in part (b). Therefore

$$y[k] = \frac{3}{4}[4^{-(k-2)} - 4(3)^{-(k-2)} + 3(2)^{-(k-2)}] u[k-2]$$

5.3-12

$$Y[z] = F[z]H[z] = \frac{z(2z-1)}{(z-1)(z^2-1.6z+0.8)}$$

$$\begin{aligned} \frac{Y[z]}{z} &= \frac{2z-1}{(z-1)(z^2-1.6z+0.8)} = \frac{5}{z-1} - \frac{5(z-1)}{z^2-1.6z+0.8} \\ Y[z] &= 5\frac{z}{z-1} - 5\frac{z(z-1)}{z^2-1.6z+0.8} \end{aligned}$$

For the second fraction on the right-hand side, we use pair 12c with  $A = 1$ ,  $B = -1$ ,  $a = -0.8$ ,  $\gamma = \frac{2}{\sqrt{5}}$ ,  $|\gamma|^2 = 0.8$ . Therefore

$$r = 1.118 \quad \beta = \cos^{-1}\left(\frac{0.4\sqrt{5}}{2}\right) = 0.464 \quad \theta = \tan^{-1}\left(\frac{0.2}{0.4}\right) = 0.464$$

$$\begin{aligned} y[k] &= \left[ 5 - 5(1.118) \left(\frac{2}{\sqrt{5}}\right)^k \cos(0.464k + 0.464) \right] u[k] \\ &= \left[ 5 - 5.59 \left(\frac{2}{\sqrt{5}}\right)^k \cos(0.464k + 0.464) \right] u[k] \end{aligned}$$

5.3-13 (a)  $\frac{z}{z+2}$  (b)  $\frac{4z^2-3z}{2z^2-3z+1}$  (c)  $\frac{z}{4z^2+4z+1}$

5.3-14 (a)  $\frac{z}{z^2-3z+2}$  (b)  $\frac{1}{z^2-2z+2}$

5.3-15 (a)

$$H[z] = \frac{z^2 + 3z + 3}{z^2 + 3z + 2} = \frac{z^2 + 3z + 3}{(z+1)(z+2)}$$

Therefore

$$\frac{H[z]}{z} = \frac{z^2 + 3z + 3}{z(z+1)(z+2)} = \frac{3/2}{z} - \frac{1}{z+1} + \frac{1/2}{z+2}$$

$$H[z] = \frac{3}{2} - \frac{z}{z+1} + \frac{1}{2} \frac{z}{z+2}$$

$$h[k] = \left[ \frac{3}{2} \delta[k] - (-1)^k + \frac{1}{2} (-2)^k \right] u[k]$$

(b)

$$H[z] = \frac{2z^2 - z}{z^2 + 2z + 1} = \frac{z(2z - 1)}{(z+1)^2}$$

Therefore

$$\frac{H[z]}{z} = \frac{2z - 1}{(z+1)^2} = \frac{2}{z+1} - \frac{3}{(z+1)^2}$$

$$H[z] = 2 \left( \frac{z}{z+1} \right) - 3 \frac{z}{(z+1)^2}$$

$$h[k] = [2(-1)^k + 3k(-1)^k] u[k] = (2 + 3k)(-1)^k u[k]$$

(c)

$$H[z] = \frac{z^2 + 2z}{z^2 - z + 0.5} = \frac{z(z+2)}{z^2 - z + 0.5}$$

Therefore

$$\frac{H[z]}{z} = \frac{z+2}{z^2 - z + 0.5}$$

We use pair 12c with  $A = 1$ ,  $B = 2$ ,  $a = -0.5$ ,  $|\gamma|^2 = 0.5$ ,  $|\gamma| = \frac{1}{\sqrt{2}}$ , and

$$r = 5.099 \quad \beta = \cos^{-1}(0.5\sqrt{5}) = \frac{\pi}{4} \quad \theta = \tan^{-1}\left(\frac{-2.5}{0.5}\right) = -1.373$$

$$h[k] = 5.099 \left(\frac{1}{\sqrt{2}}\right)^k \cos\left(\frac{\pi}{4} - 1.373\right) u[k]$$

5.3-16 (a)

$$\frac{H[z]}{z} = \frac{1}{(z+0.2)(z-0.8)} = \frac{-1}{z+0.2} + \frac{1}{z-0.8}$$

$$H[z] = -\frac{z}{z+0.2} + \frac{z}{z-0.8}$$

$$h[k] = [ -(-0.2)^k + (0.8)^k ] u[k]$$

(b)

$$\frac{H[z]}{z} = \frac{2z + 3}{z(z-2)(z-3)} = \frac{1/2}{z} - \frac{7/2}{z-2} + \frac{3}{z-3}$$

$$H[z] = \frac{1}{2} - \frac{7}{2} \frac{z}{z-2} + 3 \frac{z}{z-3}$$

$$h[k] = \left[ \frac{1}{2} \delta[k] - \frac{7}{2} (2)^k + 3(3)^k \right] u[k]$$

(c)

$$\frac{H[z]}{z} = \frac{2z - 1}{z(z^2 - 1.6z + 0.8)} = \frac{-1.25}{z} + \frac{1.25z}{z^2 - 1.6z + 0.8}$$

For the second fraction on the right-hand side,  $A = 1.25$ ,  $B = 0$ ,  $a = -0.8$ ,  $|\gamma|^2 = 0.8$ ,  $|\gamma| = \frac{2}{\sqrt{5}}$ , and

$$r = 2.795 \quad \beta = \cos^{-1}\left(\frac{2.4\sqrt{5}}{5}\right) = 0.464 \quad \theta = \tan^{-1}(-2) = -1.107$$

$$h[k] = -1.25 \delta[k] + 2.795 \left(\frac{2}{\sqrt{5}}\right)^k \cos(0.464k - 1.107) u[k]$$

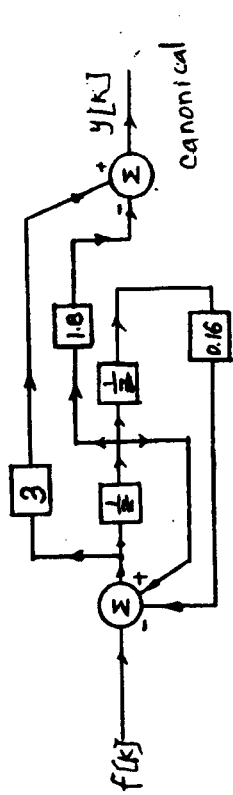

canonical

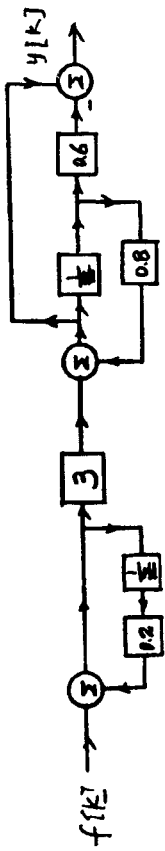

cascade

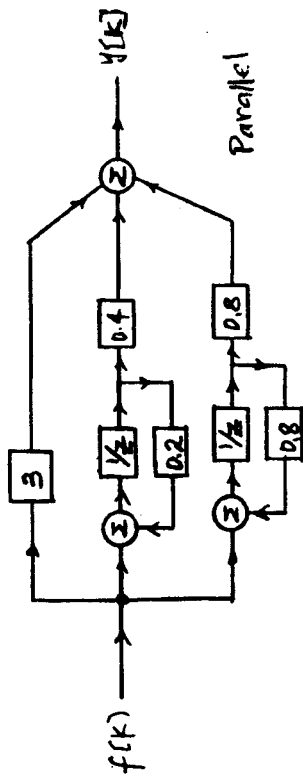

Parallel

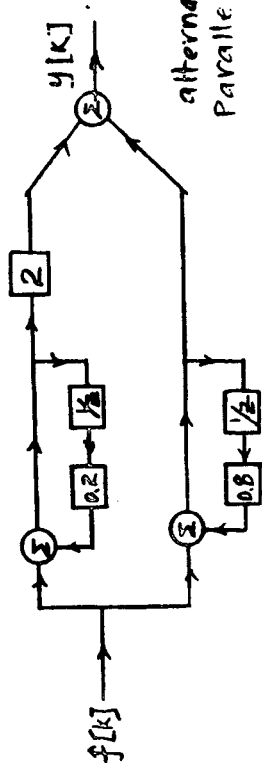

alternate Parallel

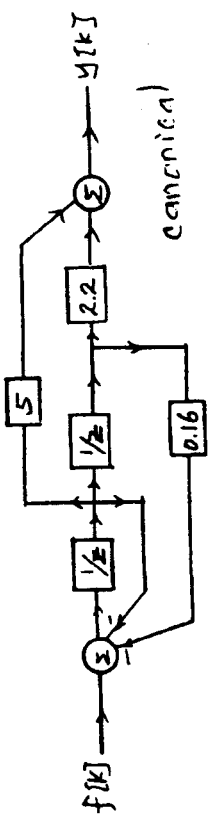

canonical

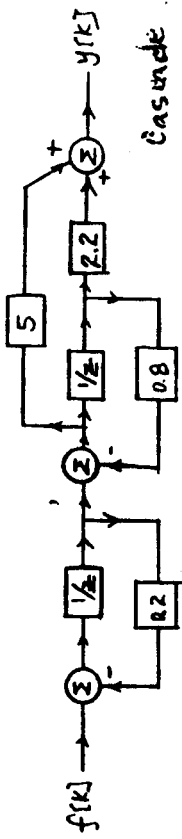

cascade

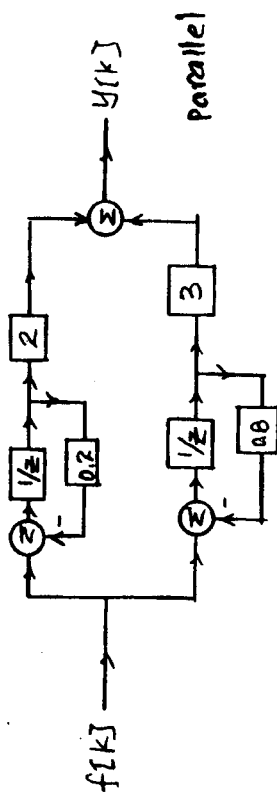

parallel

Figure S5.4-1b

Figure S5.4-1a

5.4-1 (a)

$$H[s] = \frac{3s^2 - 1.8s}{s^2 - s + 0.16} = \frac{3s(s - 0.6)}{(s - 0.2)(s - 0.8)} = \left( \frac{3s}{s - 0.2} \right) \left( \frac{s - 0.6}{s - 0.8} \right)$$

Parallel form: To realize parallel form, we could expand  $H[s]$  or  $H[s]/s$  into partial fractions. In our case:

$$H[s] = 3 + \frac{1.2s - 0.48}{(s - 0.2)(s - 0.8)}$$

$$H[s] = 3 + \frac{0.4}{(s - 0.2)} + \frac{0.8}{(s - 0.8)}$$

Alternatively we could expand  $H[s]/s$  into partial fractions as:

$$\frac{H[s]}{s} = \frac{3(s - 0.6)}{(s - 0.2)(s - 0.8)} = \frac{2}{s - 0.2} + \frac{1}{s - 0.8}$$

and

$$H[s] = 2 \frac{s}{s - 0.2} + \frac{s}{s - 0.8}$$

The realizations are shown in Fig. S5.4-1a.

(b)

$$\begin{aligned} H[s] &= \frac{5s + 2.2}{(s + 0.2)(s + 0.8)} = \frac{5s + 2.2}{s^2 + s + 0.16} \\ &= \left( \frac{1}{s + 0.2} \right) \left( \frac{5s + 2.2}{s + 0.8} \right) = \frac{2}{s + 0.2} + \frac{3}{s + 0.8} \end{aligned}$$

All the realizations are shown in Fig. S5.4-1b.

(c)

$$H[s] = \frac{3.8s - 1.1}{s^2 - 0.8s + 0.37s - 0.05}$$

For a cascade form, we express  $H[s]$  as:

$$H[s] = \left( \frac{1}{s - 0.2} \right) \left( \frac{3.8s - 1.1}{s^2 - 0.6s + 0.25} \right)$$

For a parallel form, we express  $H[s]$  as:

$$H[s] = \frac{-2}{s - 0.2} + \frac{2s + 3}{s^2 - 0.6s + 0.25}$$

All the realizations are shown in Fig. S5.4-1c.

5.4-2. Note: the complex conjugate poles must be realized together as a second order factor

(a) Cascade form:

$$H[s] = \left( \frac{s}{s - 0.2} \right) \left( \frac{1.6s - 1.8}{s^2 + s + 0.5} \right)$$

Parallel form:

$$H[s] = \frac{-2s}{s - 0.2} + \frac{2s^2 + 4s}{s^2 + s + 0.5}$$

(b) Cascade form:

$$H[s] = \left( \frac{s}{s + 0.5} \right) \left( \frac{2s^2 + 1.3s + 0.96}{s^2 - 0.8s + 0.16} \right)$$

Parallel form:

$$H[s] = \frac{s}{s + 0.5} + \frac{s}{s - 0.4} + \frac{2s}{(s - 0.4)^2}$$

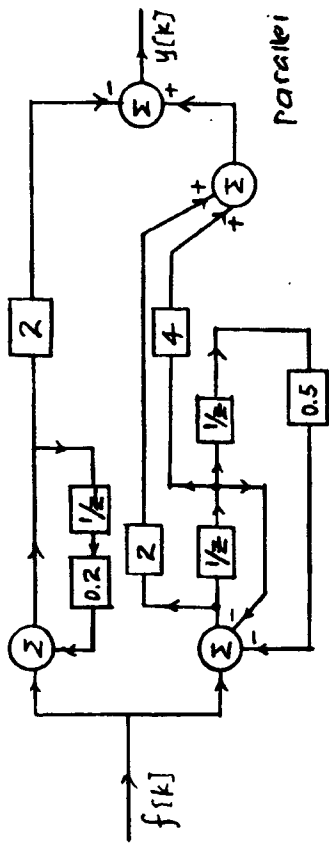
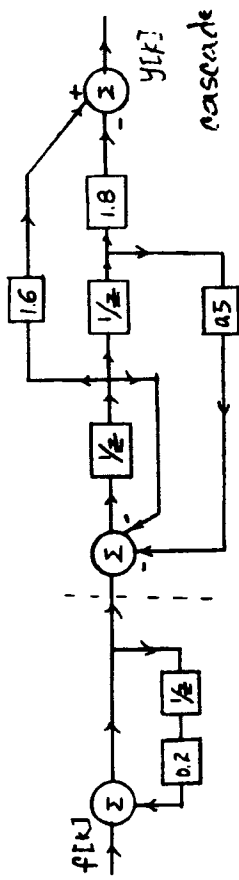

Figure S5.4-2 a

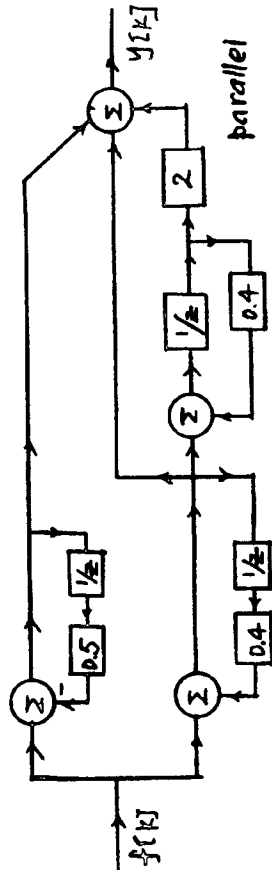
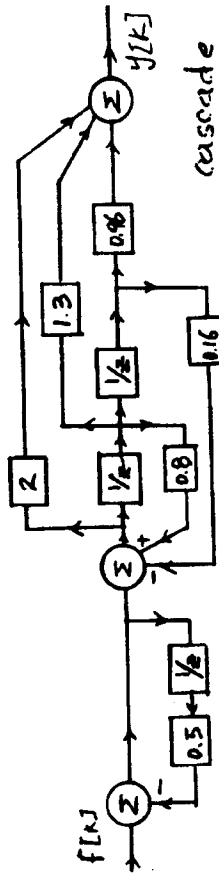

Figure S5.4-2b

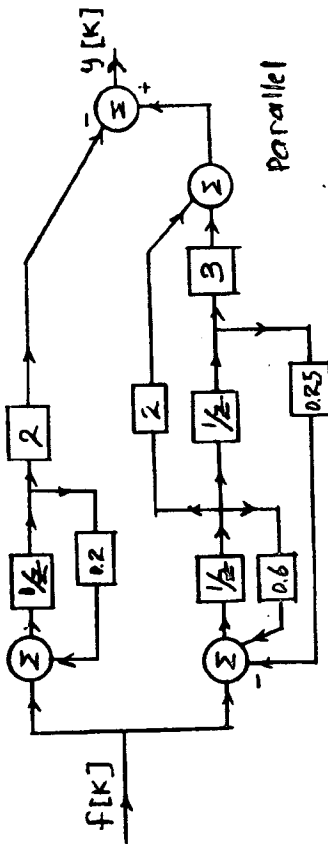
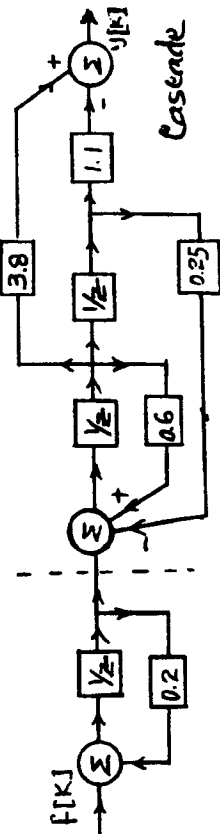
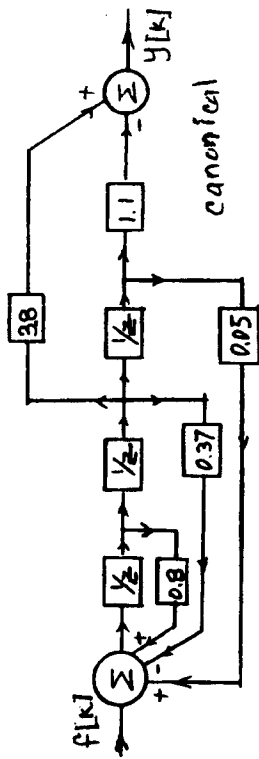

Figure S5.4-1c



5.4-3.

$$H[z] = 2 + \frac{1}{z} + \frac{0.8}{z^2} + \frac{2}{z^3} + \frac{8}{z^4} = \frac{2z^4 + z^3 + 0.8z^2 + 2z + 8}{z^4}$$

The realization of this transfer function is shown in Fig. S5.4-3. It can be explained in two ways. The realization has 5 paths in parallel, and each path represents one term in the transfer function. The first path (which bypasses all the delays) has transfer function 2. The second path (going through only one delay) has transfer function  $1/z$ , and so on. Alternately we observe that this transfer function has  $a_0 = a_1 = a_2 = a_3 = 0$ , and  $b_0 = 8, b_1 = 2, b_2 = 0.8, b_3 = 1, b_4 = 2$ . Therefore all the feedback coefficients are zero, and there are no feedback paths. There are 4 feedforward paths with gains 8, 2, 0.8, and 2 as shown in the realization.

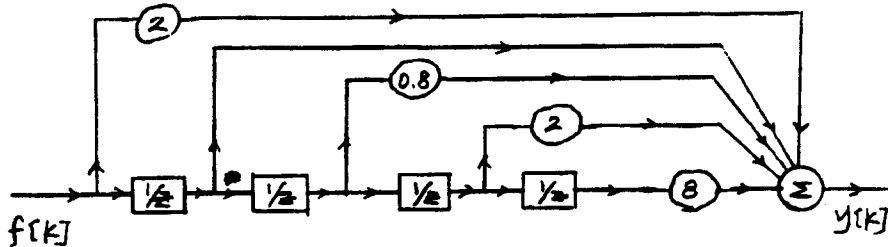

Figure S5.4-3

5.4-4

$$H[z] = \frac{1}{z} + \frac{2}{z^2} + \frac{3}{z^3} + \frac{4}{z^4} + \frac{5}{z^5} + \frac{6}{z^6}$$

This transfer function is similar to that in Prob. 5.4-3. Its realization is shown in Fig. S5.4-4.

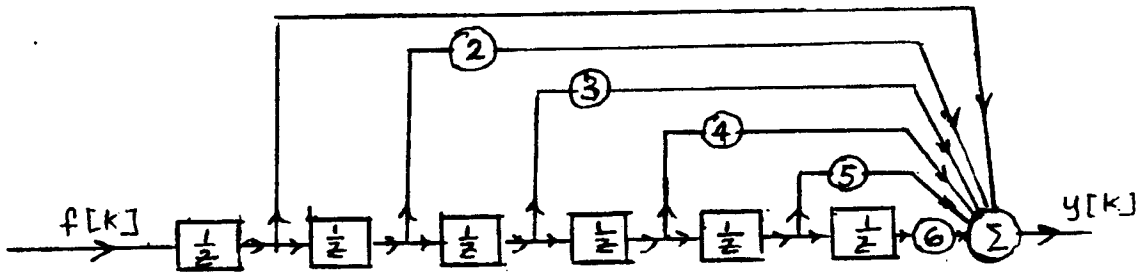

Figure S5.4-4

5.5-1 (a)

$$H[z] = \frac{1}{z-0.4} \quad \text{and} \quad H[e^{j\Omega}] = \frac{1}{e^{j\Omega} - 0.4} = \frac{1}{\cos \Omega - 0.4 + j \sin \Omega}$$

$$|H[e^{j\Omega}]|^2 = HH^* = \frac{1}{(e^{j\Omega} - 0.4)(e^{-j\Omega} - 0.4)} = \frac{1}{1.16 - 0.8 \cos \Omega}$$

$$|H[e^{j\Omega}]| = \frac{1}{\sqrt{1.16 - 0.8 \cos \Omega}}$$

and

$$\angle H[e^{j\Omega}] = -\tan^{-1} \frac{\sin \Omega}{\cos \Omega - 0.4}$$

(b)

$$H[z] = \frac{z}{z-0.4} = \frac{1}{1-0.4z^{-1}}$$

$$\text{and} \quad H[e^{j\Omega}] = \frac{1}{1-0.4e^{-j\Omega}} = \frac{1}{1-0.4 \cos \Omega - j \sin \Omega}$$

Therefore

$$|H[e^{j\Omega}]| = \sqrt{HH^*} = \sqrt{\frac{1}{1-0.4e^{-j\Omega}} \frac{1}{1-0.4e^{j\Omega}}} = \frac{1}{\sqrt{1.16 - 0.8 \cos \Omega}}$$

and

$$\angle H [e^{j\Omega}] = -\tan^{-1} \left( \frac{0.4 \sin \Omega}{1 - 0.4 \cos \Omega} \right)$$

(c)

$$H(z) = \frac{3z^2 - 1.8z}{z^2 - z + 0.16}$$

$$\text{and } H [e^{j\Omega}] = \frac{3e^{2j\Omega} - 1.8e^{j\Omega}}{e^{2j\Omega} - e^{j\Omega} + 0.16} = \frac{(3 \cos 2\Omega - 1.8 \cos \Omega) + j(3 \sin 2\Omega - 1.8 \sin \Omega)}{(\cos 2\Omega - \cos \Omega + 0.16) + j(\sin 2\Omega - \sin \Omega)}$$

$$\begin{aligned} |H [e^{j\Omega}]|^2 &= \left[ \frac{3e^{2j\Omega} - 1.8e^{j\Omega}}{e^{2j\Omega} - e^{j\Omega} + 0.16} \right] \left[ \frac{3e^{-2j\Omega} - 1.8e^{-j\Omega}}{e^{-2j\Omega} - e^{-j\Omega} + 0.16} \right] \\ &= \frac{12.24 - 10.8 \cos \Omega}{2.0256 - 2.32 \cos \Omega + 0.32 \cos 2\Omega} \end{aligned}$$

$$\text{Therefore } |H [e^{j\Omega}]| = \left[ \frac{12.24 - 10.8 \cos \Omega}{2.0256 - 2.32 \cos \Omega + 0.32 \cos 2\Omega} \right]^{1/2}$$

and

$$\angle H [e^{j\Omega}] = \tan^{-1} \left( \frac{3 \sin 2\Omega - 1.8 \sin \Omega}{3 \cos 2\Omega - 1.8 \cos \Omega} \right) - \tan^{-1} \left( \frac{\sin 2\Omega - \sin \Omega}{\cos 2\Omega - \cos \Omega + 0.16} \right)$$

5.5-2 (a)

$$H(z) = 1 + \frac{0.5}{z} + \frac{2}{z^2} + \frac{2}{z^3} + \frac{0.5}{z^4} + \frac{1}{z^5}$$

$$\begin{aligned} H [e^{j\Omega}] &= 1 + 0.5e^{-j\Omega} + 2e^{-2j\Omega} + 2e^{-3j\Omega} + 0.5e^{-4j\Omega} + e^{-5j\Omega} \\ &= e^{-j2.5\Omega} [e^{j2.5\Omega} + 0.5e^{j1.5\Omega} + 2e^{j0.5\Omega} + 0.5e^{-j1.5\Omega} + e^{-j2.5\Omega}] \\ &= 2e^{-j2.5\Omega} \left[ 2 \cos \frac{\Omega}{2} + \frac{1}{2} \cos \frac{3\Omega}{2} + \cos \frac{5\Omega}{2} \right] \end{aligned}$$

$$\text{Therefore } |H [e^{j\Omega}]| = |4 \cos \frac{\Omega}{2} + \cos \frac{3\Omega}{2} + 2 \cos \frac{5\Omega}{2}|$$

$$\text{and } \angle H [e^{j\Omega}] = -2.5\Omega$$

(b) Using the same procedure as in Prob. 5.45a, we obtain:

$$|H [e^{j\Omega}]| = |4 \sin \frac{\Omega}{2} + \sin \frac{3\Omega}{2} + 2 \sin \frac{5\Omega}{2}|$$

$$\text{and } \angle H [e^{j\Omega}] = -2.5\Omega - \pi/2.$$

5.5-3

$$H(z) = \frac{z + 0.8}{z - 0.5}$$

(a)

$$\begin{aligned} H [e^{j\Omega}] &= \frac{e^{j\Omega} + 0.8}{e^{j\Omega} - 0.5} = \frac{(\cos \Omega + 0.8) + j \sin \Omega}{(\cos \Omega - 0.5) + j \sin \Omega} \\ |H [e^{j\Omega}]|^2 &= H [e^{j\Omega}] H [e^{-j\Omega}] = \frac{(e^{j\Omega} + 0.8)(e^{-j\Omega} + 0.8)}{(e^{j\Omega} - 0.5)(e^{-j\Omega} - 0.5)} = \frac{1.64 + 1.6 \cos \Omega}{1.25 - \cos \Omega} \\ \angle H [e^{j\Omega}] &= \tan^{-1} \left( \frac{\sin \Omega}{\cos \Omega + 0.8} \right) - \tan^{-1} \left( \frac{\sin \Omega}{\cos \Omega - 0.5} \right) \end{aligned}$$

(b)  $\Omega = 0.5$

$$|H[e^{j0.5}]|^2 = \frac{1.64 + 1.6 \cos(0.5)}{1.25 - \cos(0.5)} = 8.174$$

$$|H[e^{j0.5}]| = 2.86$$

$$\angle H[e^{j0.5}] = 0.2784 - 0.9037 = -0.6253 \text{ rad}$$

Therefore

$$y[k] = 2.86 \cos(0.5k - \frac{\pi}{4} - 0.6253) = 2.86 \cos(0.5k - 1.6725)$$

5.5-4 (a)

$$H[z] = K \frac{z+1}{z-a}$$

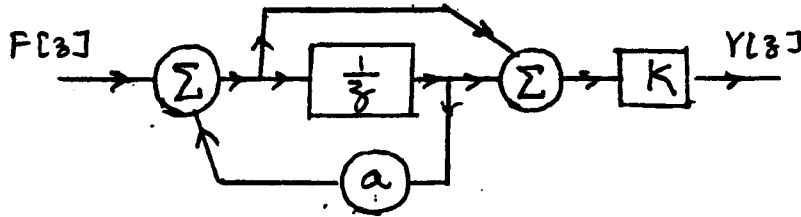

Figure S5.5-4

$$H[1] = \frac{2K}{1-a} = 1 \Rightarrow K = \frac{1-a}{2}$$

$$\text{and } H[z] = \left(\frac{1-a}{2}\right) \frac{z+1}{z-a}$$

$$H[e^{j\Omega}] = \frac{1-a}{2} \left(\frac{e^{j\Omega} + 1}{e^{j\Omega} - a}\right) = \frac{1-a}{2} \left(\frac{\cos \Omega + 1 + j \sin \Omega}{\cos \Omega - a + j \sin \Omega}\right)$$

$$|H[e^{j\Omega}]| = \left(\frac{1-a}{2}\right) \sqrt{\frac{2(1+\cos \Omega)}{1+a^2-2a \cos \Omega}}$$

$$\angle H[e^{j\Omega}] = \tan^{-1} \left(\frac{\sin \Omega}{\cos \Omega + 1}\right) - \tan^{-1} \left(\frac{\sin \Omega}{\cos \Omega - a}\right)$$

For  $a = 0.2$

$$|H[e^{j\Omega}]| = 0.4 \sqrt{\frac{2(1+\cos \Omega)}{1.04 - 0.4 \cos \Omega}}$$

For 3 dB bandwidth  $|H|^2 = 1/2$ . Hence

$$\frac{1}{2} = (0.4)^2 \left[ \frac{2(1+\cos \Omega)}{1.04 - 0.4 \cos \Omega} \right] \Rightarrow \Omega = 1.176$$

$$\text{Hence } B = \frac{\omega}{2\pi} = \frac{1.176}{2\pi T} = \frac{0.187}{T} \text{ Hz}$$

5.5-5 Figure S5.5-5 shows a rough sketch of the amplitude and phase response of this filter. For the case (a), the poles are in the vicinity of  $\Omega = \frac{\pi}{4}$ . therefore, the gain  $|H[e^{j\Omega}]|$  is high in the vicinity of  $\Omega = \pi/4$ . In the case (b), the poles are in the vicinity of  $\Omega = \pi$ . therefore, the gain  $|H[e^{j\Omega}]|$  is high in the vicinity of  $\Omega = \pi$ .

5.5-6

$$T \leq \frac{1}{2B_b} = \frac{1}{40000} = 25 \mu\text{s}$$

Select  $T = 25 \mu\text{s}$

Frequency 5000 Hz gives

$$\Omega = \omega T = 2\pi \times 5000 \times 25 \times 10^{-6} = \pi/4$$

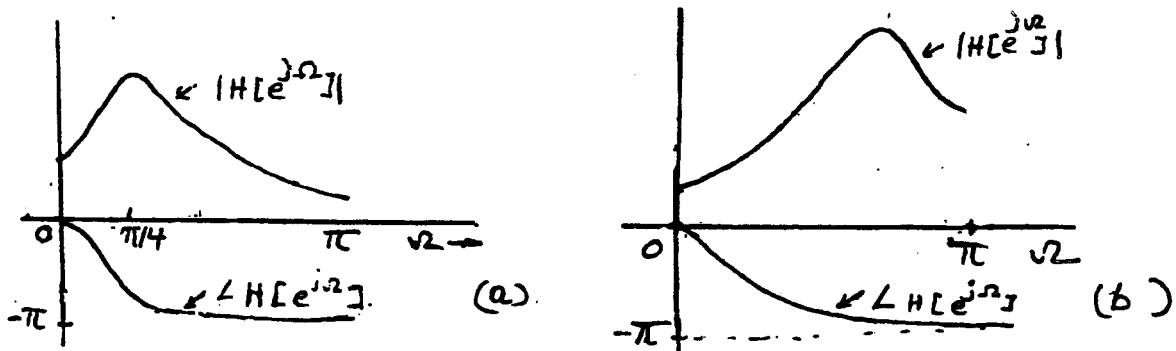

Fig. S5.5-5

Therefore frequency 5000 Hz corresponds to angles  $\pm\pi/4$ . We must place zeros at  $e^{\pm j\pi/4}$ . For fast recovery on either side of 5000 Hz, we read poles at  $ae^{\pm j\pi/4}$  where  $a < 1$  and  $a \approx 1$ . The transfer function is

$$H[z] = K \frac{(z - e^{j\pi/4})(z - e^{-j\pi/4})}{(z - ae^{j\pi/4})(z - ae^{-j\pi/4})} = \frac{K(z^2 - \sqrt{2}z + 1)}{z^2 - \sqrt{2}az + a^2}$$

The constant  $K$  is chosen to have unity gain at  $\omega = 0$  ( $\Omega = 0$ ) or  $z = e^{j\Omega} = 1$ . ( $H[1] = 1$ )

$$H[1] = \frac{K(2 - \sqrt{2})}{1 + a^2 - \sqrt{2}a} = 1$$

$$K = \frac{1 + a^2 - \sqrt{2}a}{2 - \sqrt{2}} = 1.707(1 + a^2 - \sqrt{2}a)$$

$$|H[e^{j\Omega}]|^2 = K^2 \frac{(e^{j2\Omega} - \sqrt{2}e^{j\Omega} + 1)(e^{-j2\Omega} - \sqrt{2}e^{-j\Omega} + 1)}{(e^{j2\Omega} - \sqrt{2}ae^{j\Omega} + a^2)(e^{-j2\Omega} - \sqrt{2}ae^{-j\Omega} + a^2)}$$

$$= K^2 \frac{4 - 4\sqrt{2}\cos\Omega + 2\cos 2\Omega}{(1 + a^2)^2 - 2\sqrt{2}a(1 + a^2)\cos\Omega + 2a^2\cos 2\Omega}$$

5.5-7

$$|H[e^{j\Omega}]|^2 = H[e^{j\Omega}]H[e^{-j\Omega}] = \frac{(e^{j\Omega} - \frac{1}{r})(e^{-j\Omega} - \frac{1}{r})}{(e^{j\Omega} - r)(e^{-j\Omega} - r)} = \frac{1 + \frac{1}{r^2} - \frac{2}{r}\cos\Omega}{1 + r^2 - 2r\cos\Omega} = \frac{1}{r^2}$$

This shows that the amplitude response is constant ( $|H[e^{j\Omega}]| = \frac{1}{r}$ ) for all values of  $\Omega$ . The filter is an allpass filter. This result can be generalized exactly the same way for complex poles and zeros.

5.5-8

$$Y[z] = F[z]H[z]$$

For an input  $f[k] = e^{j\Omega k}u[k]$ , pair 7 in Table 5.1 yields

$$F[z] = \frac{z}{z - e^{j\Omega}}$$

and

$$Y[z] = \frac{zH[z]}{z - e^{j\Omega}}$$

Therefore if

$$H[z] = \frac{P[z]}{Q[z]} = \frac{P[z]}{(z - \gamma_1)(z - \gamma_2)\cdots(z - \gamma_n)}$$

then

$$Y[z] = \frac{zP[z]}{(z - \gamma_1)(z - \gamma_2)\cdots(z - \gamma_n)(z - e^{j\Omega})}$$

and

$$\begin{aligned} \frac{Y[z]}{z} &= \frac{P[z]}{(z - \gamma_1)(z - \gamma_2) \cdots (z - \gamma_n)(z - e^{j\Omega})} \\ &= \frac{c_1}{z - \gamma_1} + \frac{c_2}{z - \gamma_2} + \cdots + \frac{c_n}{z - \gamma_n} + \frac{A}{z - e^{j\Omega}} \end{aligned}$$

The coefficient  $A$  on the right-hand side is given by

$$\begin{aligned} A &= \left. \frac{P[z]}{(z - \gamma_1)(z - \gamma_2) \cdots (z - \gamma_n)(z - e^{j\Omega})} \right|_{z=e^{j\Omega}} \\ &= H[z] \Big|_{z=e^{j\Omega}} \\ &= H[e^{j\Omega}] \end{aligned}$$

Therefore

$$Y[z] = \sum_{i=1}^n c_i \frac{z}{z - \gamma_i} + H[e^{j\Omega}] \frac{z}{z - e^{j\Omega}}$$

and

$$y[k] = \left[ \sum_{i=1}^n c_i \gamma_i^k + H[e^{j\Omega}] e^{j\Omega k} \right] u[k]$$

The sum on the right-hand side consists of  $n$  characteristic modes the system. For an asymptotically stable system  $|\gamma_i| < 1$  ( $i = 1, 2, \dots, n$ ) and the sum on the right-hand side vanishes as  $k \rightarrow \infty$ . This sum is therefore the transient component of the response. The last terms  $H[e^{j\Omega}] e^{j\Omega k}$ , which does not vanish as  $k \rightarrow \infty$ , is the steady-state component of the response  $y_{ss}[k]$ :

$$y_{ss}[k] = H[e^{j\Omega}] e^{j\Omega k}$$

5.7-1 (a)

$$f[k] = \underbrace{(0.8)^k u[k]}_{f_1[k]} + \underbrace{2^k u[-(k+1)]}_{f_2[k]}$$

$$f_1[k] \longleftrightarrow \frac{z}{z - 0.8} \quad |z| > 0.8$$

$$f_2[k] \longleftrightarrow \frac{-z}{z - 2} \quad |z| < 2$$

Hence

$$\begin{aligned} F[z] &= \frac{z}{z - 0.8} - \frac{z}{z - 2} \quad 0.8 < |z| < 2 \\ &= \frac{-1.2z}{z^2 - 2.8z + 1.6} \quad 0.8 < |z| < 2 \end{aligned}$$

(b)

$$F_1[z] = \frac{z}{z - 2} \quad |z| > 2$$

$$F_2[z] = \frac{z}{z - 3} \quad |z| < 3$$

Hence

$$\begin{aligned} F[z] &= \frac{z}{z - 2} + \frac{z}{z - 3} \quad 2 < |z| < 3 \\ &= \frac{z(2z - 5)}{z^2 - 5z + 6} \quad 2 < |z| < 3 \end{aligned}$$

(c)

$$F_1[z] = \frac{z}{z-0.8} \quad |z| > 0.8$$

$$F_2[z] = \frac{-z}{z-0.9} \quad |z| < 0.9$$

$$\begin{aligned} \text{Hence } F[z] &= \frac{z}{z-0.8} - \frac{z}{z-0.9} \\ &= \frac{-z}{10(z^2 - 1.7z + 0.72)} \quad 0.8 < |z| < 0.9 \end{aligned}$$

(d)

$$\begin{aligned} [(0.8)^k + 3(0.4)^k] u[-(k+1)] &\iff \left( \frac{-z}{z-0.8} - \frac{3z}{z-0.4} \right) \quad |z| < 0.4 \\ &= \frac{-4z(z-0.7)}{(z-0.4)(z-0.8)} \quad |z| < 0.4 \end{aligned}$$

(e)

$$\begin{aligned} [(0.8)^k + 3(0.4)^k] u[k] &\iff \frac{z}{z-0.8} + \frac{3z}{z-0.4} \quad |z| > 0.8 \\ &= \frac{4z(z-0.7)}{(z-0.4)(z-0.8)} \quad |z| > 0.8 \end{aligned}$$

(f)

$$(0.8)^k u[k] + 3(0.4)^k u[-(k+1)]$$

The region of convergence for  $(0.8)^k u[k]$  is  $|z| > 0.8$ . The region of convergence for  $(0.4)^k u[-(k+1)]$  is  $|z| < 0.4$ . The common region does not exist. Hence the  $z$ -transform for this function does not exist.

5.7-2

$$\frac{F[z]}{z} = \frac{e^{-2} - 2}{(z - e^{-2})(z - 2)} = \frac{1}{z - e^{-2}} - \frac{1}{z - 2}$$

$$\text{and } F[z] = \frac{z}{z - e^{-2}} - \frac{z}{z - 2}$$

(a) The region of convergence is  $|z| > 2$ . Both terms are causal. And

$$f[k] = (e^{-2k} - 2^k) u[k]$$

(b) The region of convergence is  $e^{-2} < |z| < 2$ . In this case the 1st term is causal and the second is anticausal.

$$f[k] = e^{-2k} u[k] + 2^k u[-(k+1)]$$

(c) The region of convergence is  $|z| < e^{-2}$ . Both terms are anticausal in this case.

$$f[k] = (-e^{-2k} + 2^k) u[-(k+1)]$$

5.7-3 For causal signals, the region of convergence may be ignored. We shall consider it only for noncausal inputs

(a)

$$Y[z] = F[z]H[z] = \frac{z^2}{(z-e)(z+0.2)(z-0.8)}$$

Modified partial fraction expansion of  $Y[z]$  yields

$$Y[z] = 0.477 \frac{z}{z-e} - 0.068 \frac{z}{z+0.2} - 0.412 \frac{z}{z-0.8}$$

and

$$y[k] = [0.477e^k - 0.068(-0.2)^k - 0.412(0.8)^k] u[k]$$

(b)

$$F[z] = \frac{-z}{z-2} \quad |z| < 2$$

$$H[z] = \frac{z}{(z+0.2)(z-0.8)} \quad |z| > 0.8$$

$$Y[z] = \frac{-z^2}{(z+0.2)(z-0.8)(z-2)} \quad 0.8 < |z| < 2$$

and

$$\frac{Y[z]}{z} = \frac{-z}{(z+0.2)(z-0.8)(z-2)} = \frac{1/11}{z+0.2} + \frac{2/3}{z-0.8} - \frac{0.758}{z-2}$$

$$\text{Therefore } Y[z] = \frac{1}{11} \frac{z}{z+0.2} + \frac{2}{3} \frac{z}{z-0.8} - 0.758 \frac{z}{z-2} \quad 0.8 < |z| < 2$$

$$\text{and } y[k] = \left[ \frac{1}{11}(-0.2)^k + \frac{2}{3}(0.8)^k \right] u[k] + 0.758(2)^k u[-(k+1)]$$

(c) The input in this case is the sum of the inputs in parts a and b hence the response will be the sum of the responses in part a and b.

5.7-4

$$f[k] = \underbrace{2^k u[k]}_{f_1[k]} + \underbrace{u[-(k+1)]}_{f_2[k]}$$

$$F_1[z] = \frac{z}{z-2} \quad |z| > 2$$

$$F_2[z] = \frac{-z}{z-1} \quad |z| < 1$$

There is no region of convergence common to  $F_1[z]$  and  $F_2[z]$

$$H[z] = \frac{z}{(z+0.2)(z-0.8)}$$

The region of convergence of  $H[z]$  is  $|z| > 0.8$  (assuming a causal system). We should find the response to  $f_1[k]$  and  $f_2[k]$  separately.

$$Y_1[z] = \frac{z^2}{(z-2)(z+0.2)(z-0.8)} \quad |z| > 2$$

The modified partial fractions of  $Y[z]$  yield

$$Y_1[z] = -\frac{1}{11} \frac{z}{z+0.2} - \frac{2}{3} \frac{z}{z-0.8} + 0.758 \frac{z}{z-2}$$

and

$$y_1[k] = \left[ -\frac{1}{11}(-0.2)^k - \frac{2}{3}(0.8)^k + 0.758(2)^k \right] u[k]$$

Similarly

$$Y_2[z] = \frac{-25}{6} \frac{z}{z-1} + \frac{1}{6} \frac{z}{z+0.2} + 4 \frac{z}{z-0.8} \quad 0.8 < |z| < 1$$

and

$$y_2[k] = \left[ \frac{1}{6}(-0.2)^k + 4(0.8)^k \right] u[k] + \frac{25}{6} u[-(k+1)]$$

and

$$y[k] = y_1[k] + y_2[k] = \left[ \frac{5}{66}(-0.2)^k + \frac{10}{3}(0.8)^k + 0.758(2)^k \right] u[k] + \frac{25}{6} u[-(k+1)]$$

5.7-5

$$F[z] = \frac{-z}{z-e^2} \quad |z| < e^2$$

and

$$H[z] = \frac{z}{(z+0.2)(z-0.8)} \quad |z| > 0.8$$

No common region of convergence for  $F[z]$  and  $H[z]$  exists. Hence

$$y[k] = \infty$$

## Chapter 6

---

6.1-1 (a)  $T_0 = 4$ ,  $\omega_0 = \frac{2\pi}{T_0} = \frac{\pi}{2}$ . Because of even symmetry, all sine terms are zero.

$$f(t) = a_0 + \sum_{n=1}^{\infty} a_n \cos\left(\frac{n\pi}{2}t\right)$$

$$a_0 = 0 \text{ (by inspection)}$$

$$a_n = \frac{4}{4} \left[ \int_0^1 \cos\left(\frac{n\pi}{2}t\right) dt - \int_1^2 \cos\left(\frac{n\pi}{2}t\right) dt \right] = \frac{4}{n\pi} \sin \frac{n\pi}{2}$$

Therefore, the Fourier series for  $f(t)$  is

$$f(t) = \frac{4}{\pi} \left( \cos \frac{\pi t}{2} - \frac{1}{3} \cos \frac{3\pi t}{2} + \frac{1}{5} \cos \frac{5\pi t}{2} - \frac{1}{7} \cos \frac{7\pi t}{2} + \dots \right)$$

Here  $b_n = 0$ , and we allow  $C_n$  to take negative values. Figure S6.1-1a shows the plot of  $C_n$ .

(b)  $T_0 = 10\pi$ ,  $\omega_0 = \frac{2\pi}{T_0} = \frac{1}{5}$ . Because of even symmetry, all the sine terms are zero.

$$f(t) = a_0 + \sum_{n=1}^{\infty} a_n \cos\left(\frac{n}{5}t\right) + b_n \sin\left(\frac{n}{5}t\right)$$

$$a_0 = \frac{1}{5} \text{ (by inspection)}$$

$$a_n = \frac{2}{10\pi} \int_{-\pi}^{\pi} \cos\left(\frac{n}{5}t\right) dt = \frac{1}{5\pi} \left(\frac{5}{n}\right) \sin\left(\frac{n}{5}t\right) \Big|_{-\pi}^{\pi} = \frac{2}{\pi n} \sin\left(\frac{n\pi}{5}\right)$$

$$b_n = \frac{2}{10\pi} \int_{-\pi}^{\pi} \sin\left(\frac{n}{5}t\right) dt = 0 \quad (\text{integrand is an odd function of } t)$$

Here  $b_n = 0$ , and we allow  $C_n$  to take negative values. Note that  $C_n = a_n$  for  $n = 0, 1, 2, 3, \dots$ . Figure S6.1.1b shows the plot of  $C_n$ .

(c)  $T_0 = 2\pi$ ,  $\omega_0 = 1$ .

$$f(t) = a_0 + \sum_{n=1}^{\infty} a_n \cos nt + b_n \sin nt \text{ with } a_0 = 0.5 \text{ (by inspection)}$$

$$a_n = \frac{1}{\pi} \int_0^{2\pi} \frac{t}{2\pi} \cos nt dt = 0$$

$$b_n = \frac{1}{\pi} \int_0^{2\pi} \frac{t}{2\pi} \sin nt dt = -\frac{1}{\pi n}$$

$$f(t) = 0.5 - \frac{1}{\pi} \left( \sin t + \frac{1}{2} \sin 2t + \frac{1}{3} \sin 3t + \frac{1}{4} \sin 4t + \dots \right)$$

$$= 0.5 + \frac{1}{\pi} \left[ \cos\left(t + \frac{\pi}{2}\right) + \frac{1}{2} \cos\left(2t + \frac{\pi}{2}\right) + \frac{1}{3} \cos\left(3t + \frac{\pi}{2}\right) + \dots \right]$$



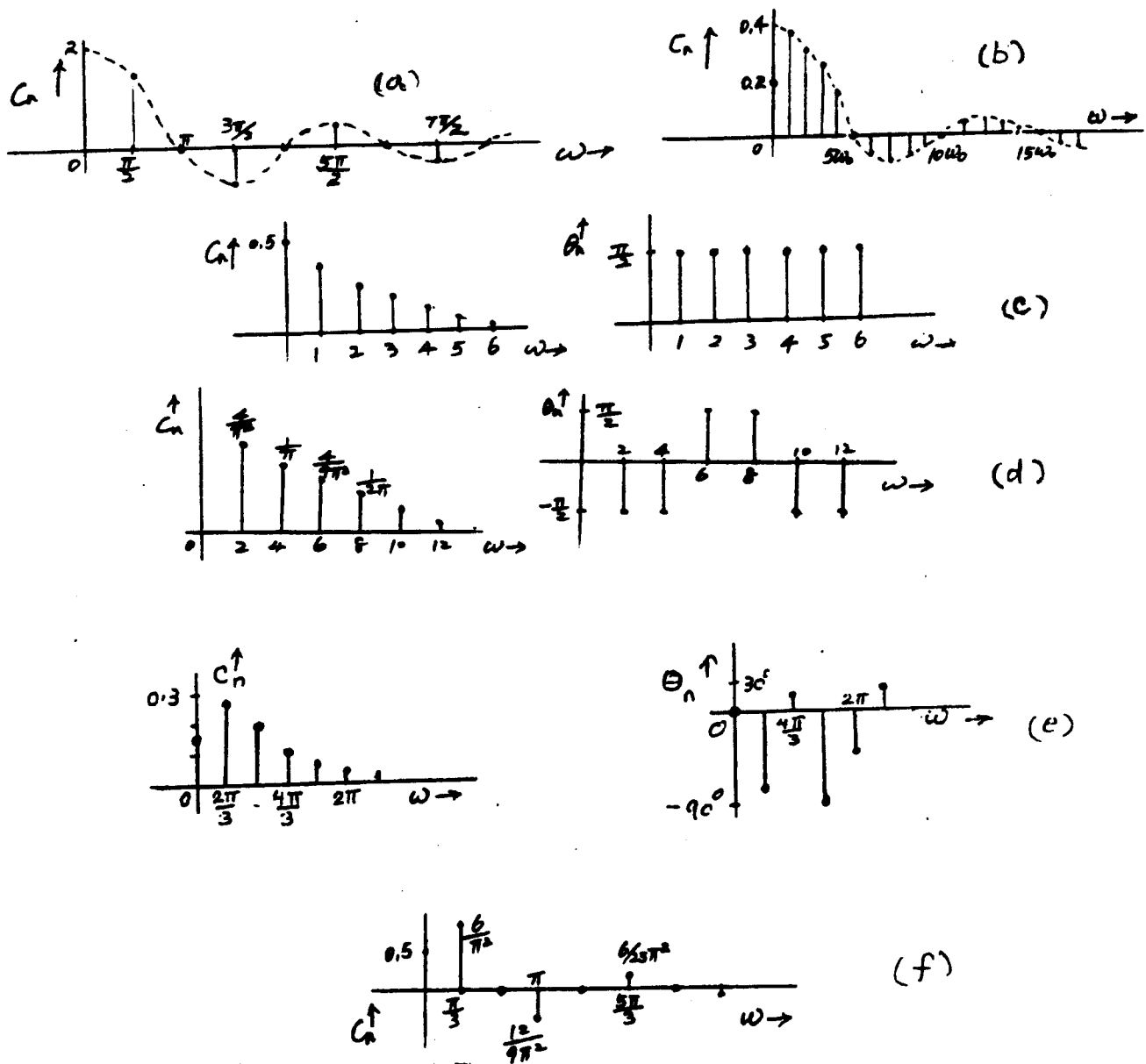

Fig. S6.1-1

The reason for vanishing of the cosines terms is that when 0.5 (the dc component) is subtracted from  $f(t)$ , the remaining function has odd symmetry. Hence, the Fourier series would contain dc and sine terms only. Figure S6.1.1c shows the plot of  $C_n$  and  $\theta_n$ .

(d)  $T_0 = \pi$ ,  $\omega_0 = 2$  and  $f(t) = \frac{4}{\pi}t$ .

$a_0 = 0$  (by inspection).

$a_n = 0$  ( $n > 0$ ) because of odd symmetry.

$$b_n = \frac{4}{\pi} \int_0^{\pi/4} \frac{4}{\pi} t \sin 2nt \, dt = \frac{2}{\pi n} \left( \frac{2}{\pi n} \sin \frac{\pi n}{2} - \cos \frac{\pi n}{2} \right)$$

$$\begin{aligned} f(t) &= \frac{4}{\pi^2} \sin 2t + \frac{1}{\pi} \sin 4t - \frac{4}{9\pi^2} \sin 6t - \frac{1}{2\pi} \sin 8t + \dots \\ &= \frac{4}{\pi^2} \cos \left( 2t - \frac{\pi}{2} \right) + \frac{1}{\pi} \cos \left( 4t - \frac{\pi}{2} \right) + \frac{4}{9\pi^2} \cos \left( 6t + \frac{\pi}{2} \right) + \frac{1}{\pi} \cos \left( 8t + \frac{\pi}{2} \right) + \dots \end{aligned}$$

Figure S6.1.1d shows the plot of  $C_n$  and  $\theta_n$ .

(e)  $T_0 = 3, \omega_0 = 2\pi/3$ .

$$a_0 = \frac{1}{3} \int_0^1 t \, dt = \frac{1}{6}$$

$$a_n = \frac{2}{3} \int_0^1 t \cos \frac{2n\pi}{3} t \, dt = \frac{3}{2\pi^2 n^2} \left[ \cos \frac{2n\pi}{3} + \frac{2n\pi}{3} \sin \frac{2n\pi}{3} - 1 \right]$$

$$b_n = \frac{2}{3} \int_0^1 t \sin \frac{2n\pi}{3} t \, dt = \frac{3}{2\pi^2 n^2} \left[ \sin \frac{2n\pi}{3} - \frac{2n\pi}{3} \cos \frac{2n\pi}{3} \right]$$

Therefore  $C_0 = \frac{1}{6}$  and

$$C_n = \frac{3}{2\pi^2 n^2} \left[ \sqrt{2 + \frac{4\pi^2 n^2}{9} - 2 \cos \frac{2n\pi}{3} - \frac{4n\pi}{3} \sin \frac{2n\pi}{3}} \right] \quad \text{and} \quad \theta_n = \tan^{-1} \left( \frac{2n\pi \cos \frac{2n\pi}{3} - \sin \frac{2n\pi}{3}}{\cos \frac{2n\pi}{3} + \frac{2n\pi}{3} \sin \frac{2n\pi}{3} - 1} \right)$$

(f)  $T_0 = 6, \omega_0 = \pi/3, a_0 = 5$  (by inspection). Even symmetry;  $b_n = 0$ .

$$\begin{aligned} a_n &= \frac{4}{6} \int_0^3 f(t) \cos \frac{n\pi}{3} t \, dt \\ &= \frac{2}{3} \left[ \int_0^1 \cos \frac{n\pi}{3} t \, dt + \int_1^2 (2-t) \cos \frac{n\pi}{3} t \, dt \right] \\ &= \frac{6}{\pi^2 n^2} \left[ \cos \frac{n\pi}{3} - \cos \frac{2n\pi}{3} \right] \end{aligned}$$

$$f(t) = 0.5 + \frac{6}{\pi^2} \left( \cos \frac{\pi}{3} t - \frac{2}{9} \cos \pi t + \frac{1}{25} \cos \frac{5\pi}{3} t + \frac{1}{49} \cos \frac{7\pi}{3} t + \dots \right)$$

Observe that even harmonics vanish. The reason is that if the dc (0.5) is subtracted from  $f(t)$ , the resulting function has half-wave symmetry. (See Prob. 6.1-2). Figure S6.1.1f shows the plot of  $C_n$ .

6.1-2 (a) For half wave symmetry

$$f(t) = -f\left(t \pm \frac{T_0}{2}\right)$$

and

$$\begin{aligned} a_n &= \frac{2}{T_0} \int_0^{T_0} f(t) \cos n\omega_0 t \, dt \\ &= \frac{2}{T_0} \int_0^{T_0/2} f(t) \cos n\omega_0 t \, dt + \int_{T_0/2}^{T_0} f(t) \cos n\omega_0 t \, dt \end{aligned}$$

Let  $x = t - T_0/2$  in the second integral. This gives

$$\begin{aligned} a_n &= \frac{2}{T_0} \left[ \int_0^{T_0/2} f(t) \cos n\omega_0 t \, dt + \int_0^{T_0/2} f\left(x + \frac{T_0}{2}\right) \cos n\omega_0 \left(x + \frac{T_0}{2}\right) dx \right] \\ &= \frac{2}{T_0} \left[ \int_0^{T_0/2} f(t) \cos n\omega_0 t \, dt + \int_0^{T_0/2} -f(x) [-\cos n\omega_0 x] dx \right] \\ &= \frac{4}{T_0} \left[ \int_0^{T_0/2} f(t) \cos n\omega_0 t \, dt \right] \end{aligned}$$

In a similar way we can show that

$$b_n = \frac{4}{T_0} \int_0^{T_0/2} f(t) \sin n\omega_0 t \, dt$$

(b) (i)  $T_0 = 8, \omega_0 = \frac{\pi}{4}, a_0 = 0$  (by inspection). Half wave symmetry. Hence

$$\begin{aligned}
 a_n &= \frac{4}{8} \left[ \int_0^2 f(t) \cos \frac{n\pi}{4} t dt \right] = \frac{1}{2} \left[ \int_0^2 \frac{t}{2} \cos \frac{n\pi}{4} t dt \right] \\
 &= \frac{4}{n^2 \pi^2} \left( \cos \frac{n\pi}{2} + \frac{n\pi}{2} \sin \frac{n\pi}{2} - 1 \right) \quad (n \text{ odd}) \\
 &= \frac{4}{n^2 \pi^2} \left( \frac{n\pi}{2} \sin \frac{n\pi}{2} - 1 \right) \quad (n \text{ odd})
 \end{aligned}$$

Therefore

$$a_n = \begin{cases} \frac{4}{n^2 \pi^2} \left( \frac{n\pi}{2} - 1 \right) & n = 1, 5, 9, 13, \dots \\ -\frac{4}{n^2 \pi^2} \left( \frac{n\pi}{2} + 1 \right) & n = 3, 7, 11, 15, \dots \end{cases}$$

Similarly

$$b_n = \frac{1}{2} \int_0^2 \frac{t}{2} \sin \frac{n\pi}{4} t dt = \frac{4}{n^2 \pi^2} \left( \sin \frac{n\pi}{2} - \frac{n\pi}{2} \cos \frac{n\pi}{2} \right) = \frac{4}{n^2 \pi^2} \sin \left( \frac{n\pi}{2} \right) \quad (n \text{ odd})$$

and

$$f(t) = \sum_{n=1,3,5,\dots}^{\infty} a_n \cos \frac{n\pi}{4} t + b_n \sin \frac{n\pi}{4} t$$

(ii)  $T_0 = 2\pi$ ,  $\omega_0 = 1$ ,  $a_0 = 0$  (by inspection). Half wave symmetry. Hence

$$f(t) = \sum_{n=1,3,5,\dots}^{\infty} a_n \cos nt + b_n \sin nt$$

$$\begin{aligned}
 a_n &= \frac{2}{\pi} \int_0^{\pi} e^{-t/10} \cos nt dt \\
 &= \frac{2}{\pi} \left[ \frac{e^{-t/10}}{n^2 + 0.01} (-0.1 \cos nt + n \sin nt) \right]_0^{\pi} \quad (n \text{ odd}) \\
 &= \frac{2}{\pi} \left[ \frac{e^{-\pi/10}}{n^2 + 0.01} (0.1) - \frac{1}{n^2 + 0.01} (-0.1) \right] \\
 &= \frac{2}{10\pi(n^2 + 0.01)} (e^{-\pi/10} - 1) = \frac{0.0465}{n^2 + 0.01}
 \end{aligned}$$

and

$$\begin{aligned}
 b_n &= \frac{2}{\pi} \int_0^{\pi} e^{-t/10} \sin nt dt \\
 &= \frac{2}{\pi} \left[ \frac{e^{-t/10}}{n^2 + 0.01} (-0.1 \sin nt - n \cos nt) \right]_0^{\pi} \quad (n \text{ odd}) \\
 &= \frac{2n}{(n^2 + 0.01)} (e^{-\pi/10} - 1) = \frac{1.461n}{n^2 + 0.01}
 \end{aligned}$$

6.1-3

	a	b	c	d	e	f	g	h	i
periodic?	yes	yes	no	yes	no	yes	yes	yes	yes
$\omega_0$	1	1		$\pi$		$\frac{1}{70}$	$\frac{3}{4}$	1	2
period	$2\pi$	$2\pi$		2		$140\pi$	$\frac{2\pi}{3}$	$2\pi$	$\pi$

6.2-1

$$f(t) = \sum_{n=-\infty}^{\infty} D_n e^{jn\omega_0 t} \quad \omega_0 = \frac{2\pi}{T}$$

To determine  $D_n$ , multiply both sides by  $e^{-jn\omega_0 t}$  and integrate over a period  $T_0$ :

$$\int_{T_0} f(t) e^{-jm\omega t} dt = \sum_{n=-\infty}^{\infty} D_n \int_{T_0} e^{jn\omega t} e^{-jm\omega t} dt$$

From the identity in the footnote of p.439, it follows that when  $n \neq m$ , the integral on the right-hand side is zero. Only when  $n = m$ , the integral is nonzero with value  $T_0$ . Therefore only one term on the right-hand side yields a nonzero value  $T_0$  (when  $n = m$ ) and

$$D_m = \frac{1}{T_0} \int_{T_0} f(t) e^{-jm\omega t} dt$$

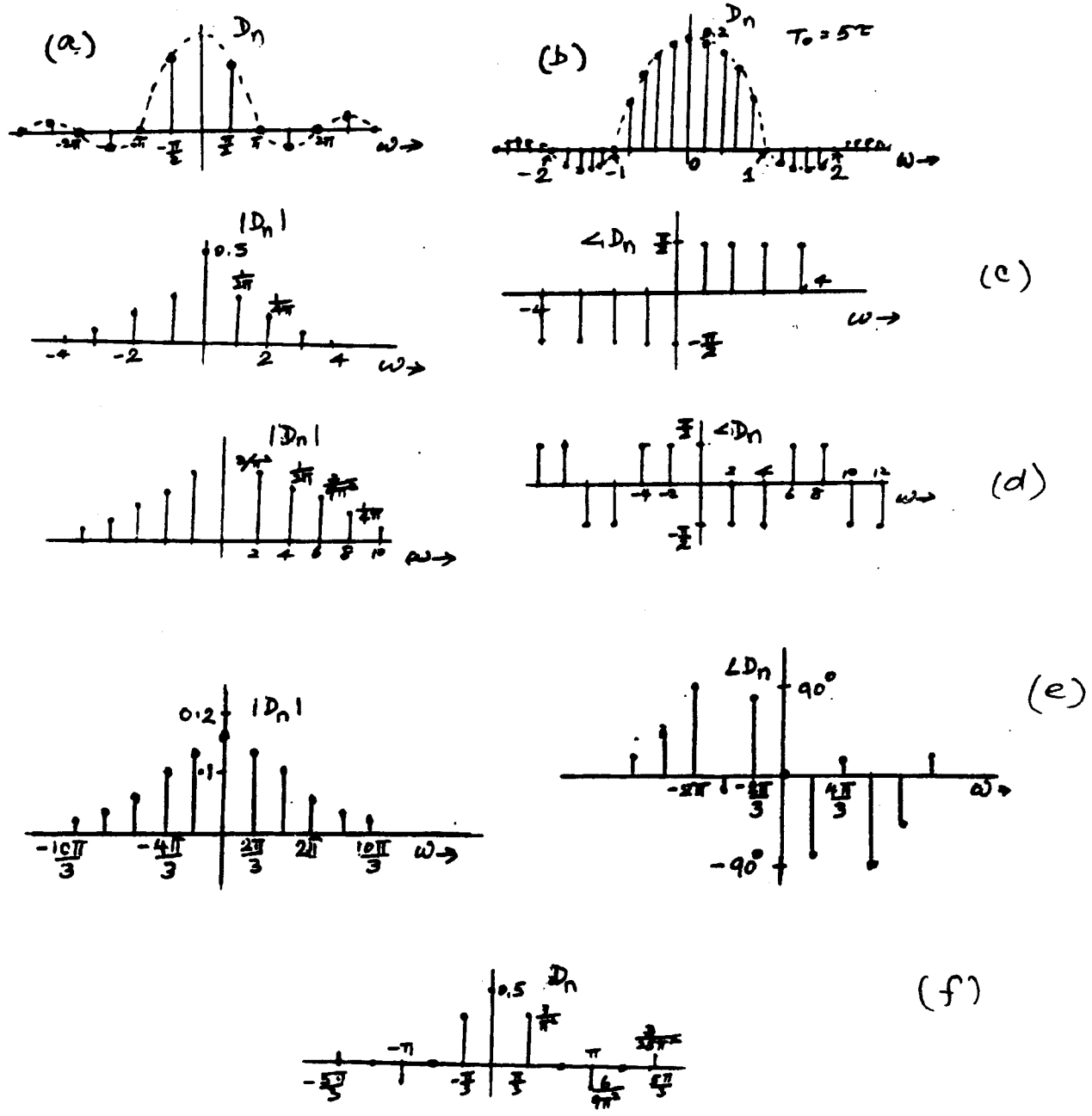

Fig. S6.2-2

6.2-2 (a):  $T_0 = 4, \omega_0 = \pi/2$ . Also  $D_0 = 0$  (by inspection).

$$D_n = \frac{1}{2\pi} \int_{-1}^1 e^{-j(n\pi/2)t} dt - \int_1^3 e^{-j(n\pi/2)t} dt = \frac{2}{\pi n} \sin \frac{n\pi}{2} \quad |n| \geq 1$$

(b)  $T_0 = 10\pi, \omega_0 = 2\pi/10\pi = 1/5$

$$f(t) = \sum_{n=-\infty}^{\infty} D_n e^{jn\frac{t}{5}}$$

$$D_n = \frac{1}{10\pi} \int_{\pi}^{\pi} e^{-jn\frac{t}{5}} dt = \frac{j}{2\pi n} (-2j \sin \frac{n\pi}{5}) = \frac{1}{\pi n} \sin \left(\frac{n\pi}{5}\right)$$

(c)

$$f(t) = D_0 + \sum_{n=-\infty}^{\infty} D_n e^{jn\pi t} \quad D_0 = 0.5$$

$$D_n = \frac{1}{2\pi} \int_0^{2\pi} \frac{t}{2\pi} e^{-jn\pi t} dt = \frac{j}{2\pi n}$$

$$|D_n| = \frac{1}{2\pi n}$$

$$\angle D_n = \begin{cases} \frac{\pi}{2} & n > 0 \\ -\frac{\pi}{2} & n < 0 \end{cases}$$

(d)  $T_0 = \pi, \omega_0 = 2$  and  $D_n = 0$

$$f(t) = \sum_{n=-\infty}^{\infty} D_n e^{j2n\pi t}$$

$$D_n = \frac{1}{\pi} \int_{-\pi/4}^{\pi/4} \frac{4t}{\pi} e^{-j2n\pi t} dt = \frac{-j}{\pi n} \left( \frac{2}{\pi n} \sin \frac{\pi n}{2} - \cos \frac{\pi n}{2} \right)$$

(e)  $T_0 = 3, \omega_0 = \frac{2\pi}{3}$ .

$$f(t) = \sum_{n=-\infty}^{\infty} D_n e^{j\frac{2\pi n}{3}t}$$

$$D_n = \frac{1}{3} \int_0^1 t e^{-j\frac{2\pi n}{3}t} dt = \frac{3}{4\pi^2 n^2} \left[ e^{-j\frac{2\pi n}{3}} \left( \frac{j2\pi n}{3} + 1 \right) - 1 \right]$$

Therefore

$$|D_n| = \frac{3}{4\pi^2 n^2} \left[ \sqrt{2 + \frac{4\pi^2 n^2}{9} - 2 \cos \frac{2\pi n}{3} - \frac{4\pi n}{3} \sin \frac{2\pi n}{3}} \right] \quad \text{and} \quad \angle D_n = \tan^{-1} \left( \frac{\frac{2\pi n}{3} \cos \frac{2\pi n}{3} - \sin \frac{2\pi n}{3}}{\cos \frac{2\pi n}{3} + \frac{2\pi n}{3} \sin \frac{2\pi n}{3} - 1} \right)$$

(f)  $T_0 = 6, \omega_0 = \pi/3, D_0 = 0.5$

$$f(t) = 0.5 + \sum_{n=-\infty}^{\infty} D_n e^{jn\frac{\pi t}{3}}$$

$$D_n = \frac{1}{6} \left[ \int_{-2}^{-1} (t+2) e^{-jn\frac{\pi t}{3}} dt + \int_{-1}^1 e^{-jn\frac{\pi t}{3}} dt + \int_1^2 (-t+2) e^{-jn\frac{\pi t}{3}} dt \right]$$

$$= \frac{3}{\pi^2 n^2} \left( \cos \frac{n\pi}{3} - \cos \frac{2n\pi}{3} \right)$$

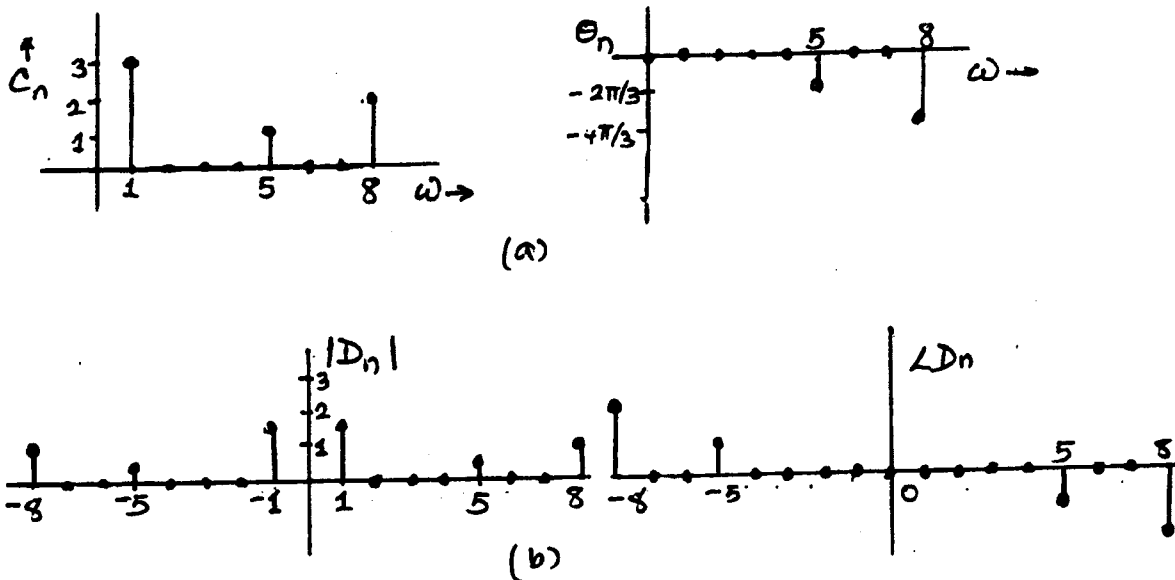

Fig. S6.2-3

6.2-3

$$f(t) = 3 \cos t + \sin \left( 5t - \frac{\pi}{6} \right) - 2 \cos \left( 8t - \frac{\pi}{3} \right)$$

For a compact trigonometric form, all terms must have cosine form and amplitudes must be positive. For this reason, we rewrite  $f(t)$  as

$$\begin{aligned} f(t) &= 3 \cos t + \cos \left( 5t - \frac{\pi}{6} - \frac{\pi}{2} \right) + 2 \cos \left( 8t - \frac{\pi}{3} - \pi \right) \\ &= 3 \cos t + \cos \left( 5t - \frac{2\pi}{3} \right) + 2 \cos \left( 8t - \frac{4\pi}{3} \right) \end{aligned}$$

Figure S6.2-3a shows amplitude and phase spectra.

(b) By inspection of the trigonometric spectra in Fig. S6.2-3a, we plot the exponential spectra as shown in Fig. S6.2-3b. By inspection of exponential spectra in Fig. S6.2-3a, we obtain

$$\begin{aligned} f(t) &= \frac{3}{2} (e^{jt} + e^{-jt}) + \frac{1}{2} \left[ e^{j(5t - \frac{2\pi}{3})} + e^{-j(5t - \frac{2\pi}{3})} \right] + \left[ e^{j(8t - \frac{4\pi}{3})} + e^{-j(8t - \frac{4\pi}{3})} \right] \\ &= \frac{3}{2} e^{jt} + \left( \frac{1}{2} e^{-j\frac{2\pi}{3}} \right) e^{j5t} + \left( e^{-j\frac{4\pi}{3}} \right) e^{j8t} + \frac{3}{2} e^{-jt} + \left( \frac{1}{2} e^{j\frac{2\pi}{3}} \right) e^{-j5t} + \left( e^{j\frac{4\pi}{3}} \right) e^{-j8t} \end{aligned}$$

6.2-4 In compact trigonometric form, all terms are of cosine form and amplitudes are positive. We can express  $f(t)$  as

$$\begin{aligned} f(t) &= 3 + 2 \cos \left( 2t - \frac{\pi}{6} \right) + \cos \left( 3t - \frac{\pi}{2} \right) + \frac{1}{2} \cos \left( 5t + \frac{\pi}{3} - \pi \right) \\ &= 3 + 2 \cos \left( 2t - \frac{\pi}{6} \right) + \cos \left( 3t - \frac{\pi}{2} \right) + \frac{1}{2} \cos \left( 5t - \frac{2\pi}{3} \right) \end{aligned}$$

From this expression we sketch the trigonometric Fourier spectra as shown in Fig. S6.2-4a. By inspection of these spectra, we sketch the exponential Fourier spectra shown in Fig. S6.2-4b. From these exponential spectra, we can now write the exponential Fourier series as

$$f(t) = 3 + e^{j(2t - \frac{\pi}{6})} + e^{-j(2t - \frac{\pi}{6})} + \frac{1}{2} e^{j(3t - \frac{\pi}{2})} + \frac{1}{2} e^{-j(3t - \frac{\pi}{2})} + \frac{1}{4} e^{j(5t - \frac{2\pi}{3})} + \frac{1}{4} e^{-j(5t - \frac{2\pi}{3})}$$

6.2-5 (a) The exponential Fourier series can be expressed with coefficients in Polar form as

$$f(t) = (2\sqrt{2}e^{j\pi/4})e^{-j3t} + 2e^{j\pi/2}e^{-jt} + 3 + 2e^{-j\pi/2}e^{jt} + (2\sqrt{2}e^{-j\pi/4})e^{j3t}$$

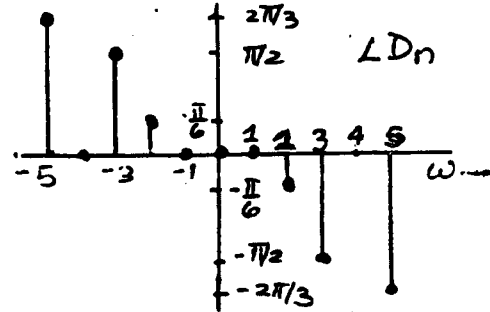
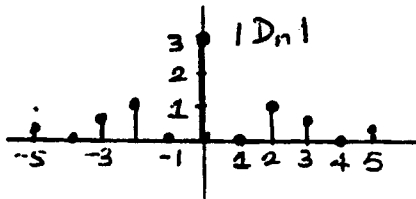
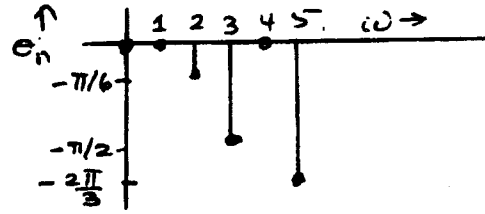
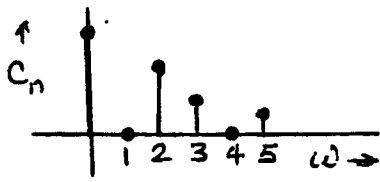

Fig. S6.2-4

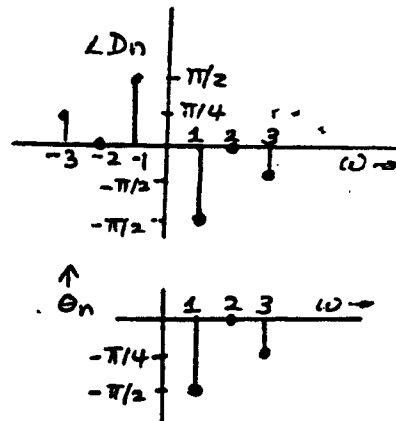
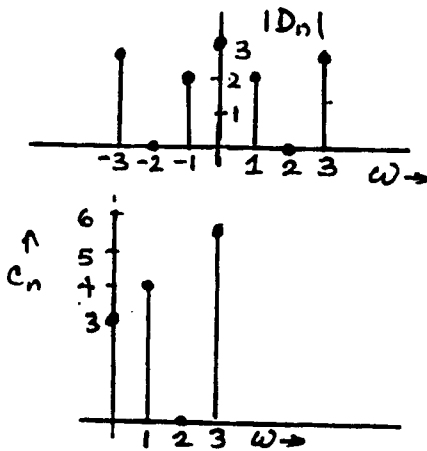

Fig. S6.2-5

From this expression the exponential Spectra are sketched as shown in Fig. S6.2-5a.

(b) By inspection of the exponential spectra in Fig. S6.2-5a, we sketch the trigonometric spectra as shown in Fig. S6.2-5b. From these spectra, we can write the compact trigonometric Fourier series as

$$f(t) = 3 + 4 \cos\left(t - \frac{\pi}{2}\right) + 4\sqrt{2} \cos\left(3t - \frac{\pi}{4}\right)$$

(c) The lowest frequency in the spectrum is 0 and the highest frequency is 3. Therefore the bandwidth is 3 rad/s or  $\frac{3}{2\pi}$  Hz.

6.2-6 (a)

$$\begin{aligned} f(t) &= 2 + 2 \cos(2t - \pi) + \cos\left(3t - \frac{\pi}{2}\right) \\ &= 2 - 2 \cos 2t + \sin 3t \end{aligned}$$

(b) The exponential spectra are shown in Fig. S6.2-6.

(c) By inspection of exponential spectra

$$\begin{aligned} f(t) &= 2 + [e^{j(2t-\pi)} + e^{-j(2t-\pi)}] + \frac{1}{2} [e^{j(3t-\frac{\pi}{2})} + e^{-j(3t-\frac{\pi}{2})}] \\ &= 2 + 2 \cos(2t - \pi) + \cos\left(3t - \frac{\pi}{2}\right) \end{aligned}$$

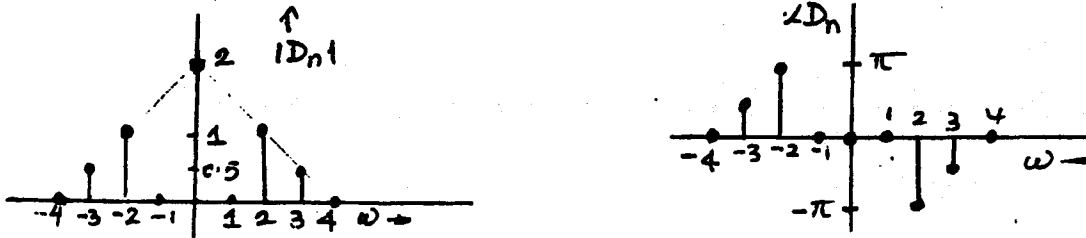

Fig. S6.2-6

(d) Observe that the two expressions (trigonometric and exponential Fourier series) are equivalent.

6.2-7 (a)

$$f(t) = 2 + 2e^{j(t + \frac{2\pi}{3})} + 2e^{-j(t + \frac{2\pi}{3})} + e^{j(2t + \frac{\pi}{3})} + e^{-j(2t + \frac{\pi}{3})}$$

$$= 2 + 4 \cos\left(t + \frac{2\pi}{3}\right) + 2 \cos\left(2t + \frac{\pi}{3}\right)$$

(b) The trigonometric spectra can be sketches by inspection of exponential spectra. This shown in Fig. S6.2-7.

(c) By inspection of the trigonometric spectra

$$f(t) = 2 + 4 \cos\left(t + \frac{2\pi}{3}\right) + 2 \cos\left(2t + \frac{\pi}{3}\right)$$

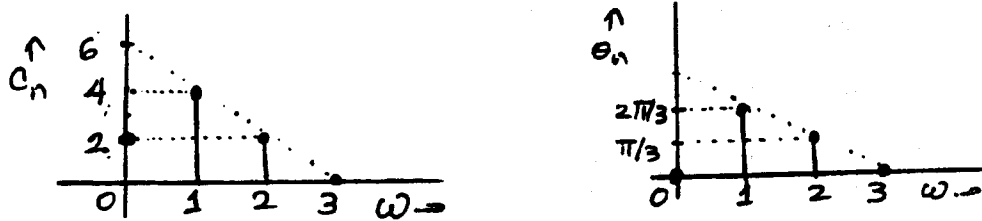

Fig. S6.2-7

6.2-8 The period is  $T_0 = 8$  and  $\omega_0 = \pi/4$ . Also  $D_0 = 0$  (by inspection), and

$$f(t) = \sum_{n=-\infty}^{\infty} D_n e^{jn\frac{\pi}{4}t}$$

$$D_n = \frac{1}{8} \left[ \int_{-4}^0 \left(\frac{t}{2} + 1\right) e^{-j2n(\pi/4)t} dt + \int_0^4 \left(-\frac{t}{2} + 1\right) e^{-j2n(\pi/4)t} dt \right] =$$

This yields

$$D_n = \begin{cases} \frac{16}{\pi^2 n^2} & n = \pm 1, \pm 3, \pm 5, \pm 7, \dots \\ 0 & \text{otherwise} \end{cases}$$

Therefore

$$f(t) = \sum_{n=-\infty, n \text{ odd}}^{\infty} \frac{16}{\pi^2 n^2} e^{jn\frac{\pi}{4}t}$$

(b) Observe that  $f(t)$  is the same as  $f(t)$  in Fig. P6.2-a delayed by 2 seconds. Therefore

$$f(t) = f(t-2) = \sum_{n=-\infty, n \text{ odd}}^{\infty} D_n e^{jn\frac{\pi}{4}(t-2)} = \sum_{n=-\infty, n \text{ odd}}^{\infty} D_n e^{-jn\pi/2} e^{jn\frac{\pi}{4}t}$$

Therefore

$$f(t) = \sum_{n=-\infty, n \text{ odd}}^{\infty} \hat{D}_n e^{jn\frac{\pi}{4}t}$$



where

$$\hat{D}_n = D_n e^{j\frac{\pi}{2}n} = \frac{16}{\pi^2 n^2} e^{-j\frac{\pi}{2}n}$$

(c) Observe that  $\hat{f}(t)$  is the same as  $f(t)$  in Fig. P6.2-a time-compressed by a factor 2. Therefore

$$\hat{f}(t) = f(2t) = \sum_{n=-\infty, n \text{ odd}}^{\infty} D_n e^{jn\frac{\pi}{2}(2t)} = \sum_{n=-\infty, n \text{ odd}}^{\infty} D_n e^{jn\pi t}$$

Therefore

$$\hat{f}(t) = \sum_{n=-\infty, n \text{ odd}}^{\infty} \hat{D}_n e^{jn\pi t}$$

where

$$\hat{D}_n = D_n = \frac{16}{\pi^2 n^2}$$

6.2-9

$$f(t) = \sum_{n=-\infty}^{\infty} D_n e^{jn\omega_0 t}$$

$$\hat{f}(t) = f(t-T) = \sum_{n=-\infty}^{\infty} D_n e^{jn\omega_0(t-T)} = \sum_{n=-\infty}^{\infty} (D_n e^{-jn\omega_0 T}) e^{jn\omega_0 t} = \sum_{n=-\infty}^{\infty} \hat{D}_n e^{jn\omega_0 t}$$

$$\hat{D}_n = D_n e^{-jn\omega_0 T} \quad \text{and} \quad |\hat{D}_n| = |D_n| \quad \angle \hat{D}_n = \angle D_n - jn\omega_0 T$$

6.3-1  $F_1(2, -1)$ ,  $F_2(-1, 2)$ ,  $F_3(0, -2)$ ,  $F_4(1, 2)$ ,  $F_5(2, 1)$ , and  $F_6(3, 0)$ . From the figure, we see that pairs  $(F_3, F_6)$ ,  $(F_1, F_4)$  and  $(F_2, F_5)$  are orthogonal. We can verify this also analytically.

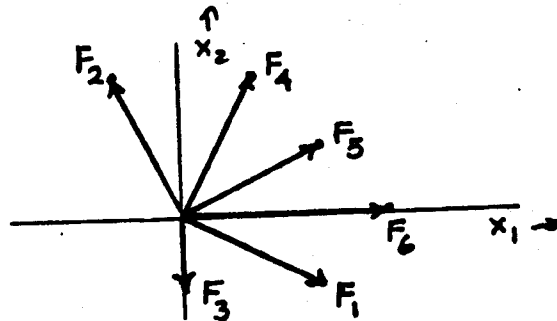

Fig. S6.3-1

$$F_3 \cdot F_6 = (0 \times 3) + (-2 \times 0) = 0$$

$$F_1 \cdot F_4 = (2 \times 1) + (-1 \times 2) = 0$$

$$F_2 \cdot F_5 = (-1 \times 2) + (2 \times 1) = 0$$

6.3-2

$$c(t) = f(t) - cx(t)$$

Also

$$\int_{t_1}^{t_2} x(t)[f(t) - cx(t)] dt = \int_{t_1}^{t_2} f(t)x(t) dt - c \int_{t_1}^{t_2} x^2(t) dt$$

But

$$c = \frac{\int_{t_1}^{t_2} f(t)x(t) dt}{\int_{t_1}^{t_2} x^2(t) dt}$$

Substitution of  $c$  in the earlier equation yields

$$\int_{t_1}^{t_2} x(t)[f(t) - cx(t)] dt = 0$$

Therefore  $x(t)$  and  $[f(t) - cx(t)]$  are orthogonal.

(b) We can readily see result from Fig. 6.15. The error vector  $e$  is orthogonal to vector  $x$ .

(c)

$$e(t) = \begin{cases} 1 - \frac{4}{\pi} \sin t & 0 \leq t \leq \pi \\ -1 - \frac{4}{\pi} \sin t & \pi \leq t \leq 2\pi \end{cases}$$

$$\begin{aligned} \int_0^{2\pi} e^2(t) dt &= \int_0^{\pi} \left(1 - \frac{4}{\pi} \sin t\right)^2 dt - \int_{\pi}^{2\pi} \left(1 + \frac{4}{\pi} \sin t\right)^2 dt \\ &= -\frac{8}{\pi} \left[ \int_0^{\pi} \sin t dt + \int_{\pi}^{2\pi} \sin t dt \right] = -\frac{8}{\pi} \int_0^{2\pi} \sin t dt = 0 \end{aligned}$$

6.3-3

$$f(t) = a_0 + \sum_{n=1}^{\infty} a_n \cos 2\pi n t + b_n \sin 2\pi n t \quad (\omega_0 = \frac{2\pi}{1})$$

$$a_0 = 1 \int_0^1 f(t) dt = \int_0^1 t dt = \frac{1}{2}$$

$$a_n = 2 \int_0^1 t \cos 2\pi n t dt = 0 \quad n \geq 1 \quad (n \text{ integer})$$

$$b_n = 2 \int_0^1 t \sin 2\pi n t dt = \frac{-1}{\pi n}$$

Hence

$$\begin{aligned} f(t) &= \frac{1}{2} - \frac{1}{\pi} \left( \sin 2\pi t + \frac{1}{2} \sin 4\pi t + \frac{1}{3} \sin 6\pi t + \dots \right) \\ &= \frac{1}{2} - \frac{1}{\pi} \sum_{n=1}^{\infty} \frac{1}{n} \sin 2\pi n t \end{aligned}$$

From Eq. (6.73)

$$\epsilon_k = 1 \int_0^1 f^2(t) dt - \left[ \left(\frac{1}{2}\right)^2 + \frac{1}{2} \left[ \left(\frac{1}{\pi}\right)^2 + \left(\frac{1}{2\pi}\right)^2 + \dots + \left(\frac{1}{(k-1)\pi}\right)^2 \right] \right]$$

(Note that  $K_j^2 = 1/2$  for  $j = 1, 2, \dots$  and  $K_0^2 = 1$ )

$$\epsilon_1 = \int_0^1 t^2 dt - \frac{1}{4} = \frac{1}{3} - \frac{1}{4} = \frac{1}{12}$$

$$\epsilon_2 = \frac{1}{3} - \frac{1}{4} - \frac{1}{2\pi^2} = 0.03267$$

$$\epsilon_3 = \frac{1}{3} - \frac{1}{4} - \frac{1}{2\pi^2} - \frac{1}{8\pi^2} = 0.02$$

$$\epsilon_4 = \frac{1}{3} - \frac{1}{4} - \frac{1}{2\pi^2} - \frac{1}{8\pi^2} - \frac{1}{18\pi^2} = 0.014378$$

6.3-4 Figure S6.3-4a shows  $f_1(t)$  that is a periodic extension of  $f(t)$  to yield a series with  $\omega_0 = 2\pi$  and only sine terms. This requires  $T_0 = 2\pi/2\pi = 1$  and odd symmetry. From inspection, the dc component is 0.5. If we subtract dc (0.5) from  $f_1(t)$ , the remaining signal  $f_1(t) - 0.5$  has odd symmetry (only sine terms). Therefore

$$f_1(t) = 0.5 + \sum_{n=1}^{\infty} b_n \sin 2\pi n t$$

$$b_n = 2 \int_0^1 t \sin 2\pi n t dt = -\frac{1}{\pi n}$$

$$f_1(t) = \frac{1}{2} - \frac{1}{\pi} \sum_{n=1}^{\infty} \frac{1}{n} \sin 2\pi n t$$

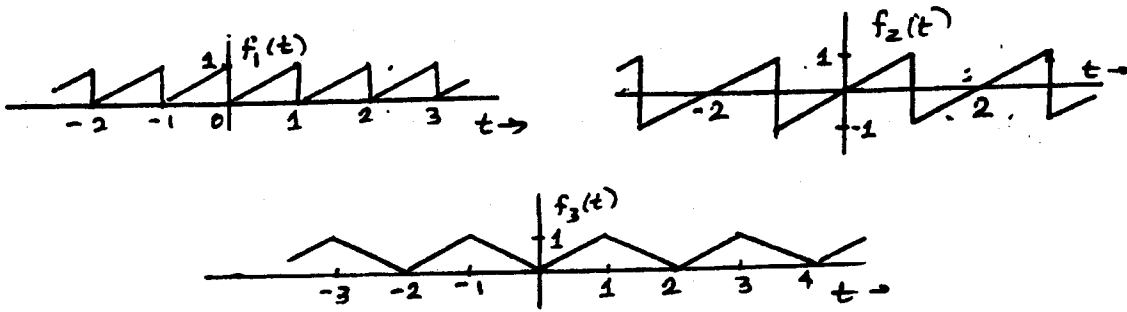

Fig. S6.3-4

(b)  $\omega_0 = \pi$  and  $T_0 = 2\pi/\pi = 2$ . For sine terms only, we need odd symmetry. Figure S6.3-4b shows a suitable function  $f_2(t)$ . It has no dc.

$$f_2(t) = \sum_{n=1}^{\infty} b_n \sin n\pi t$$

$$b_n = \frac{4}{2} \int_0^1 t \sin n\pi t dt = (-1)^{n+1} \frac{2}{n\pi}$$

(c)  $\omega_0 = \pi$ ,  $T_0 = 2\pi/\omega_0 = 2$ . For cosine terms only, we need an even function  $f_3(t)$  as shown in Fig. S6.3-4c. By inspection dc is 0.5. Therefore

$$f_3(t) = \frac{1}{2} + \sum_{n=1}^{\infty} a_n \cos n\pi t$$

$$a_n = \frac{4}{2} \int_0^1 t \cos n\pi t dt = -\frac{4}{\pi^2 n^2} \quad n = 1, 3, 5, \dots$$

6.3-5 (a) The signal  $g(t)$  is the same as the signal  $f(t)$  in Example 6.10 (Fig. 6.21) time-expanded by a factor  $\pi$ . Therefore from Eq. (6.91), we have

$$g(t) = f\left(\frac{t}{\pi}\right) = -\frac{3}{2} \left(\frac{t}{\pi}\right) + \frac{7}{8} \left[\frac{5}{2} \left(\frac{t}{\pi}\right)^2 - \frac{3}{2} \left(\frac{t}{\pi}\right)\right] + \dots \quad (1)$$

For the representation in Eq. (6.91) for  $f(t)$  in Fig. 6.21

$$\int_{-1}^1 f^2(t) dt = 2\pi \quad \text{and}$$

Therefore from Eq. (6.73)

$$e_1 = \int f^2(t) dt - \frac{1}{3} c_1^2 = 2 - \frac{3}{2} = 0.5$$

$$e_2 = \int f^2(t) dt - \frac{1}{3} c_1^2 - \frac{1}{7} c_3^2 = 0.28125$$

Since  $g(t)$  is the same as  $f(t)$  time-expanded by a factor  $\pi$ , all energies are increased by the same factor ( $\pi$ ). Therefore

$$e_1 = 0.5\pi$$

$$e_2 = 0.28125\pi$$

# Chapter 7

7.1-1

$$F(\omega) = \int_{-\infty}^{\infty} f(t)e^{-j\omega t} dt = \int_{-\infty}^{\infty} f(t) \cos \omega t dt - j \int_{-\infty}^{\infty} f(t) \sin \omega t dt$$

If  $f(t)$  is an even function of  $t$ ,  $f(t) \sin \omega t$  is an odd function of  $t$ , and the second integral vanishes. Moreover,  $f(t) \cos \omega t$  is an even function of  $t$ , and the first integral is twice the integral over the interval 0 to  $\infty$ . Thus when  $f(t)$  is even

$$F(\omega) = 2 \int_0^{\infty} f(t) \cos \omega t dt \quad (1)$$

Similar argument shows that when  $f(t)$  is odd

$$F(\omega) = -2j \int_0^{\infty} f(t) \sin \omega t dt \quad (2)$$

If  $f(t)$  is also real (in addition to being even), the integral (1) is real. Moreover from (1)

$$F(-\omega) = 2 \int_0^{\infty} f(t) \cos \omega t dt = F(\omega)$$

Hence  $F(\omega)$  is real and even function of  $\omega$ . Similar arguments can be used to prove the rest of the properties.

7.1-2

$$\begin{aligned} f(t) &= \frac{1}{2\pi} \int_{-\infty}^{\infty} F(\omega) e^{j\omega t} d\omega = \frac{1}{2\pi} \int_{-\infty}^{\infty} |F(\omega)| e^{j\angle F(\omega)} e^{j\omega t} d\omega \\ &= \frac{1}{2\pi} \left[ \int_{-\infty}^{\infty} |F(\omega)| \cos[\omega t + \angle F(\omega)] d\omega + j \int_{-\infty}^{\infty} |F(\omega)| \sin[\omega t + \angle F(\omega)] d\omega \right] \end{aligned}$$

Since  $|F(\omega)|$  is an even function and  $\angle F(\omega)$  is an odd function of  $\omega$ , the integrand in the second integral is an odd function of  $\omega$ , and therefore vanishes. Moreover the integrand in the first integral is an even function of  $\omega$ , and therefore

$$f(t) = \frac{1}{\pi} \int_0^{\infty} |F(\omega)| \cos[\omega t + \angle F(\omega)] d\omega$$

7.1-3 Because  $f(t) = f_o(t) + f_e(t)$  and  $e^{-j\omega t} = \cos \omega t + j \sin \omega t$

$$F(\omega) = \int_{-\infty}^{\infty} [f_o(t) + f_e(t)] e^{-j\omega t} dt = \int_{-\infty}^{\infty} [f_o(t) + f_e(t)] \cos \omega t dt - j \int_{-\infty}^{\infty} [f_o(t) + f_e(t)] \sin \omega t dt$$

Because  $f_e(t) \cos \omega t$  and  $f_o(t) \sin \omega t$  are even functions and  $f_o(t) \cos \omega t$  and  $f_e(t) \sin \omega t$  are odd functions of  $t$ , these integrals [properties in Eqs. (B.43), p. 38] reduce to

$$F(\omega) = 2 \int_0^{\infty} f_e(t) \cos \omega t dt - 2j \int_0^{\infty} f_o(t) \sin \omega t dt \quad (1)$$

Also, from the results of Prob. 7.1-1, we have

$$\mathcal{F}\{f_e(t)\} = 2 \int_0^{\infty} f_e(t) \cos \omega t dt \quad \text{and} \quad \mathcal{F}\{f_o(t)\} = -2j \int_0^{\infty} f_o(t) \sin \omega t dt \quad (2)$$

From Eqs. (1) and (2), the desired result follows.

7.1-4 (a)

$$F(\omega) = \int_0^T e^{-at} e^{-j\omega t} dt = \int_0^T e^{-(j\omega+a)t} dt = \frac{1 - e^{-(j\omega+a)T}}{j\omega + a}$$

(b)

$$F(\omega) = \int_0^T e^{at} e^{-j\omega t} dt = \int_0^T e^{-(j\omega - a)t} dt = \frac{1 - e^{-(j\omega - a)T}}{j\omega - a}$$

7.1-5 (a)

$$F(\omega) = \int_0^1 4e^{-j\omega t} dt + \int_1^2 2e^{-j\omega t} dt = \frac{4 - 2e^{-j\omega} - 2e^{-j2\omega}}{j\omega}$$

(b)

$$F(\omega) = \int_{-r}^0 -\frac{t}{r} e^{-j\omega t} dt = \int_0^r \frac{t}{r} e^{-j\omega t} dt = \frac{2}{r\omega^2} [\cos \omega r + \omega r \sin \omega r - 1]$$

This result could also be derived by observing that  $f(t)$  is an even function. Therefore from the result in Prob. 7.1-1

$$F(\omega) = \frac{2}{r} \int_0^r t \cos \omega t dt = \frac{2}{r\omega^2} [\cos \omega r + \omega r \sin \omega r - 1]$$

7.1-6 (a)

$$f(t) = \frac{1}{2\pi} \int_{-\omega_0}^{\omega_0} \omega^2 e^{j\omega t} d\omega = \frac{1}{2\pi} \frac{e^{j\omega t}}{(jt)^3} [-\omega^2 t^2 - 2j\omega t + 2] \Big|_{-\omega_0}^{\omega_0} = \frac{(\omega_0^2 t^2 - 2) \sin \omega_0 t + 2\omega_0 t \cos \omega_0 t}{\pi t^3}$$

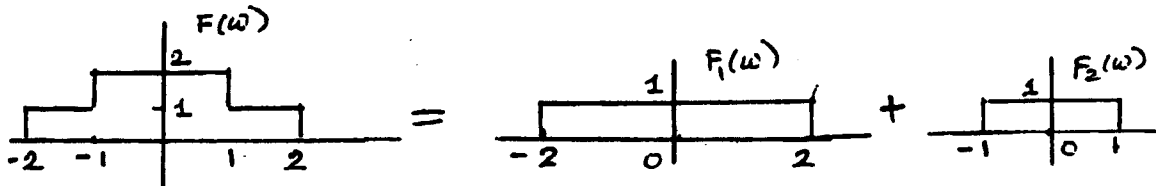

Fig. S7.1-6b

(b) The derivation can be simplified by observing that  $F(\omega)$  can be expressed as a sum of two gate functions  $F_1(\omega)$  and  $F_2(\omega)$  as shown in Fig. S7.1-6. Therefore

$$f(t) = \frac{1}{2\pi} \int_{-2}^2 [F_1(\omega) + F_2(\omega)] e^{j\omega t} d\omega = \frac{1}{2\pi} \left\{ \int_{-2}^2 e^{j\omega t} d\omega + \int_{-1}^1 e^{j\omega t} d\omega \right\} = \frac{\sin 2t + \sin t}{\pi t}$$

7.1-7 (a)

$$\begin{aligned} f(t) &= \frac{1}{2\pi} \int_{-\pi/2}^{\pi/2} \cos \omega e^{j\omega t} d\omega = \frac{1}{4\pi} \int_{-\pi/2}^{\pi/2} [e^{j\omega(1+t)} + e^{-j\omega(1-t)}] d\omega \\ &= \frac{1}{2\pi} \left\{ \frac{\sin[(t+1)\pi/2]}{t+1} + \frac{\sin[(t-1)\pi/2]}{t-1} \right\} \end{aligned}$$

(b)

$$f(t) = \frac{1}{2\pi} \int_{-\pi/2}^{\pi/2} F(\omega) e^{j\omega t} d\omega = \frac{1}{2\pi} \left[ \int_{-\pi/2}^{\pi/2} F(\omega) \cos \omega t d\omega + j \int_{-\pi/2}^{\pi/2} F(\omega) \sin \omega t d\omega \right]$$

Because  $F(\omega)$  is even function, the second integral on the right-hand side vanishes. Also the integrand of the first term is an even function. Therefore

$$\begin{aligned} f(t) &= \frac{1}{\pi} \int_0^{\pi/2} \frac{\omega}{\omega_0} \cos \omega t d\omega = \frac{1}{\pi \omega_0} \left[ \frac{\cos \omega t + \omega t \sin \omega t}{t^2} \right]_0^{\omega_0} \\ &= \frac{1}{\pi \omega_0 t^2} [\cos \omega_0 t + \omega_0 t \sin \omega_0 t - 1] \end{aligned}$$

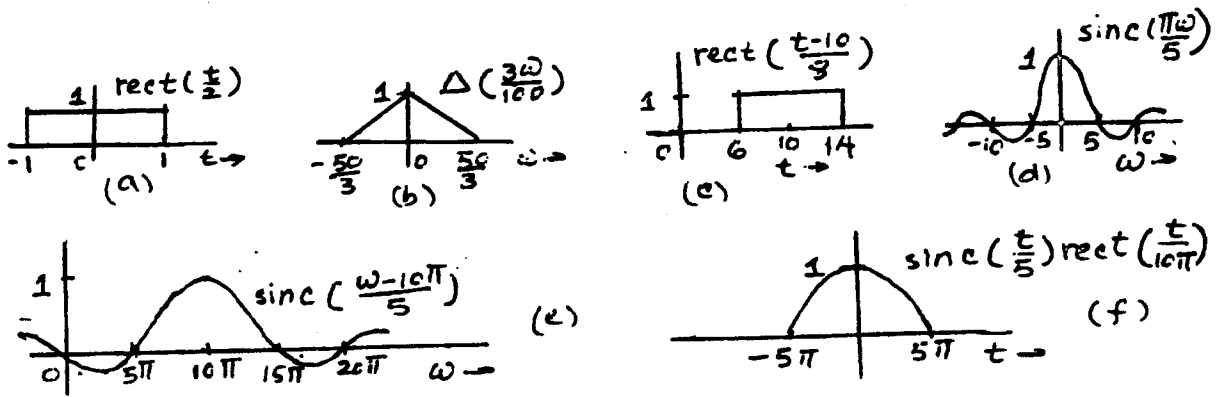

Fig. S7.3-1

7.3-1 Figure S7.3-1 shows the plots of various functions. The function in part (a) is a gate function centered at the origin and of width 2. The function in part (b) can be expressed as  $\Delta\left(\frac{3\omega}{100}\right)$ . This is a triangle pulse centered at the origin and of width  $100/3$ . The function in part (c) is a gate function  $\text{rect}\left(\frac{t}{8}\right)$  delayed by 10. In other words it is a gate pulse centered at  $t = 10$  and of width 8. The function in part (d) is a sinc pulse centered at the origin and the first zero occurring at  $\frac{\pi\omega}{5} = \pi$ , that is at  $\omega = 5$ . The function in part (e) is a sinc pulse  $\text{sinc}\left(\frac{\omega}{5}\right)$  delayed by  $10\pi$ . For the sinc pulse  $\text{sinc}\left(\frac{\omega}{5}\right)$ , the first zero occurs at  $\frac{\omega}{5} = \pi$ , that is at  $\omega = 5\pi$ . Therefore the function is a sinc pulse centered at  $\omega = 10\pi$  and its zeros spaced at intervals of  $5\pi$  as shown in the fig. S7.3-1e. The function in part (f) is a product of a gate pulse (centered at the origin) of width  $10\pi$  and a sinc pulse (also centered at the origin) with zeros spaced at intervals of  $5\pi$ . This results in the sinc pulse truncated beyond the interval  $\pm 5\pi$  ( $|t| \geq 5\pi$ ) as shown in Fig. f.

7.3-2

$$\begin{aligned} F(\omega) &= \int_{4.5}^{5.5} e^{-j\omega t} dt = -\frac{1}{j\omega} e^{-j\omega t} \Big|_{4.5}^{5.5} = \frac{1}{j\omega} [e^{-j\omega 4.5} - e^{-j\omega 5.5}] \\ &= \frac{e^{-j\omega 5}}{j\omega} [e^{j\omega/2} - e^{-j\omega/2}] = \frac{e^{-j\omega 5}}{j\omega} [2j \sin \frac{\omega}{2}] \\ &= \text{sinc}\left(\frac{\omega}{2}\right) e^{-j\omega 5} \end{aligned}$$

7.3-3

$$\begin{aligned} f(t) &= \frac{1}{2\pi} \int_{10-\pi}^{10+\pi} e^{j\omega t} d\omega = \frac{e^{j\omega t}}{2\pi(j\omega)} \Big|_{10-\pi}^{10+\pi} = \frac{1}{j2\pi\omega} [e^{j(10+\pi)t} - e^{j(10-\pi)t}] \\ &= \frac{e^{j10t}}{j2\pi\omega} [2j \sin \pi t] = \text{sinc}(\pi t) e^{j10t} \end{aligned}$$

7.3-4 (a)

$$\begin{aligned} f(t) &= \frac{1}{2\pi} \int_{-\omega_0}^{\omega_0} e^{-j\omega t_0} e^{j\omega t} d\omega = \frac{1}{2\pi} \int_{-\omega_0}^{\omega_0} e^{j\omega(t-t_0)} d\omega \\ &= \frac{1}{(2\pi)j(t-t_0)} e^{j\omega(t-t_0)} \Big|_{-\omega_0}^{\omega_0} = \frac{\sin \omega_0(t-t_0)}{\pi(t-t_0)} = \frac{\omega_0}{\pi} \text{sinc}[\omega_0(t-t_0)] \end{aligned}$$

(b)

$$\begin{aligned} f(t) &= \frac{1}{2\pi} \left[ \int_{-\omega_0}^0 j e^{j\omega t} d\omega + \int_0^{\omega_0} -j e^{j\omega t} d\omega \right] \\ &= \frac{1}{2\pi t} e^{j\omega t} \Big|_{-\omega_0}^0 - \frac{1}{2\pi t} e^{j\omega t} \Big|_0^{\omega_0} = \frac{1 - \cos \omega_0 t}{\pi t} \end{aligned}$$

7.4-1 (a)

$$\underbrace{u(t)}_{f(t)} \longleftrightarrow \underbrace{\pi\delta(\omega) + \frac{1}{j\omega}}_{F(\omega)}$$

Application of duality property yields

$$\underbrace{\pi\delta(t) + \frac{1}{jt}}_{F(t)} \longleftrightarrow \underbrace{2\pi u(-\omega)}_{2\pi f(-\omega)}$$

or

$$\frac{1}{2} \left[ \delta(t) + \frac{1}{j\pi t} \right] \longleftrightarrow u(-\omega)$$

Application of Eq. (7.35) yields

$$\frac{1}{2} \left[ \delta(-t) - \frac{1}{j\pi t} \right] \longleftrightarrow u(\omega)$$

But  $\delta(t)$  is an even function, that is  $\delta(-t) = \delta(t)$ , and

$$\frac{1}{2} \left[ \delta(t) + \frac{2}{\pi t} \right] \longleftrightarrow u(\omega)$$

(b)

$$\underbrace{\text{sgn}(t)}_{f(t)} \longleftrightarrow \underbrace{\frac{2}{j\omega}}_{F(\omega)}$$

Therefore from duality property

$$\underbrace{\frac{2}{jt}}_{F(t)} \longleftrightarrow \underbrace{2\pi \text{sgn}(-\omega)}_{2\pi f(-\omega)} = -2\pi \text{sgn}(\omega)$$

and

$$\frac{1}{t} \longleftrightarrow -j\pi \text{sgn}(\omega)$$

(c)

$$\underbrace{\cos \omega_0 t}_{f(t)} \longleftrightarrow \underbrace{\pi[\delta(\omega + \omega_0) + \delta(\omega - \omega_0)]}_{F(\omega)}$$

Application of duality property yields

$$\underbrace{\pi[\delta(t + \omega_0) + \delta(t - \omega_0)]}_{F(t)} \longleftrightarrow \underbrace{2\pi \cos(-\omega_0 \omega)}_{2\pi f(-\omega)} = 2\pi \cos(\omega_0 \omega)$$

Setting  $\omega_0 = T$  yields

$$\delta(t + T) + \delta(t - T) \longleftrightarrow 2 \cos T\omega$$

(d)

$$\underbrace{\sin \omega_0 t}_{f(t)} \longleftrightarrow \underbrace{j\pi[\delta(\omega + \omega_0) - \delta(\omega - \omega_0)]}_{F(\omega)}$$

Application of duality property yields

$$\underbrace{j\pi[\delta(t + \omega_0) - \delta(t - \omega_0)]}_{F(t)} \longleftrightarrow \underbrace{2\pi \sin(-\omega_0 \omega)}_{2\pi f(-\omega)} = -2\pi \sin(\omega_0 \omega)$$

Setting  $\omega_0 = T$  yields

$$\delta(t + T) - \delta(t - T) \longleftrightarrow 2j \sin T\omega$$

7.4-2 Fig. (b)  $f_1(t) = f(-t)$  and

$$F_1(\omega) = F(-\omega) = \frac{1}{\omega^2} [e^{-j\omega} + j\omega e^{-j\omega} - 1]$$

Fig. (c)  $f_3(t) = f(t-1) + f_1(t-1)$ . Therefore

$$\begin{aligned} F_3(\omega) &= [F(\omega) + F_1(\omega)]e^{-j\omega} = [F(\omega) + F(-\omega)]e^{-j\omega} \\ &= \frac{2}{\omega^2}(\cos \omega + \omega \sin \omega - 1) \end{aligned}$$

Fig. (d)  $f_4(t) = f(t-1) + f_1(t+1)$

$$\begin{aligned} F_4(\omega) &= F(\omega)e^{-j\omega} + F(-\omega)e^{j\omega} \\ &= \frac{1}{\omega^2}[2 - 2\cos \omega] = \frac{4}{\omega^2} \sin^2 \frac{\omega}{2} = \text{sinc}^2 \left( \frac{\omega}{2} \right) \end{aligned}$$

Fig. (e)  $f_2(t) = f(t - \frac{1}{2}) + f_1(t + \frac{1}{2})$ , and

$$\begin{aligned} F_2(\omega) &= F(\omega)e^{-j\omega/2} + F_1(\omega)e^{j\omega/2} \\ &= \frac{e^{-j\omega/2}}{\omega^2}[e^{j\omega} - j\omega e^{j\omega} - 1] + \frac{e^{j\omega/2}}{\omega^2}[e^{-j\omega} + j\omega e^{-j\omega} - 1] \\ &= \frac{1}{\omega^2}[2\omega \sin \frac{\omega}{2}] = \text{sinc} \left( \frac{\omega}{2} \right) \end{aligned}$$

Fig. (f)  $f_5(t)$  can be obtained in three steps: (i) time-expanding  $f(t)$  by a factor 2 (ii) then delaying it by 2 seconds, (iii) and multiplying it by 1.5 [we may interchange the sequence for steps (i) and (ii)]. The first step (time-expansion by a factor 2) yields

$$f\left(\frac{t}{2}\right) \iff 2F(2\omega) = \frac{1}{2\omega^2}(e^{j2\omega} - j2\omega e^{j2\omega} - 1)$$

Second step of time delay of 2 secs. yields

$$f\left(\frac{t-2}{2}\right) \iff \frac{1}{2\omega^2}(e^{j2\omega} - j2\omega e^{j2\omega} - 1)e^{-j2\omega} = \frac{1}{2\omega^2}(1 - j2\omega - e^{-j2\omega})$$

The third step of multiplying the resulting signal by 1.5 yields

$$f_5(t) = 1.5 f\left(\frac{t-2}{2}\right) \iff \frac{1.5}{2\omega^2}(1 - j2\omega - e^{-j2\omega})$$

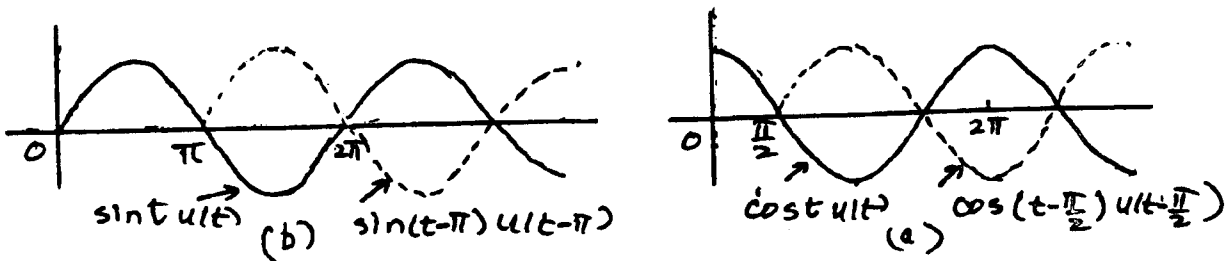

Fig. S7.4-3

7.4-3 (a)

$$f(t) = \text{rect}\left(\frac{t+T/2}{T}\right) - \text{rect}\left(\frac{t-T/2}{T}\right)$$

$$\text{rect}\left(\frac{t}{T}\right) \iff T \text{sinc}\left(\frac{\omega T}{2}\right)$$

$$\text{rect}\left(\frac{t \pm T/2}{T}\right) \iff T \text{sinc}\left(\frac{\omega T}{2}\right) e^{\pm j\omega T/2}$$

and



$$\begin{aligned}
 F(\omega) &= T \operatorname{sinc} \left( \frac{\omega T}{2} \right) [e^{j\omega T/2} - e^{-j\omega T/2}] \\
 &= 2jT \operatorname{sinc} \left( \frac{\omega T}{2} \right) \sin \frac{\omega T}{2} \\
 &= \frac{j^4}{\omega} \sin^2 \left( \frac{\omega T}{2} \right)
 \end{aligned}$$

(b) From Fig. S7.4-3b we verify that

$$f(t) = \sin t u(t) + \sin(t - \pi) u(t - \pi)$$

Note that  $\sin(t - \pi)u(t - \pi)$  is  $\sin t u(t)$  delayed by  $\pi$ . Now

$$\sin t u(t) \longleftrightarrow \frac{\pi}{2j} [\delta(\omega - 1) - \delta(\omega + 1)] + \frac{1}{1 - \omega^2} \quad \text{and} \quad \sin(t - \pi)u(t - \pi) \longleftrightarrow \left\{ \frac{\pi}{2j} [\delta(\omega - 1) - \delta(\omega + 1)] + \frac{1}{1 - \omega^2} \right\} e^{-j\pi\omega}$$

Therefore

$$F(\omega) = \left\{ \frac{\pi}{2j} [\delta(\omega - 1) - \delta(\omega + 1)] + \frac{1}{1 - \omega^2} \right\} (1 + e^{-j\pi\omega})$$

Recall that  $f(x)\delta(x - x_0) = f(x_0)\delta(x - x_0)$ . Therefore  $\delta(\omega \pm 1)(1 + e^{-j\pi\omega}) = 0$ , and

$$F(\omega) = \frac{1}{1 - \omega^2} (1 + e^{-j\pi\omega})$$

(c) From Fig. S7.4-3c we verify that

$$f(t) = \cos t \left[ u(t) - u \left( t - \frac{\pi}{2} \right) \right] = \cos t u(t) - \cos t u \left( t - \frac{\pi}{2} \right)$$

But  $\sin(t - \frac{\pi}{2}) = -\cos t$ . Therefore

$$\begin{aligned}
 f(t) &= \cos t u(t) + \sin \left( t - \frac{\pi}{2} \right) u \left( t - \frac{\pi}{2} \right) \\
 F(\omega) &= \frac{\pi}{2} [\delta(\omega - 1) + \delta(\omega + 1)] + \frac{j\omega}{1 - \omega^2} + \left\{ \frac{\pi}{2j} [\delta(\omega - 1) - \delta(\omega + 1)] + \frac{1}{1 - \omega^2} \right\} e^{-j\pi\omega/2}
 \end{aligned}$$

Also because  $f(x)\delta(x - x_0) = f(x_0)\delta(x - x_0)$ ,

$$\delta(\omega \pm 1)e^{-j\pi\omega/2} = \delta(\omega \pm 1)e^{\pm j\pi/2} = \pm j\delta(\omega \pm 1)$$

Therefore

$$F(\omega) = \frac{j\omega}{1 - \omega^2} + \frac{e^{-j\pi\omega/2}}{1 - \omega^2} = \frac{1}{1 - \omega^2} [j\omega + e^{-j\pi\omega/2}]$$

(d)

$$\begin{aligned}
 f(t) &= e^{-at} [u(t) - u(t - T)] = e^{-at} u(t) - e^{-at} u(t - T) \\
 &= e^{-at} u(t) - e^{-aT} e^{-a(t-T)} u(t - T) \\
 F(\omega) &= \frac{1}{j\omega + a} - \frac{e^{-aT}}{j\omega + a} e^{-j\omega T} = \frac{1}{j\omega + a} [1 - e^{-(a+j\omega)T}]
 \end{aligned}$$

#### 7.4-4 From time-shifting property

$$f(t \pm T) \longleftrightarrow F(\omega)e^{\pm j\omega T}$$

Therefore

$$f(t + T) + f(t - T) \longleftrightarrow F(\omega)e^{j\omega T} + F(\omega)e^{-j\omega T} = 2F(\omega) \cos \omega T$$

We can use this result to derive transforms of signals in Fig. P7.4-4.

(a) Here  $f(t)$  is a gate pulse as shown in Fig. S7.4-4a.

$$f(t) = \text{rect}\left(\frac{t}{2}\right) \iff 2 \text{sinc}(\omega)$$

Also  $T = 3$ . The signal in Fig. P7.4-4a is  $f(t+3) + f(t-3)$ , and

$$f(t+3) + f(t-3) \iff 4 \text{sinc}(\omega) \cos 3\omega$$

(b) Here  $f(t)$  is a triangular pulse shown in Fig. S7.4-4b. From the Table 7.1 (pair 19)

$$f(t) = \Delta\left(\frac{t}{2}\right) \iff \text{sinc}^2\left(\frac{\omega}{2}\right)$$

Also  $T = 3$ . The signal in Fig. P7.4-4b is  $f(t+3) + f(t-3)$ , and

$$f(t+3) + f(t-3) \iff 2 \text{sinc}^2\left(\frac{\omega}{2}\right) \cos 3\omega$$



Fig. S7.4-4

7.4-5 Frequency-shifting property states that

$$f(t)e^{\pm j\omega_0 t} \iff F(\omega \mp \omega_0)$$

Therefore

$$f(t) \sin \omega_0 t = \frac{1}{2j} [f(t)e^{j\omega_0 t} + f(t)e^{-j\omega_0 t}] = \frac{1}{2j} [F(\omega - \omega_0) + F(\omega + \omega_0)]$$

Time-shifting property states that

$$f(t \pm T) \iff F(\omega)e^{\pm j\omega T}$$

Therefore

$$f(t+T) - f(t-T) \iff F(\omega)e^{j\omega T} - F(\omega)e^{-j\omega T} = 2jF(\omega) \sin \omega T$$

and

$$\frac{1}{2j} [f(t+T) - f(t-T)] \iff F(\omega) \sin T\omega$$

The signal in Fig. P7.4-5 is  $f(t+3) - f(t-3)$  where

$$f(t) = \text{rect}\left(\frac{t}{2}\right) \iff 2 \text{sinc}(\omega)$$

Therefore

$$f(t+3) - f(t-3) \iff 2j[2 \text{sinc}(\omega) \cos 3\omega] = 4j \text{sinc}(\omega) \cos 3\omega$$

7.4-6 Fig. (a) The signal  $f(t)$  in this case is a triangle pulse  $\Delta\left(\frac{t}{2\pi}\right)$  (Fig. S7.4-6) multiplied by  $\cos 10t$ .

$$f(t) = \Delta\left(\frac{t}{2\pi}\right) \cos 10t$$

Also from Table 7.1 (pair 19)  $\Delta\left(\frac{t}{2\pi}\right) \iff \pi \text{sinc}^2\left(\frac{\omega}{2}\right)$ . From the modulation property (7.41), it follows that

$$f(t) = \Delta\left(\frac{t}{2\pi}\right) \cos 10t \iff \pi \left\{ \text{sinc}^2\left[\frac{\pi(\omega - 10)}{2}\right] + \text{sinc}^2\left[\frac{\pi(\omega + 10)}{2}\right] \right\}$$

The Fourier transform in this case is a real function and we need only the amplitude spectrum in this case as shown in Fig. S7.4-6a.

Fig. (b) The signal  $f(t)$  here is the same as the signal in Fig. (a) delayed by  $2\pi$ . From time shifting property, its Fourier transform is the same as in part (a) multiplied by  $e^{-j\omega(2\pi)}$ . Therefore

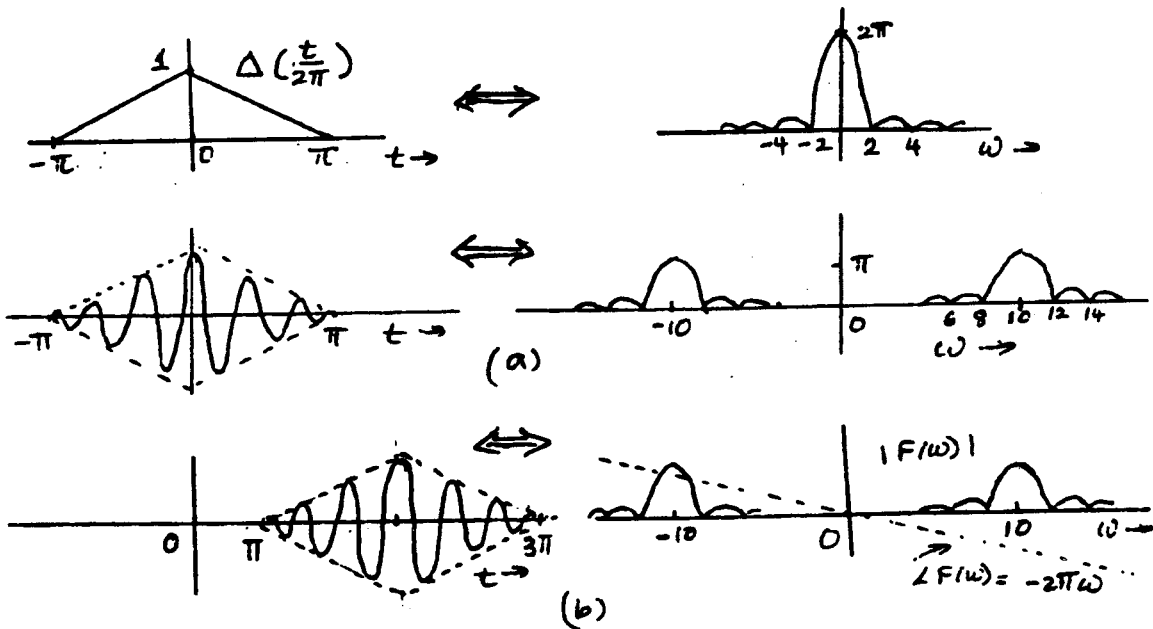

Fig. S7.4-6

$$F(\omega) = \pi \left\{ \text{sinc}^2 \left[ \frac{\pi(\omega - 10)}{2} \right] + \text{sinc}^2 \left[ \frac{\pi(\omega + 10)}{2} \right] \right\} e^{-j2\pi\omega}$$

The Fourier transform in this case is the same as that in part (a) multiplied by  $e^{-j2\pi\omega}$ . This multiplying factor represents a linear phase spectrum  $-2\pi\omega$ . Thus we have an amplitude spectrum [same as in part (a)] as well as a linear phase spectrum  $\angle F(\omega) = -2\pi\omega$  as shown in Fig. S7.4-6b. the amplitude spectrum in this case as shown in Fig. S7.4-6b.

Note: In the above solution, we first multiplied the triangle pulse  $\Delta(\frac{t}{2\pi})$  by  $\cos 10t$  and then delayed the result by  $2\pi$ . This means the signal in Fig. (b) is expressed as  $\Delta(\frac{t-2\pi}{2\pi}) \cos 10(t-2\pi)$ .

We could have interchanged the operation in this particular case, that is, the triangle pulse  $\Delta(\frac{t}{2\pi})$  is first delayed by  $2\pi$  and then the result is multiplied by  $\cos 10t$ . In this alternate procedure, the signal in Fig. (b) is expressed as  $\Delta(\frac{t-2\pi}{2\pi}) \cos 10t$ .

This interchange of operation is permissible here only because the sinusoid  $\cos 10t$  executes integral number of cycles in the interval  $2\pi$ . Because of this both the expressions are equivalent since  $\cos 10(t-2\pi) = \cos 10t$ .

Fig. (c) In this case the signal is identical to that in Fig. b, except that the basic pulse is  $\text{rect}(\frac{t}{2\pi})$  instead of a triangle pulse  $\Delta(\frac{t}{2\pi})$ . Now

$$\text{rect} \left( \frac{t}{2\pi} \right) \iff 2\pi \text{sinc}(\pi\omega)$$

Using the same argument as for part (b), we obtain

$$F(\omega) = \pi \{ \text{sinc}[\pi(\omega + 10)] + \text{sinc}[\pi(\omega - 10)] \} e^{-j2\pi\omega}$$

7.4-7 (a)

$$F(\omega) = \text{rect} \left( \frac{\omega - 4}{2} \right) + \text{rect} \left( \frac{\omega + 4}{2} \right)$$

Also

$$\frac{1}{\pi} \text{sinc}(t) \iff \text{rect} \left( \frac{\omega}{2} \right)$$

Therefore

$$f(t) = \frac{2}{\pi} \text{sinc}(t) \cos 4t$$

(b)

$$F(\omega) = \Delta \left( \frac{\omega + 4}{4} \right) + \Delta \left( \frac{\omega - 4}{4} \right)$$

Also

$$\frac{1}{\pi} \text{sinc}^2(t) \iff \Delta\left(\frac{\omega}{4}\right)$$

Therefore

$$f(t) = \frac{2}{\pi} \text{sinc}^2(t) \cos 4t$$

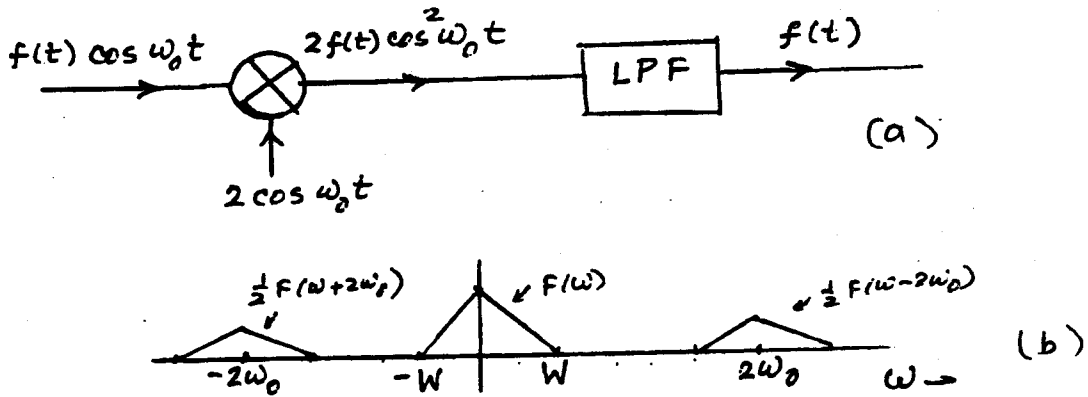

Fig. S7.4-8

7.4-8 A basic demodulator is shown in Fig. S7.4-8a. The product of the modulated signal  $f(t) \cos \omega_0 t$  with  $2 \cos \omega_0 t$  yields

$$(f(t) \cos \omega_0 t)(2 \cos \omega_0 t) = 2f(t) \cos^2 \omega_0 t = f(t)[1 + \cos 2\omega_0 t] = f(t) + f(t) \cos 2\omega_0 t$$

The product contains the desired  $f(t)$  (whose spectrum is centered at  $\omega = 0$ ) and the unwanted signal  $f(t) \cos 2\omega_0 t$  with spectrum  $\frac{1}{2}[F(\omega + 2\omega_0) + F(\omega - 2\omega_0)]$ , which is centered at  $\pm 2\omega_0$ . The two spectra are nonoverlapping because  $W < \omega_0$  (See Fig. S7.4-8b). We can suppress the unwanted signal by passing the product through a lowpass filter as shown in Fig. S7.4-8a.

7.4-9 (a)

$$e^{\lambda t} u(t) \iff \frac{1}{j\omega - \lambda} \quad \text{and} \quad u(t) \iff \pi \delta(\omega) + \frac{1}{j\omega}$$

If  $f(t) = e^{\lambda t} u(t) * u(t)$ , then

$$\begin{aligned} F(\omega) &= \left( \frac{1}{j\omega - \lambda} \right) \left( \pi \delta(\omega) + \frac{1}{j\omega} \right) \\ &= \frac{\pi \delta(\omega)}{j\omega - \lambda} + \left[ \frac{1}{j\omega(j\omega - \lambda)} \right] \\ &= -\frac{\pi}{\lambda} \delta(\omega) + \left[ \frac{-\frac{1}{\lambda}}{j\omega} + \frac{\frac{1}{\lambda}}{j\omega - \lambda} \right] \quad \text{because } f(x)\delta(x) = f(0)\delta(x) \\ &= \frac{1}{\lambda} \left[ \frac{1}{j\omega - \lambda} - \left( \pi \delta(\omega) + \frac{1}{j\omega} \right) \right] \end{aligned}$$

Taking the inverse transform of this equation yields

$$f(t) = \frac{1}{\lambda} (e^{\lambda t} - 1) u(t)$$

(b)

$$e^{\lambda_1 t} u(t) \iff \frac{1}{j\omega - \lambda_1} \quad \text{and} \quad e^{\lambda_2 t} u(t) \iff \frac{1}{j\omega - \lambda_2}$$

If  $f(t) = e^{\lambda_1 t} u(t) * e^{\lambda_2 t} u(t)$ , then

$$F(\omega) = \frac{1}{(j\omega - \lambda_1)(j\omega - \lambda_2)} = \frac{\frac{1}{\lambda_1 - \lambda_2}}{j\omega - \lambda_1} - \frac{\frac{1}{\lambda_1 - \lambda_2}}{j\omega - \lambda_2}$$

Therefore

$$f(t) = \frac{1}{\lambda_1 - \lambda_2} (e^{\lambda_1 t} - e^{\lambda_2 t}) u(t)$$

(c)

$$e^{\lambda_1 t} u(t) \iff \frac{1}{j\omega - \lambda_1} \quad \text{and} \quad e^{\lambda_2 t} u(-t) \iff -\frac{1}{j\omega - \lambda_2}$$

If  $f(t) = e^{\lambda_1 t} u(t) * e^{\lambda_2 t} u(-t)$ , then

$$F(\omega) = \frac{-1}{(j\omega - \lambda_1)(j\omega - \lambda_2)} = \frac{\frac{1}{\lambda_2 - \lambda_1}}{j\omega - \lambda_1} - \frac{\frac{1}{\lambda_2 - \lambda_1}}{j\omega - \lambda_2}$$

Therefore

$$f(t) = \frac{1}{\lambda_2 - \lambda_1} [e^{\lambda_1 t} u(t) + e^{\lambda_2 t} u(-t)]$$

Note that because  $\lambda_2 > 0$ , the inverse transform of  $\frac{-1}{j\omega - \lambda_2}$  is  $e^{\lambda_2 t} u(-t)$  and not  $-e^{\lambda_2 t} u(t)$ . The Fourier transform of the latter does not exist because  $\lambda_2 > 0$ .

(d)

$$e^{\lambda_1 t} u(-t) \iff -\frac{1}{j\omega - \lambda_1} \quad \text{and} \quad e^{\lambda_2 t} u(-t) \iff -\frac{1}{j\omega - \lambda_2}$$

If  $f(t) = e^{\lambda_1 t} u(-t) * e^{\lambda_2 t} u(-t)$ , then

$$F(\omega) = \frac{1}{(j\omega - \lambda_1)(j\omega - \lambda_2)} = \frac{\frac{-1}{\lambda_2 - \lambda_1}}{j\omega - \lambda_1} - \frac{\frac{-1}{\lambda_2 - \lambda_1}}{j\omega - \lambda_2}$$

Therefore

$$f(t) = \frac{1}{\lambda_2 - \lambda_1} (e^{\lambda_1 t} - e^{\lambda_2 t}) u(-t)$$

The remarks at the end of part (c) apply here also.

7.4-10

$$f^2(t) = \frac{1}{2\pi} F(\omega) * F(\omega)$$

Because of the width property of the convolution, the width of  $F(\omega) * F(\omega)$  is twice the width of  $F(\omega)$ . Repeated application of this argument shows that the bandwidth of  $f^n(t)$  is  $nB$  Hz ( $n$  times the bandwidth of  $f(t)$ ).

7.4-11 (a)

$$F(\omega) = \int_{-T}^0 e^{-j\omega t} dt - \int_0^T e^{-j\omega t} dt = -\frac{2}{j\omega} [1 - \cos \omega T] = \frac{j4}{\omega} \sin^2 \left( \frac{\omega T}{2} \right)$$

(b)

$$f(t) = \text{rect} \left( \frac{t + T/2}{T} \right) - \text{rect} \left( \frac{t - T/2}{T} \right)$$

$$\text{rect} \left( \frac{t}{T} \right) \iff T \text{sinc} \left( \frac{\omega T}{2} \right)$$

$$\text{rect} \left( \frac{t \pm T/2}{T} \right) \iff T \text{sinc} \left( \frac{\omega T}{2} \right) e^{\pm j\omega T/2}$$

and

$$\begin{aligned} F(\omega) &= T \text{sinc} \left( \frac{\omega T}{2} \right) [e^{j\omega T/2} - e^{-j\omega T/2}] \\ &= 2jT \text{sinc} \left( \frac{\omega T}{2} \right) \sin \frac{\omega T}{2} \\ &= \frac{j4}{\omega} \sin^2 \left( \frac{\omega T}{2} \right) \end{aligned}$$

(c)

$$\frac{df}{dt} = \delta(t + T) - 2\delta(t) + \delta(t - T)$$

The Fourier transform of this equation yields

$$j\omega F(\omega) = e^{j\omega T} - 2 + e^{-j\omega T} = -2[1 - \cos \omega T] = -4 \sin^2 \left( \frac{\omega T}{2} \right)$$

Therefore

$$F(\omega) = \frac{j^4}{\omega} \sin^2 \left( \frac{\omega T}{2} \right)$$

7.4-12

$$F(\omega) = \int_{-\infty}^{\infty} f(t)e^{-j\omega t} dt \quad \text{and} \quad \frac{dF}{d\omega} = \frac{d}{d\omega} \int_{-\infty}^{\infty} f(t)e^{-j\omega t} dt$$

Changing the order of differentiation and integration yields

$$\frac{dF}{d\omega} = \int_{-\infty}^{\infty} \frac{d}{d\omega} (f(t)e^{-j\omega t}) = \int_{-\infty}^{\infty} [-jtf(t)]e^{-j\omega t} dt$$

Therefore

$$-jtf(t) \iff \frac{dF}{d\omega}$$

(b)

$$e^{-at}u(t) \iff \frac{1}{j\omega + a}$$
$$-jte^{-at}u(t) \iff \frac{d}{d\omega} \left( \frac{1}{j\omega + a} \right) = \frac{-j}{(j\omega + a)^2}$$

and

$$te^{-at}u(t) \iff \frac{1}{(j\omega + a)^2}$$

7.5-1

$$H(\omega) = \frac{j\omega + 3}{(j\omega)^2 + 3j\omega + 2} = \frac{j\omega + 3}{(j\omega + 1)(j\omega + 2)}$$
$$Y(\omega) = F(\omega)H(\omega)$$

(a)

$$F(\omega) = \frac{1}{j\omega + 3}$$
$$Y(\omega) = \frac{1}{j\omega + 3} \left[ \frac{j\omega + 3}{(j\omega + 1)(j\omega + 2)} \right] = \frac{1}{(j\omega + 1)(j\omega + 2)} = \frac{1}{j\omega + 1} - \frac{1}{j\omega + 2}$$

Therefore

$$y(t) = (e^{-t} - e^{-2t})u(t)$$

(b)

$$F(\omega) = \frac{1}{j\omega + 4}$$
$$Y(\omega) = \frac{j\omega + 3}{(j\omega + 1)(j\omega + 2)(j\omega + 4)} = \frac{2/3}{j\omega + 1} - \frac{1/2}{j\omega + 2} - \frac{1/6}{j\omega + 4}$$
$$y(t) = \left( \frac{2}{3}e^{-t} - \frac{1}{2}e^{-2t} - \frac{1}{6}e^{-4t} \right) u(t)$$

(c)

$$F(\omega) = \frac{1}{j\omega + 2}$$
$$Y(\omega) = \frac{j\omega + 3}{(j\omega + 1)(j\omega + 2)^2} = \frac{2}{j\omega + 1} - \frac{2}{j\omega + 2} - \frac{1}{(j\omega + 2)^2}$$
$$y(t) = (2e^{-t} - 2e^{-2t} - te^{-2t})u(t)$$

(d)

$$F(\omega) = -\frac{1}{j\omega - 1}$$

$$Y(\omega) = \frac{-(j\omega + 3)}{(j\omega + 1)(j\omega + 2)(j\omega - 1)} = \frac{1}{j\omega + 1} - \frac{1/3}{j\omega + 2} - \frac{2/3}{j\omega - 1}$$

$$y(t) = (e^{-t} - \frac{1}{3}e^{-2t})u(t) + \frac{2}{3}e^t u(-t)$$

(e)

$$F(\omega) = \pi\delta(\omega) + \frac{1}{j\omega}$$

$$Y(\omega) = \frac{j\omega + 3}{(j\omega + 1)(j\omega + 2)} \left[ \pi\delta(\omega) + \frac{1}{j\omega} \right]$$

Because  $f(x)\delta(x) = f(0)\delta(x)$ , we have

$$Y(\omega) = \frac{3}{2}\pi\delta(\omega) + \frac{j\omega + 3}{j\omega(j\omega + 1)(j\omega + 2)} = \frac{3}{2}\pi\delta(\omega) + \frac{3/2}{j\omega} - \frac{2}{j\omega + 1} + \frac{1/2}{j\omega + 2}$$

$$y(t) = (\frac{3}{2} - 2e^{-t} + \frac{1}{2}e^{-2t})u(t)$$

7.5-2 (a)

$$F(\omega) = \frac{1}{j\omega + 1}$$

$$Y(\omega) = \frac{-(j\omega + 2)}{(j\omega + 1)(j\omega - 2)(j\omega + 3)} = \frac{1/6}{j\omega + 1} + \frac{1/10}{j\omega + 3} - \frac{4/15}{j\omega - 2}$$

$$y(t) = (\frac{1}{6} + \frac{1}{10}e^{-3t})u(t) + \frac{4}{15}e^{2t}u(-t)$$

(b)

$$F(\omega) = -\frac{1}{j\omega - 1}$$

$$Y(\omega) = \frac{(j\omega + 2)}{(j\omega - 1)(j\omega - 2)(j\omega + 3)} = \frac{-1/20}{j\omega + 3} - \frac{3/4}{j\omega - 1} + \frac{4/5}{j\omega - 2}$$

$$y(t) = -\frac{1}{20}e^{-3t}u(t) + (\frac{3}{4}e^t - \frac{4}{5}e^{2t})u(-t)$$

(c)

$$F(\omega) = -\frac{1}{j\omega - 2}$$

$$Y(\omega) = \frac{(j\omega + 2)}{(j\omega - 2)^2(j\omega + 3)} = \frac{1/25}{j\omega - 2} + \frac{4/5}{(j\omega - 2)^2} - \frac{1/25}{j\omega + 3}$$

$$y(t) = -\frac{1}{25}e^{-3t}u(t) + (\frac{1}{25} + \frac{4t}{5})e^{2t}u(-t)$$

(d)

$$F(\omega) = -\frac{1}{j\omega + 3}$$

$$Y(\omega) = \frac{-(j\omega + 2)}{(j\omega + 3)^2(j\omega - 2)} = \frac{4/25}{j\omega + 3} - \frac{1/5}{(j\omega + 3)^2} - \frac{4/25}{j\omega - 2}$$

$$y(t) = (\frac{4}{25} - \frac{t}{5})e^{-3t}u(t) + \frac{4}{25}e^{2t}u(-t)$$

$$H(\omega) = \frac{1}{j\omega + 1}$$

(a)

$$F(\omega) = \frac{1}{j\omega + 2}$$

$$Y(\omega) = \frac{1}{(j\omega + 1)(j\omega + 2)} = \frac{1}{j\omega + 1} - \frac{1}{j\omega + 2}$$

$$y(t) = (e^{-t} - e^{-2t})u(t)$$

(b)

$$F(\omega) = \frac{1}{j\omega + 1}$$

$$Y(\omega) = \frac{1}{(j\omega + 1)^2}$$

$$y(t) = te^{-at}u(t)$$

(c)

$$F(\omega) = -\frac{1}{j\omega - 1}$$

$$Y(\omega) = \frac{-1}{(j\omega + 1)(j\omega - 1)} = \frac{1/2}{j\omega + 1} - \frac{1/2}{j\omega - 1}$$

$$y(t) = \frac{1}{2}e^{-t}u(t) + \frac{1}{2}e^t u(-t)$$

(d)

$$F(\omega) = \pi\delta(\omega) + \frac{1}{j\omega}$$

$$Y(\omega) = \frac{1}{j\omega + 1} \left[ \pi\delta(\omega) + \frac{1}{j\omega} \right]$$

$$= \pi\delta(\omega) + \frac{1}{j\omega(j\omega + 1)} \quad [\text{because } f(x)\delta(x) = f(0)\delta(x)]$$

$$= \pi\delta(\omega) + \frac{1}{j\omega} - \frac{1}{j\omega + 1}$$

$$y(t) = (1 - e^{-t})u(t)$$

7.7-1

$$H(\omega) = e^{-k\omega^2} e^{-j\omega t_0}$$

Using pair 22 (Table 7.1) and time-shifting property, we get

$$h(t) = \frac{1}{\sqrt{4\pi k}} e^{-(t-t_0)^2/4k}$$

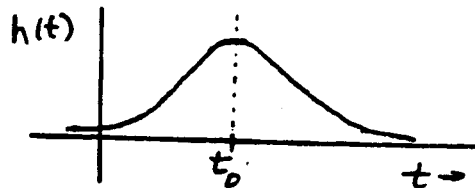

Figure S7.7-1



This is noncausal. Hence the filter is unrealizable. Also

$$\int_{-\infty}^{\infty} \frac{|\ln |H(\omega)||}{\omega^2 + 1} d\omega = \int_{-\infty}^{\infty} \frac{k\omega^2}{\omega^2 + 1} d\omega = \infty$$

Hence the filter is noncausal and therefore unrealizable. Since  $h(t)$  is a Gaussian function delayed by  $t_0$ , it looks as shown in the adjacent figure. Choosing  $t_0 = 3\sqrt{2k}$ ,  $h(0) = e^{-4.5} = 0.011$  or 1.1% of its peak value. Hence  $t_0 = 3\sqrt{2k}$  is a reasonable choice to make the filter approximately realizable.

7.7-2

$$H(\omega) = \frac{2 \times 10^8}{\omega^2 + 10^{10}} e^{-j\omega t_0}$$

From pair 3, Table 7.1 and time-shifting property, we get

$$h(t) = e^{-10^5 |t - t_0|}$$

The impulse response is noncausal, and the filter is unrealizable.

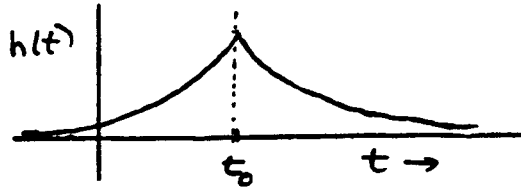

Figure S7.7-2

The exponential decays to 1.8% at 4 times constants. Hence  $t_0 = 4/a = 4 \times 10^{-5} = 40 \mu s$  is a reasonable choice to make this filter approximately realizable.

7.9-1

$$E_f = \int_{-\infty}^{\infty} f^2(t) dt = \frac{1}{2\pi\sigma^2} \int_{-\infty}^{\infty} e^{-t^2/\sigma^2} dt$$

Letting  $\frac{t}{\sigma} = \frac{x}{\sqrt{2}}$  and consequently  $dt = \frac{\sigma}{\sqrt{2}} dx$

$$E_f = \frac{1}{2\pi\sigma^2} \frac{\sigma}{\sqrt{2}} \int_{-\infty}^{\infty} e^{-x^2/2} dx = \frac{\sqrt{2\pi}}{2\sqrt{2}\pi\sigma} = \frac{1}{2\sigma\sqrt{\pi}}$$

Also from pair 22 (Table 7.1)

$$F(\omega) = e^{-\sigma^2\omega^2/2}$$

$$E_f = \frac{1}{2\pi} \int_{-\infty}^{\infty} |F(\omega)|^2 d\omega = \frac{1}{2\pi} \int_{-\infty}^{\infty} e^{-\sigma^2\omega^2} d\omega$$

Letting  $\sigma\omega = \frac{x}{\sqrt{2}}$  and consequently  $d\omega = \frac{1}{\sigma\sqrt{2}} dx$

$$E_f = \frac{1}{2\pi} \frac{1}{\sigma\sqrt{2}} \int_{-\infty}^{\infty} e^{-x^2/2} dx = \frac{\sqrt{2\pi}}{2\pi\sigma\sqrt{2}} = \frac{1}{2\sigma\sqrt{\pi}}$$

7.9-2 Consider a signal

$$f(t) = \text{sinc}(kt) \quad \text{and} \quad F(\omega) = \frac{\pi}{k} \text{rect}\left(\frac{\omega}{2k}\right)$$

$$\begin{aligned} E_f &= \int_{-\infty}^{\infty} \text{sinc}^2(kt) dt = \frac{1}{2\pi} \int_{-\infty}^{\infty} \frac{\pi^2}{k^2} \left[ \text{rect}\left(\frac{\omega}{2k}\right) \right]^2 d\omega \\ &= \frac{\pi}{2k^2} \int_{-k}^k d\omega = \frac{\pi}{k} \end{aligned}$$

7.9-3 Recall that

$$f_2(t) = \frac{1}{2\pi} \int_{-\infty}^{\infty} F_2(\omega) e^{j\omega t} d\omega \quad \text{and} \quad \int_{-\infty}^{\infty} f_1(t) e^{j\omega t} dt = F_1(-\omega)$$

Therefore

$$\begin{aligned} \int_{-\infty}^{\infty} f_1(t)f_2(t) dt &= \frac{1}{2\pi} \int_{-\infty}^{\infty} f_1(t) \left[ \int_{-\infty}^{\infty} F_2(\omega)e^{j\omega t} d\omega \right] dt \\ &= \frac{1}{2\pi} \int_{-\infty}^{\infty} F_2(\omega) \left[ \int_{-\infty}^{\infty} f_1(t)e^{j\omega t} dt \right] d\omega = \frac{1}{2\pi} \int F_1(-\omega)F_2(\omega) d\omega \end{aligned}$$

Interchanging the roles of  $f_1(t)$  and  $f_2(t)$  in the above development, we can show that

$$\int_{-\infty}^{\infty} f_1(t)f_2(t) dt = \frac{1}{2\pi} \int_{-\infty}^{\infty} F_1(\omega)F_2(-\omega) d\omega$$

7.9-4 Application of duality property [Eq. (7.31)] to pair 3 (Table 7.1) yields

$$\frac{2a}{t^2 + a^2} \longleftrightarrow 2\pi e^{-a|\omega|}$$

The signal energy is given by

$$E_f = \frac{1}{\pi} \int_0^{\infty} |2\pi e^{-a\omega}|^2 d\omega = 4\pi \int_0^{\infty} e^{-2a\omega} d\omega = \frac{2\pi}{a}$$

The energy contained within the band (0 to  $W$ ) is

$$E_W = 4\pi \int_0^W e^{-2a\omega} d\omega = \frac{2\pi}{a} [1 - e^{-2aW}]$$

If  $E_W = 0.99E_f$ , then

$$e^{-2aW} = 0.01 \implies W = \frac{2.3025}{a} \text{ rad/s} = \frac{0.366}{a} \text{ Hz}$$

7.9-5 (a)

$$\begin{aligned} E_g &= \int_{-\infty}^{\infty} [f_1(t) + f_2(t)]^2 dt = \int_{-\infty}^{\infty} f_1^2(t) dt + \int_{-\infty}^{\infty} f_2^2(t) dt + 2 \int_{-\infty}^{\infty} f_1(t)f_2(t) dt \\ &= E_{f_1} + E_{f_2} + 2 \int_{-\infty}^{\infty} f_1(t)f_2(t) dt \end{aligned}$$

(b) If  $f_1(t)$  and  $f_2(t)$  are orthogonal we have

$$E_g = E_{f_1} + E_{f_2}$$

Moreover using the argument in part a, we can show that

$$E_s = E_{f_1} + E_{f_2} - 2 \int_{-\infty}^{\infty} f_1(t)f_2(t) dt$$

If  $f_1(t)$  and  $f_2(t)$  are orthogonal

$$E_s = E_{f_1} + E_{f_2}$$

(c) We can readily extend this argument to show that if  $w(t) = a_1 f_1(t) \pm a_2 f_2(t)$  and if  $f_1(t)$  and  $f_2(t)$  are orthogonal, then

$$E_w = a_1^2 E_{f_1} + a_2^2 E_{f_2}$$

# Chapter 8

8.1-1 The bandwidths of  $f_1(t)$  and  $f_2(t)$  are 100 kHz and 150 kHz, respectively. Therefore the Nyquist sampling rates for  $f_1(t)$  is 200 kHz and for  $f_2(t)$  is 300 kHz.

Also  $f_1^2(t) \iff \frac{1}{2\pi} F_1(\omega) * F_1(\omega)$ , and from the width property of convolution the bandwidth of  $f_1^2(t)$  is twice the bandwidth of  $f_1(t)$  and that of  $f_2^3(t)$  is three times the bandwidth of  $f_2(t)$  (see also Prob. 7.4-10). Similarly the bandwidth of  $f_1(t)f_2(t)$  is the sum of the bandwidth of  $f_1(t)$  and  $f_2(t)$ . Therefore the Nyquist rate for  $f_1^2(t)$  is 400 kHz, for  $f_2^3(t)$  is 900 kHz, for  $f_1(t)f_2(t)$  is 500 kHz.

8.1-2 (a)

$$\text{sinc}^2(100\pi t) \iff 0.01 \Delta\left(\frac{\omega}{400\pi}\right)$$

The bandwidth of this signal is  $200\pi$  rad/s or 100 Hz. The Nyquist rate is 200 Hz (samples/sec)

(b)

$$\text{sinc}(100\pi t) + 3 \text{sinc}^2(60\pi t) \iff 0.01 \text{rect}\left(\frac{\omega}{300\pi}\right) + \frac{1}{20} \Delta\left(\frac{\omega}{240\pi}\right)$$

The bandwidth of  $\text{rect}\left(\frac{\omega}{300\pi}\right)$  is 50 Hz and that of  $\Delta\left(\frac{\omega}{240\pi}\right)$  is 60 Hz. The bandwidth of the sum is the higher of the two, that is, 60 Hz. The Nyquist sampling rate is 120 Hz.

(c)

$$\begin{aligned} \text{sinc}(50\pi t) &\iff 0.02 \text{rect}\left(\frac{\omega}{200\pi}\right) \\ \text{sinc}(100\pi t) &\iff 0.01 \text{rect}\left(\frac{\omega}{400\pi}\right) \end{aligned}$$

The two signals have bandwidths 25 Hz and 50 Hz respectively. The spectrum of the product of two signals is  $1/2\pi$  times the convolution of their spectra. From width property of the convolution, the width of the convoluted signal is the sum of the widths of the signals convolved. Therefore, the bandwidth of  $\text{sinc}(50\pi t)\text{sinc}(100\pi t)$  is  $25 + 50 = 75$  Hz. The Nyquist rate is 150 Hz.

8.1-3 Assume a signal  $f(t)$  that is simultaneously timelimited and bandlimited. Let  $F(\omega) = 0$  for  $|\omega| > 2\pi B$ . Therefore  $F(\omega)\text{rect}\left(\frac{\omega}{4\pi B'}\right) = F(\omega)$  for  $B' > B$ . Therefore from the time-convolution property (7.42)

$$\begin{aligned} f(t) &= f(t) * [2B' \text{sinc}(2\pi B't)] \\ &= 2B' f(t) * \text{sinc}(2\pi B't) \end{aligned}$$

Because  $f(t)$  is timelimited,  $f(t) = 0$  for  $|t| > T$ . But  $f(t)$  is equal to convolution of  $f(t)$  with  $\text{sinc}(2\pi B't)$  which is not timelimited. It is impossible to obtain a time-limited signal from the convolution of a time-limited signal with a non-timelimited signal.

8.1-4

$$F_1(\omega) = 10^{-4} \text{sinc}\left(\frac{\omega}{2000\pi}\right) \quad \text{and} \quad F_2(\omega) = 1$$

Figure S8.1-4 shows  $F_1(\omega)$ ,  $F_2(\omega)$ ,  $H_1(\omega)$  and  $H_2(\omega)$ . Now

$$\begin{aligned} Y_1(\omega) &= F_1(\omega)H_1(\omega) \\ Y_2(\omega) &= F_2(\omega)H_2(\omega) \end{aligned}$$

The spectra  $Y_1(\omega)$  and  $Y_2(\omega)$  are also shown in Fig. S8.1-4. The bandwidth of  $y_1(t)$  and  $y_2(t)$  are 10 kHz, 5 kHz, respectively. Therefore the bandwidth of the product  $y(t) = y_1(t)y_2(t)$  is 15 kHz (see Prob. 8.1-1) and its Nyquist rate is 30 kHz.

8.1-5 This problem is identical to example 7.18 except that the energy in the band is required to be 99% of the total signal energy (instead of 95% in the Example 7.18). Following the development in Example 7.18, we have

$$\frac{0.99\pi}{2} = \tan^{-1} \frac{W}{a} \implies W = 63.66a \text{ rad/s} = 10.13a \text{ Hz}$$

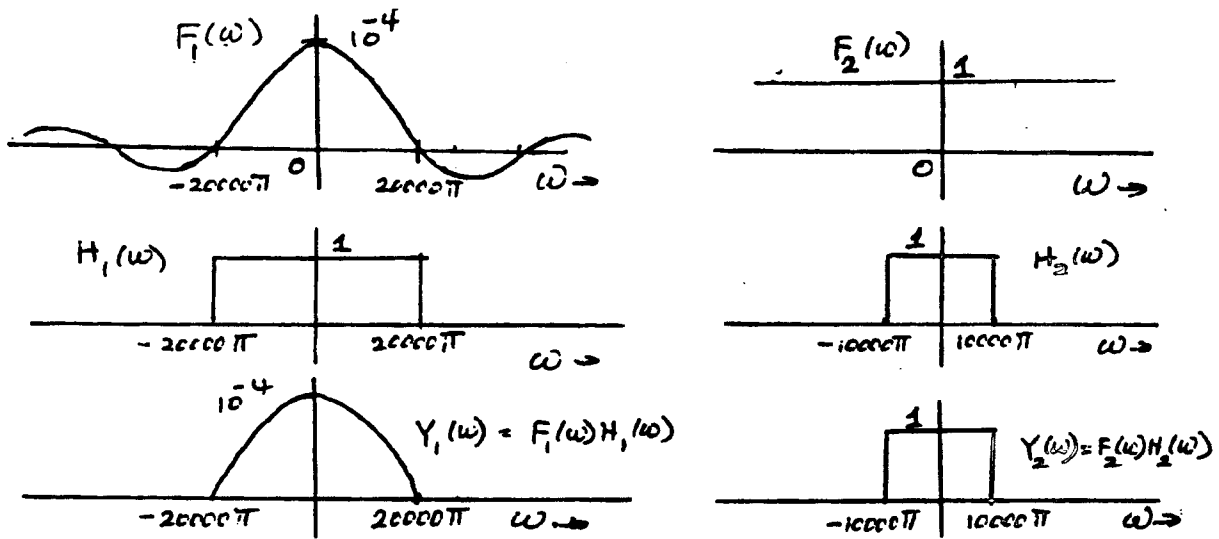

Fig. 8.1-4

The bandwidth of the anti-aliasing filter is 10.13a Hz.

8.1-6 (a) When the input is  $\delta(t)$ , the input of the integrator is  $[\delta(t) - \delta(t - T)]$ . And,  $h(t)$ , the output of the integrator is:

$$h(t) = \int_0^t [\delta(\tau) - \delta(\tau - T)] d\tau = u(t) - u(t - T) = \text{rect}\left(\frac{t - \frac{T}{2}}{T}\right)$$

The impulse response  $h(t)$  is shown in Fig. S8.1-6a.

(b) The transfer function of this circuit is:

$$H(\omega) = T \text{sinc}\left(\frac{\omega T}{2}\right) e^{-j\omega T/2}$$

and

$$|H(\omega)| = T \left| \text{sinc}\left(\frac{\omega T}{2}\right) \right|$$

The amplitude response of the filter is shown in Fig. 7.1-6b. Observe that the filter is a lowpass filter of bandwidth  $2\pi/T$  rad/s or  $1/T$  Hz.

The impulse response of the circuit is a rectangular pulse. When a sampled signal is applied at the input, each sample generates a rectangular pulse at the output, proportional to the corresponding sample value. Hence the output is a staircase approximation of the input as shown in Fig. S8.1-6c.

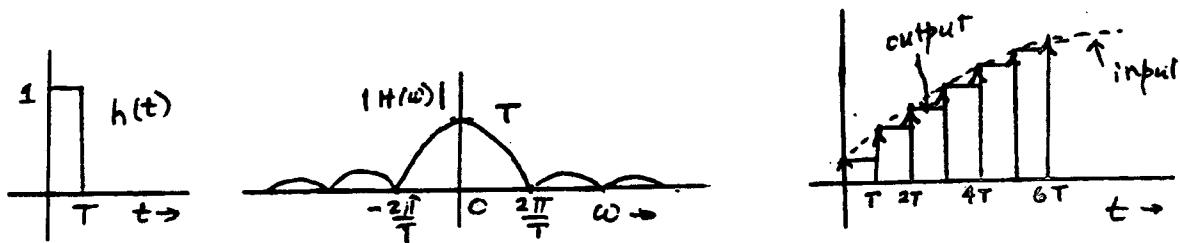

Figure S8.1-6

8.1-7

- (a) The bandwidth is 15 kHz. The Nyquist rate is 30 kHz.
- (b)  $65536 = 2^{16}$ , so that 16 binary digits are needed to encode each sample.
- (c)  $30000 \times 16 = 480000$  bits/s.
- (d)  $44100 \times 16 = 705600$  bits/s.

8.1-8

- (a) The Nyquist rate is  $2 \times 4.5 \times 10^6 = 9$  MHz. The actual sampling rate =  $1.2 \times 9 = 10.8$  MHz.

(b)  $1024 = 2^{10}$ , so that 10 bits or binary pulses are needed to encode each sample.

(c)  $10.8 \times 10^6 \times 10 = 108 \times 10^6$  or 108 Mbits/s.

8.2-1 (i) Linearity - proof is trivial

(ii) Time-shifting

$$\begin{aligned} DFT\{f_{h-n}\} &= \sum_{h=0}^{N_0-1} f_{h-n} e^{-j h (2\pi/N_0)r} \\ &= \sum_{m=-n}^{N_0-1-n} f_m e^{-j(m+n)(2\pi/N_0)r} \\ &= e^{-j(2\pi/N_0)nr} \sum_{m=-n}^{N_0-1-n} f_m e^{-j m (2\pi/N_0)r} \\ &= e^{-j n (2\pi/N_0)r} \left[ \sum_{m=-n}^{-1} f_m e^{-j m (2\pi/N_0)r} + \sum_{m=0}^{N_0-1-n} f_m e^{-j m (2\pi/N_0)r} \right] \end{aligned}$$

Because the sequence  $f_h$  is  $N_0$ -periodic, the first summation can be written as:

$$\sum_{m=N_0-n}^{N_0-1} f_{-N_0+m} e^{-j(-N_0+m)(2\pi/N_0)r} = \sum_{m=N_0-n}^{N_0-1} f_m e^{-j m (2\pi/N_0)r}$$

The two summations now combine as one summation as

$$\begin{aligned} DFT\{f_{h-n}\} &= e^{-j n (2\pi/N_0)r} \sum_{m=0}^{N_0-1} f_m e^{-j m (2\pi/N_0)r} \\ &= e^{-j n (2\pi/N_0)r} F_r \end{aligned}$$

(iii) The frequency-shifting property can be proved in a manner similar to the time-shifting property by interchanging the role of  $f_h$  and  $F_r$ .

(iv) Cyclic convolution

$$\begin{aligned} DFT\{f_h + g_h\} &= DFT \left[ \sum_{n=0}^{N_0-1} f_n g_{h-n} \right] \\ &= \sum_{n=0}^{N_0-1} f_n DFT(g_{h-n}) \\ &= \sum_{n=0}^{N_0-1} f_n e^{-j n (2\pi/N_0)r} G_r \\ &= F_r G_r \end{aligned}$$

8.2-2

$$T_0 = \frac{1}{F_c} = \frac{1}{50} = 20 \text{ms}$$

$$B = 10000 \text{ Hence } F_s \geq 2B = 20000$$

$$T = \frac{1}{F_s} = \frac{1}{20000} = 50 \mu\text{s}$$

$$N_0 = \frac{T_0}{T} = \frac{20 \times 10^{-3}}{50 \times 10^{-6}} = 400$$

Since  $N_0$  must be a power of 2, we choose  $N_0 = 512$ . Also  $T = 50 \mu\text{s}$ , and  $T_0 = N_0 T = 512 \times 50 \mu\text{s} = 25.6 \text{ms}$ ,  $F_c = 1/T_0 = 39.0625 \text{ Hz}$ . Since  $f(t)$  is of 10 ms duration, we need zero padding over 15.6 ms.

Alternatively, we could also have used

$$T = \frac{20 \times 10^{-3}}{512} = 39.0625 \mu\text{s}$$

This gives  $T_0 = 20 \text{ ms}$ ,  $\mathcal{F}_0 = 50 \text{ Hz}$ . And

$$\mathcal{F}_s = \frac{1}{T} = 25600 \text{ Hz}$$

There are also other possibilities of reducing  $T$  as well as increasing the frequency resolution.

8.3-3

$$T_0 \geq \frac{1}{0.25} = 4, \quad T \leq \frac{1}{\mathcal{F}_s} = \frac{1}{3 \times 2} = \frac{1}{6}$$

Let us choose  $T = 1/8$ ,  $T_0 = 4$ , and  $N_0 = T_0/T = 32$ . The signal  $f(t)$  repeats every 4 seconds with samples every 0.25 secs. The 32 samples as

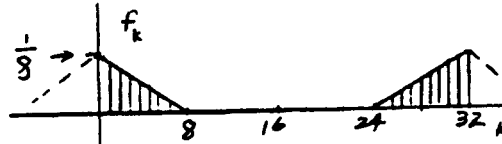

Figure S8.3-3

$$f_k = \frac{T_0}{N_0} f(kT) = \begin{cases} \frac{1}{8} \left(1 - \frac{k}{8}\right) & 0 \leq k \leq 8 \\ \frac{1}{8} \left(-3 + \frac{k}{8}\right) & 24 \leq k \leq 31 \\ 0 & 9 \leq k \leq 23 \end{cases}$$

8.3-4

$$f(t) = e^{-t} u(t) \quad F(j\omega) = \frac{1}{j\omega + 1}$$

$$|F(\omega)| = \frac{1}{\sqrt{\omega^2 + 1}} \approx \frac{1}{\omega} \quad \omega \gg 1$$

We estimated the essential bandwidth for this signal in Prob. 8.1-5 to be 10.13 Hz (using 99% energy criterion). In this case  $a = 1$ , and the essential bandwidth is 10.13 Hz. Let us use a round value of 10 Hz. The sampling frequency  $\mathcal{F}_s = 20 \text{ Hz}$ , and the sampling interval  $T = 0.05 \text{ s}$ .

The signal  $e^{-t} u(t)$  becomes negligible after, say, 6 time constant ( $e^{-6} \approx 0$ ). Thus, we have  $T_0 = 6$ ,  $T = 0.05$ ,  $N_0 = T_0/T = 120$ . Since  $N_0$  is a power of 2, choose  $N_0 = 128$ . The revised values are  $N_0 = 128$ ,  $T = 0.05$ ,  $T_0 = 128 \times 0.05 = 6.4$ . Hence  $\mathcal{F}_0 = 0.15625 \text{ Hz}$ .

8.3-5

$$f(t) = \frac{2}{t^2 + 1}$$

Application of duality property to pair 3 (Table 7.1) yields

$$\frac{2}{t^2 + 1} \iff 2\pi e^{-|\omega|}$$

This is a lowpass spectrum extending to  $\omega = \infty$ . The effective bandwidth of this signal to contain 99% of the signal energy was found in Prob. 7.9-4 to be 0.366 Hz. Therefore the sampling frequency  $\mathcal{F}_s \geq 0.732 \text{ Hz}$ , and the sampling interval  $T \leq \frac{1}{0.732} = 1.366 \text{ s}$ . We select  $T = 1$ , a round number for convenience.

$$\text{Also } f(0) = 2 \text{ and } f(t) \approx \frac{2}{t^2} \quad t \gg 1$$

Choose  $T_0$ , the duration of  $f(t)$ , that value where  $f(t)$  is 2% of  $f(0)$ .

$$f(T_0) = \frac{2}{T_0^2} = \frac{4}{100} \implies T_0 = 7.07$$

Hence

$$N_0 = \frac{T_0}{T} = \frac{7.07}{1} = 7.07$$

It is convenient to select  $N_0$  as a power of 2. We select  $N_0 = 8$ . Thus our final values are

$$T = 1, N_0 = 8, T_0 = N_0 T = 8, F_s = \frac{1}{T_0} = 0.125 \text{ Hz}$$

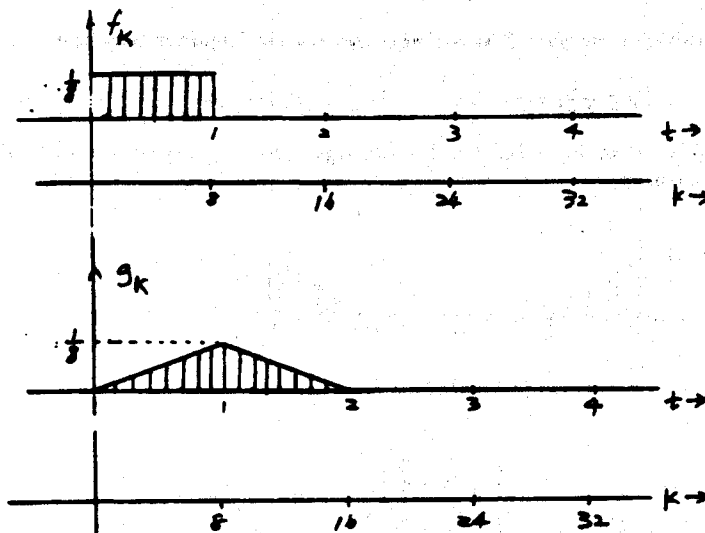

Figure S8.3-6

8.3-6 The widths of  $f(t)$  and  $g(t)$  are 1 and 2 respectively. Hence the width of the convolved signal is  $1 + 2 = 3$ . This means we need to zero-pad  $f(t)$  for 2 secs. and  $g(t)$  for 1 sec., making  $T_0 = 3$  for both signals. Since  $T = 0.125$

$$N_0 = \frac{3}{0.125} = 24$$

$N_0$  must be a power of 2. Choose  $N_0 = 32$ . This permits us to adjust  $T_0$  to 4. Hence the final values are  $T = 0.125$  and  $T_0 = 4$ . The samples of  $f(t)$  and  $g(t)$  are as shown.

Observe that  $T_0/N_0 = 1/8$ , therefore  $f_k = 1/8$ . Similarly the peak value of  $g_k = 1/8$ .

# Chapter 9

9.1-1

- (a)  $e^{j(0.2\pi k + \theta)} - j0.8\pi k = e^{j(0.2\pi k + \theta)}$
- (b)  $e^{j4\pi k - j4\pi k} = e^{j0k} = 1$
- (c)  $e^{-j1.95k + j2\pi k} = e^{j0.05k}$
- (d)  $e^{-j10.7\pi k + j12\pi k} = e^{j1.3\pi k}$

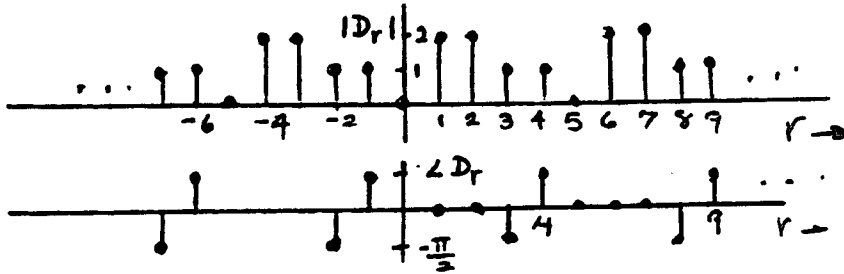

Fig. 9.1-2

9.1-2

$$\begin{aligned}
 f[k] &= 4 \cos 2.4\pi k + 2 \sin 3.2\pi k \\
 &= 4 \cos 0.4\pi k + 2 \sin 1.2\pi k \\
 &= 2[e^{j0.4\pi k} + e^{-j0.4\pi k}] + \frac{1}{j}[e^{j1.2\pi k} - e^{-j1.2\pi k}] \\
 &= 2e^{j0.4\pi k} + 2e^{-j0.4\pi k} + e^{j(1.2\pi k - \pi/2)} + e^{-j(1.2\pi k - \pi/2)}
 \end{aligned}$$

The fundamental  $\Omega_0 = 0.4\pi$  and  $N_0 = \frac{2\pi}{\Omega_0} = 5$ . Note also that.

$$e^{-j0.4\pi k} = e^{j1.6\pi k} \quad \text{and} \quad e^{-j1.2\pi k} = e^{j0.8\pi k}$$

Therefore

$$f[k] = 2e^{j0.4\pi k} + 2e^{j1.6\pi k} + e^{j(1.2\pi k - \pi/2)} + e^{j(0.8\pi k + \pi/2)}$$

We have first, second, third and fourth harmonics with coefficients

$$\begin{aligned}
 D_1 &= D_2 = 2 \quad D_3 = -j \quad D_4 = j \\
 |D_1| &= |D_2| = 2 \quad |D_3| = |D_4| = 1 \\
 \angle D_1 &= \angle D_2 = 0 \quad \angle D_3 = -\frac{\pi}{2} \quad \text{and} \quad \angle D_4 = \frac{\pi}{2}
 \end{aligned}$$

The spectrum is shown in Fig. S9.1-2.

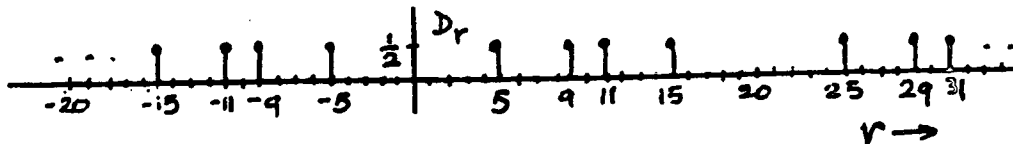

Fig. 9.1-3



9.1-3

$$\begin{aligned}
 f[k] &= \cos 2.2\pi k \cos 3.3\pi k = \frac{1}{2}[\cos 5.5\pi k + \cos 1.1\pi k] \\
 &= \frac{1}{2}[\cos 1.5\pi k + \cos 1.1\pi k] \\
 &= \frac{1}{2}[e^{j1.5\pi k} + e^{-j1.5\pi k} + e^{j1.1\pi k} + e^{-j1.1\pi k}] \\
 &= \frac{1}{2}[e^{j1.5\pi k} + e^{j0.5\pi k} + e^{j1.1\pi k} + e^{j0.9\pi k}]
 \end{aligned}$$

The fundamental frequency  $\Omega_0 = 0.1$  and  $N_0 = \frac{2\pi}{\Omega_0} = 20$ . There are only 5th, 9th, 11th and 15th harmonics with coefficients

$$D_5 = D_9 = D_{11} = D_{15} = \frac{1}{2}$$

All the form coefficients are real (phases zero). The spectrum is shown in Fig. S9.1-3.

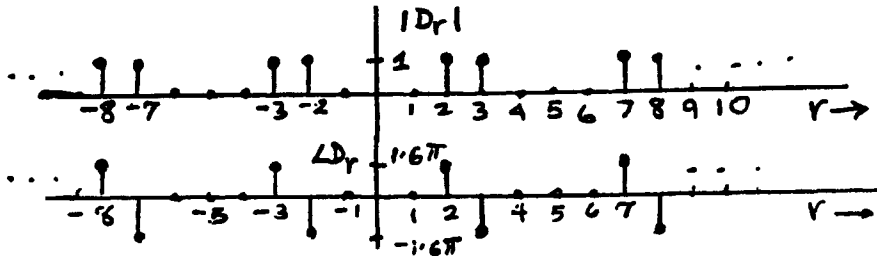

Fig. 9.1-4

9.1-4

$$\begin{aligned}
 f[k] &= 2 \cos 3.2\pi(k-3) = 2 \cos(3.2\pi k - 9.6\pi) = 2 \cos(1.2\pi k - 1.6\pi) \\
 &= e^{j(1.2\pi k - 1.6\pi)} + e^{-j(1.2\pi k - 1.6\pi)} \\
 &= e^{j(1.2\pi k - 1.6\pi)} + e^{j(0.8\pi k + 1.6\pi)}
 \end{aligned}$$

The fundamental frequency  $\Omega_0 = 0.4\pi$  and  $N_0 = \frac{2\pi}{\Omega_0} = 5$ . Only 2nd, and 3rd harmonics are present.

$$|D_2| = |D_3| = 1 \quad \angle D_2 = 9.6\pi = 1.6\pi \quad \angle D_3 = -9.6\pi = -1.6\pi$$

The spectrum is shown in Fig. S9.1-4.

9.1-5 To compute coefficients  $D_r$ , we use Eq. (9.15) where summation is performed over any interval  $N_0$ . We choose this interval to be  $-N_0/2, N_0/2$  (for even  $N_0$ ). Therefore

$$D_r = \frac{1}{N_0} \sum_{k=-N_0/2}^{N_0/2} f[k] e^{-j r \Omega_0 k}$$

In the present case  $N_0 = 6$ ,  $\Omega_0 = \frac{2\pi}{N_0} = \frac{\pi}{3}$ , and

$$D_r = \frac{1}{6} \sum_{k=-3}^3 f[k] e^{-j r \frac{\pi}{3} k}$$

We have  $f[0] = 3$ ,  $f[\pm 1] = 2$ ,  $f[\pm 2] = 1$ , and  $f[\pm 3] = 0$ . Therefore

$$\begin{aligned}
 D_r &= \frac{1}{6} [3 + 2(e^{j \frac{\pi}{3} r} + e^{-j \frac{\pi}{3} r}) + (e^{j \frac{2\pi}{3} r} + e^{-j \frac{2\pi}{3} r})] \\
 &= \frac{1}{6} [3 + 4 \cos(\frac{\pi}{3} r) + 2 \cos(\frac{2\pi}{3} r)]
 \end{aligned}$$

$$D_0 = \frac{3}{2} \quad D_1 = \frac{3}{2} \quad D_2 = 0 \quad D_3 = \frac{1}{2} \quad D_4 = 0 \quad D_5 = \frac{3}{2}$$

9.1-6 In this case  $N_0 = 12$  and  $\Omega_0 = \frac{\pi}{2}$ .

$$\begin{aligned} f[0] &= 0 & f[1] &= 1 & f[-1] &= -1 & f[2] &= 2 & f[-2] &= -2 \\ f[3] &= 3 & f[-3] &= -3 & f[\pm 4] &= f[\pm 5] &= f[\pm 6] &= 0 \end{aligned}$$

Therefore

$$\begin{aligned} D_r &= \frac{1}{12} \sum_{k=-6}^6 f[k] e^{-j\frac{\pi}{2}kr} \\ &= \frac{1}{12} [e^{-j\frac{\pi}{2}r} - e^{j\frac{\pi}{2}r} + 2(e^{-j\frac{3\pi}{2}r} - e^{j\frac{3\pi}{2}r}) + 3(e^{-j\frac{5\pi}{2}r} - e^{j\frac{5\pi}{2}r})] \\ &= \frac{-j}{12} [2 \sin(\frac{\pi}{2}r) + 4 \sin(\frac{3\pi}{2}r) + 6 \sin(\frac{5\pi}{2}r)] \end{aligned}$$

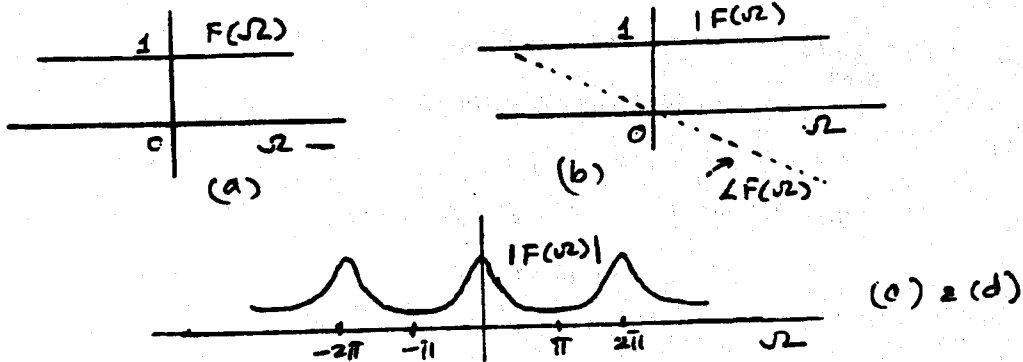

Fig. 9.2-1

9.2-1 (a)

$$F(\Omega) = \sum_{k=-\infty}^{\infty} \delta[k] e^{-j\Omega k} = 1$$

(b)

$$\begin{aligned} F(\Omega) &= \sum_{k=-\infty}^{\infty} \delta[k - k_0] e^{-j\Omega k} = e^{-j\Omega k_0} \\ |F(\Omega)| &= 1 \quad \angle F(\Omega) = -\Omega k_0 \end{aligned}$$

(c)

$$\begin{aligned} F(\Omega) &= \sum_{k=1}^{\infty} a^k e^{-j\Omega k} = \sum_{k=1}^{\infty} (ae^{-j\Omega})^k = \frac{(ae^{-j\Omega})^{\infty} - (ae^{-j\Omega})}{ae^{-j\Omega} - 1} \\ &= \frac{0 - ae^{-j\Omega}}{ae^{-j\Omega} - 1} = \frac{a}{e^{j\Omega} - a} = \frac{a}{(\cos \Omega - a) + j \sin \Omega} \\ |F(\Omega)| &= \frac{a}{\sqrt{(1+a^2) - 2a \cos \Omega}} \quad \angle F(\Omega) = -\tan^{-1} \left( \frac{\sin \Omega}{\cos \Omega - a} \right) \end{aligned}$$

(d)

$$\begin{aligned} F(\Omega) &= \sum_{k=-1}^{\infty} (ae^{-j\Omega})^k = \frac{(ae^{-j\Omega})^{\infty} - (ae^{-j\Omega})^{-1}}{ae^{-j\Omega} - 1} = \frac{e^{j2\Omega}}{a(e^{j\Omega} - a)} \\ |F(\Omega)| &= \frac{1}{a\sqrt{1+a^2 - 2a \cos \Omega}} \quad \angle F(\Omega) = 2\Omega - \tan^{-1} \left( \frac{\sin \Omega}{\cos \Omega - a} \right) \end{aligned}$$

9.2-2 (a)

$$F(\Omega) = \sum_{k=-3}^3 f[k]e^{-j\Omega k} = 3 + 2(e^{-j\Omega} + e^{j\Omega}) + (e^{-j2\Omega} + e^{j2\Omega})$$

$$= 3 + 4 \cos \Omega + 2 \cos 2\Omega$$

(b)

$$F(\Omega) = \sum_{k=0}^6 f[k]e^{-j\Omega k} = e^{-j\Omega} + 2e^{-j2\Omega} + 3e^{-j3\Omega} + 2e^{-j4\Omega} + e^{-j5\Omega}$$

$$= e^{-j3\Omega}[(e^{j2\Omega} + e^{-j2\Omega}) + 2(e^{j\Omega} + e^{-j\Omega}) + 3]$$

$$= e^{-j3\Omega}[3 + 4 \cos \Omega + 2 \cos 2\Omega]$$

(c)

$$F(\Omega) = \sum_{k=-3}^3 f[k]e^{-j\Omega k} = 3e^{-j\Omega} - 3e^{j\Omega} + 6e^{-j2\Omega} - 6e^{j2\Omega} + 9e^{-j3\Omega} - 9e^{j3\Omega}$$

$$= 6j[\sin \Omega + 2 \sin 2\Omega + 3 \sin 3\Omega]$$

(d)

$$F(\Omega) = \sum_{k=-2}^2 f[k]e^{-j\Omega k} = 2e^{-j\Omega} + 2e^{j\Omega} + 4e^{-j2\Omega} + 4e^{j2\Omega}$$

$$= 4 \cos \Omega + 8 \cos 2\Omega$$

9.2-3 (a)

$$f[k] = \frac{1}{2\pi} \int_{2\pi} F(\Omega) e^{j\Omega k} d\Omega$$

$$= \frac{1}{2\pi} \int_{-\pi/2}^{\pi/2} \Delta\left(\frac{\Omega}{\pi}\right) e^{j\Omega k} d\Omega$$

Instead of evaluating this integral directly, we evaluate it using Eq. (9.64). If  $f(t)$  is the inverse Fourier transform of  $F(\omega)$ , then the desired  $f[k]$  is  $f(t)|_{t=k}$ . Now

$$f(t) = \mathcal{F}^{-1} \left[ \Delta\left(\frac{\omega}{\pi}\right) \right] = \frac{1}{4} \text{sinc}^2\left(\frac{\pi t}{4}\right)$$

and

$$f[k] = \frac{1}{4} \text{sinc}^2\left(\frac{\pi k}{4}\right)$$

(b)

$$F(\Omega) = \text{rect}\left(\frac{\Omega}{\pi}\right) + \Delta\left(\frac{\Omega}{\pi}\right)$$

$$F(\omega) = \text{rect}\left(\frac{\omega}{\pi}\right) + \Delta\left(\frac{\omega}{\pi}\right)$$

$$f(t) = \frac{1}{2} \text{sinc}\left(\frac{\pi t}{2}\right) + \frac{1}{4} \text{sinc}^2\left(\frac{\pi t}{4}\right)$$

$$f[k] = \frac{1}{2} \text{sinc}\left(\frac{\pi k}{2}\right) + \frac{1}{4} \text{sinc}^2\left(\frac{\pi k}{4}\right)$$

(c)

$$F(\Omega) = \text{rect}\left(\frac{\Omega}{\pi}\right) - \Delta\left(\frac{\Omega}{\pi}\right)$$

$$F(\omega) = \text{rect}\left(\frac{\omega}{\pi}\right) - \Delta\left(\frac{\omega}{\pi}\right)$$

$$f(t) = \frac{1}{2} \text{sinc}\left(\frac{\pi t}{2}\right) - \frac{1}{4} \text{sinc}^2\left(\frac{\pi t}{4}\right)$$

$$f[k] = \frac{1}{2} \text{sinc}\left(\frac{\pi k}{2}\right) - \frac{1}{4} \text{sinc}^2\left(\frac{\pi k}{4}\right)$$

(d)

$$\begin{aligned}
 F(\Omega) &= \text{rect}\left(\frac{\Omega}{2\pi}\right) + \text{rect}\left(\frac{\Omega}{\pi}\right) \\
 F(\omega) &= \text{rect}\left(\frac{\omega}{2\pi}\right) + \text{rect}\left(\frac{\omega}{\pi}\right) \\
 f(t) &= \text{sinc}(\pi t) + \frac{1}{2}\text{sinc}\left(\frac{\pi t}{2}\right) \\
 f[k] &= \text{sinc}(\pi k) + \frac{1}{2}\text{sinc}\left(\frac{\pi k}{2}\right) = \delta[k] + \frac{1}{2}\text{sinc}\left(\frac{\pi k}{2}\right)
 \end{aligned}$$

9.3-1

$$\begin{aligned}
 F(\Omega) &= \frac{1}{1 + 0.5e^{-j\Omega}} = \frac{e^{j\Omega}}{e^{j\Omega} + 0.5} \\
 Y(\Omega) &= F(\Omega)H(\Omega) = \frac{e^{j\Omega}(e^{j\Omega} + 0.32)}{(e^{j\Omega} + 0.5)(e^{j\Omega} + 0.8)(e^{j\Omega} + 0.2)} \\
 \frac{Y(\Omega)}{e^{j\Omega}} &= \frac{e^{j\Omega} + 0.32}{(e^{j\Omega} + 0.5)(e^{j\Omega} + 0.8)(e^{j\Omega} + 0.2)} \\
 &= \frac{2}{e^{j\Omega} + 0.5} - \frac{8/3}{e^{j\Omega} + 0.8} + \frac{2/3}{e^{j\Omega} + 0.2} \\
 Y(\Omega) &= 2\frac{e^{j\Omega}}{e^{j\Omega} + 0.5} - \frac{8}{3}\frac{e^{j\Omega}}{e^{j\Omega} + 0.8} + \frac{2}{3}\frac{e^{j\Omega}}{e^{j\Omega} + 0.2} \\
 y[k] &= \left[2(-0.5)^k - \frac{8}{3}(-0.8)^k + \frac{2}{3}(-0.2)^k\right] u[k]
 \end{aligned}$$

9.3-2

$$\begin{aligned}
 f[k] &= \frac{1}{3}\left(\frac{1}{3}\right)^k \quad \text{and} \quad F(\Omega) = \frac{1}{3}\frac{e^{j\Omega}}{e^{j\Omega} - 1/3} \\
 Y(\Omega) &= F(\Omega)H(\Omega) = \frac{1}{3}\frac{e^{j\Omega}(e^{j\Omega} - 0.5)}{(e^{j\Omega} - 1/3)(e^{j\Omega} + 0.5)(e^{j\Omega} - 1)} \\
 \frac{Y(\Omega)}{e^{j\Omega}} &= \frac{1}{3}\frac{e^{j\Omega} - 0.5}{(e^{j\Omega} - 1/3)(e^{j\Omega} + 0.5)(e^{j\Omega} - 1)} = \frac{1}{3}\left[\frac{0.3}{e^{j\Omega} - 1/3} - \frac{0.8}{e^{j\Omega} + 0.5} + \frac{0.5}{e^{j\Omega} - 1}\right] \\
 Y(\Omega) &= \frac{1}{3}\left[0.3\frac{e^{j\Omega}}{e^{j\Omega} - 1/3} - 0.8\frac{e^{j\Omega}}{e^{j\Omega} + 0.5} + 0.5\frac{e^{j\Omega}}{e^{j\Omega} - 1}\right] \\
 y[k] &= \left[\frac{1}{10}\left(\frac{1}{3}\right)^k - \frac{4}{15}(-0.5)^k + \frac{1}{6}\right] u[k]
 \end{aligned}$$

9.3-3

$$\begin{aligned}
 F(\Omega) &= \frac{e^{j\Omega}}{e^{j\Omega} - 0.8} - \frac{2e^{j\Omega}}{e^{j\Omega} - 2} \\
 Y(\Omega) &= F(\Omega)H(\Omega) = \frac{e^{j2\Omega}}{(e^{j\Omega} - 0.5)(e^{j\Omega} - 0.8)} - \frac{2e^{j2\Omega}}{(e^{j\Omega} - 0.5)(e^{j\Omega} - 2)} \\
 &= \frac{-5/3}{e^{j\Omega} - 0.5} + \frac{8/3}{e^{j\Omega} - 0.8} + \frac{2/3}{e^{j\Omega} - 0.5} - \frac{8/3}{e^{j\Omega} - 2} \\
 &= \frac{-1}{e^{j\Omega} - 0.5} + \frac{8/3}{e^{j\Omega} - 0.8} - \frac{8/3}{e^{j\Omega} - 2} \\
 Y(\omega) &= -\frac{e^{j\Omega}}{e^{j\Omega} - 0.5} + \frac{8}{3}\frac{e^{j\Omega}}{e^{j\Omega} - 0.8} - \frac{8}{3}\frac{e^{j\Omega}}{e^{j\Omega} - 2} \\
 y[k] &= \left[-(0.5)^k + \frac{8}{3}(0.8)^k\right] u[k] + \frac{8}{3}(2)^k u[-(k+1)]
 \end{aligned}$$

9.4-1 (a)

$$f[k] = a^k u[k] - a^k u[k-10] = a^k u[k] - a^{10} a^{k-10} u[k-10]$$

Now

$$a^k u[k] \longleftrightarrow \frac{1}{1 - ae^{-j\Omega}}$$

$$a^{k-10} u[k-10] \longleftrightarrow \frac{1}{1 - ae^{-j\Omega}} e^{-j10\Omega}$$

and

$$f[k] \longleftrightarrow \frac{1}{1 - ae^{-j\Omega}} (1 - a^{10} e^{-j10\Omega})$$

(b) This function is the gate pulse in Example 9.6 delayed by  $k = 4$ . Therefore

$$F(\Omega) = \frac{\sin(4.5\Omega)}{\sin(0.5\Omega)} e^{-j4\Omega}$$

9.4-2 (a)

$$a^k u[k] \longleftrightarrow \frac{1}{1 - ae^{-j\Omega}}$$

$$ka^k u[k] \longleftrightarrow j \frac{d}{d\Omega} \frac{1}{1 - ae^{-j\Omega}} = \frac{ae^{-j\Omega}}{(1 - ae^{-j\Omega})^2}$$

and

$$(k+1)a^k u[k] \longleftrightarrow \frac{1 + ae^{-j\Omega}}{(1 - ae^{-j\Omega})^2}$$

(b)

$$f[k] = a^k \cos \Omega_0 k u[k] = \frac{1}{2} [a^k e^{jk\Omega_0} + a^k e^{-jk\Omega_0}] u[k]$$

$$F(\Omega) = \frac{1}{2} \left[ \frac{1}{1 - ae^{-j(\Omega - \Omega_0)}} + \frac{1}{1 - ae^{-j(\Omega + \Omega_0)}} \right]$$

$$= \frac{1 - ae^{-j\Omega} \cos \Omega_0}{1 - 2ae^{-j\Omega} \cos \Omega_0 + a^2 e^{-j2\Omega}}$$

9.5-1 (a)

$$a^k \cos \Omega_0 k u[k] \longleftrightarrow \frac{z(z - a \cos \Omega_0)}{z^2 - 2az \cos \Omega_0 + a^2}$$

and

$$F(\Omega) = \frac{e^{j\Omega} (e^{j\Omega} - a \cos \Omega_0)}{e^{j2\Omega} - 2ae^{j\Omega} \cos \Omega_0 + a^2} = \frac{1 - ae^{-j\Omega} \cos \Omega_0}{1 - 2ae^{-j\Omega} \cos \Omega_0 + a^2 e^{-j2\Omega}}$$

(b)

$$a^k \sin \Omega_0 k \longleftrightarrow \frac{zs \sin \Omega_0}{z^2 - 2az \cos \Omega_0 + a^2}$$

and

$$F(\Omega) = \frac{e^{j\Omega} a \sin \Omega_0}{e^{j2\Omega} - 2ae^{j\Omega} \cos \Omega_0 + a^2} = \frac{ae^{-j\Omega} \sin \Omega_0}{1 - 2ae^{-j\Omega} \cos \Omega_0 + a^2 e^{-j2\Omega}}$$

(c)

$$a^k u[k-1] = aa^{k-1} u[k-1] \longleftrightarrow \frac{a}{z-a}$$

and

$$F(\Omega) = \frac{a}{e^{j\Omega} - a} = \frac{ae^{-j\Omega}}{1 - ae^{-j\Omega}}$$

(d)

$$a^k u[k+1] = \frac{1}{a} \delta[k+1] + a^k u[k] = \frac{z}{a} + \frac{z}{z-a} = \frac{z^2}{a(z-a)}$$

and

$$F(\Omega) = \frac{e^{j2\Omega}}{a(e^{j\Omega} - a)} = \frac{1}{ae^{-j\Omega}(1 - ae^{-j\Omega})}$$

# Chapter 10

10.1-1 (a)

$$\ddot{y} + 10\dot{y} + 2y = f$$

Choose:  $x_1 = y$  and  $x_2 = \dot{y} = \dot{x}_1 \implies \dot{x}_2 = \ddot{y}$

hence:

$$\begin{aligned} \dot{x}_1 &= x_2 \\ \dot{x}_2 &= -2x_1 - 10x_2 + f \end{aligned}$$

In matrix form we get:

$$\begin{bmatrix} \dot{x}_1 \\ \dot{x}_2 \end{bmatrix} = \begin{bmatrix} 0 & 1 \\ -2 & -10 \end{bmatrix} \begin{bmatrix} x_1 \\ x_2 \end{bmatrix} + \begin{bmatrix} 0 \\ 1 \end{bmatrix} f$$

(b)

$$\ddot{y} + 2e^y \dot{y} + \log y = f$$

Let us choose:  $x_1 = y$  and  $x_2 = \dot{y} = \dot{x}_1$

hence:

$$\begin{aligned} \dot{x}_1 &= x_2 \\ \dot{x}_2 &= -2e^{x_1} x_2 - \log x_1 + f \end{aligned}$$

It is easy to see that this set is nonlinear.

(c)

$$\ddot{y} + \phi_1(y)\dot{y} + \phi_2(y)y = f$$

Let  $x_1 = y$  and  $x_2 = \dot{y}$ . Then

$$\begin{aligned} \dot{x}_1 &= x_2 \\ \dot{x}_2 &= -\phi_1(x_1)x_2 - \phi_2(x_1)x_1 + f \end{aligned}$$

Also in this case we are dealing with a nonlinear set, since  $\phi_2(x_1)$  and  $\phi_1(x_1)$  are not constants.

10.2-1 Writing the loop equations we get:

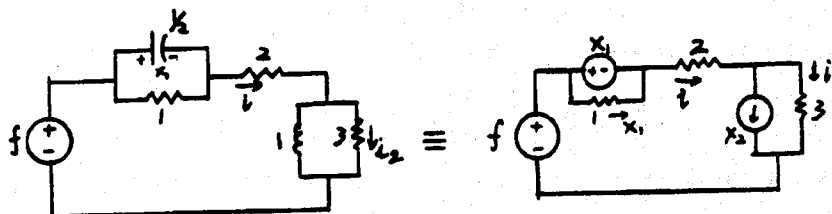

Figure S10.2-1

$$f = x_1 + 2i + 3i_2 \quad \text{where} \quad i_2 = \frac{f - x_1 - \dot{x}_2}{2} - x_2$$

$$\text{and} \quad i = \frac{f - x_1 - \dot{x}_2}{2}$$

$$\text{Also we have:} \quad \frac{1}{2}\dot{x}_1 = \frac{f - x_1 - \dot{x}_2}{2} - x_1$$

$$\text{Therefore} \quad \dot{x}_1 = f - x_1 - \dot{x}_2 - 2x_1 = -3x_1 - \dot{x}_2 + f \quad (1)$$

We can also write:

$$\dot{x}_2 = 3i_2 = 3 \left[ \frac{f - x_1 - \dot{x}_2}{2} - x_2 \right] = \frac{3}{2}f - \frac{3}{2}x_1 - \frac{3}{2}\dot{x}_2 - 3x_2$$

$$\text{Hence} \quad \frac{5}{2}\dot{x}_2 = -\frac{3}{2}x_1 - 3x_2 + \frac{3}{2}f$$

$$\text{or} \quad \dot{x}_2 = -\frac{3}{5}x_1 - \frac{6}{5}x_2 + \frac{3}{5}f \quad (2)$$

Substituting equation (2) in equation (1) we obtain:

$$\dot{x}_1 = -3x_1 + f - \left[ -\frac{3}{5}x_1 - \frac{6}{5}x_2 + \frac{3}{5}f \right] = -\frac{12}{5}x_1 + \frac{6}{5}x_2 + \frac{2}{5}f$$

Hence the state equations are:

$$\begin{bmatrix} \dot{x}_1 \\ \dot{x}_2 \end{bmatrix} = \begin{bmatrix} -\frac{12}{5} & \frac{6}{5} \\ -\frac{3}{5} & -\frac{6}{5} \end{bmatrix} \begin{bmatrix} x_1 \\ x_2 \end{bmatrix} + \begin{bmatrix} \frac{2}{5} \\ \frac{3}{5} \end{bmatrix} f(t)$$

10.2-2 In the 1st loop, the current  $i_1$  can be computed as:

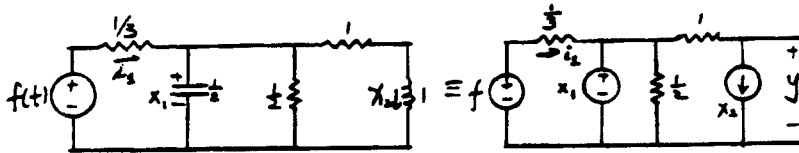

Figure S10.2-2

$$f = \frac{1}{3}i_1 + x_1 \implies i_1 = 3(f - x_1)$$

We also have: (using node equation)

$$\frac{1}{2}\dot{x}_1 = -2x_1 - x_2 - 3x_1 + 3f = -5x_1 - x_2 + 3f$$

$$\text{Hence} \quad \dot{x}_1 = -10x_1 - 2x_2 + 6f \quad (1)$$

Writing the equations in the rightmost loop we get:

$$x_1 = x_2 + \dot{x}_2 \quad \text{and} \quad \dot{x}_2 = x_1 - x_2 \quad (2)$$

Hence from (1) and (2) the state equations are found as:

$$\begin{bmatrix} \dot{x}_1 \\ \dot{x}_2 \end{bmatrix} = \begin{bmatrix} -10 & -2 \\ 1 & -1 \end{bmatrix} \begin{bmatrix} x_1 \\ x_2 \end{bmatrix} + \begin{bmatrix} 6 \\ 0 \end{bmatrix} f$$

The output equation is:  $y = \dot{x}_2 = x_1 - x_2$

$$\text{or} \quad y = [1 \quad -1] \begin{bmatrix} x_1 \\ x_2 \end{bmatrix}$$

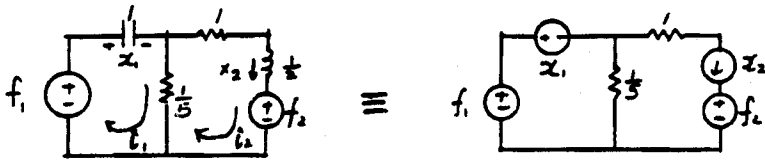

Figure S10.2-3

10.2-3 Let's choose the voltage across the capacitor and the current through the inductor as state variables  $x_1$  and  $x_2$ , respectively.

Writing the loop equations we get:

$$f_1 = x_1 + \frac{1}{5}(\dot{x}_1 - x_2)$$

Here we use the fact that:  $\dot{x}_1 = i_1$  and  $x_2 = i_2$ .

$$f_2 = -\frac{1}{2}\dot{x}_2 - x_2 + \frac{1}{5}(\dot{x}_1 - x_2)$$

And thus:  $\dot{x}_1 = -5x_1 + x_2 + 5f_1$

$$\dot{x}_2 = -2x_1 - 2x_2 + 2f_1 - 2f_2$$

Hence the state equations are

$$\begin{bmatrix} \dot{x}_1 \\ \dot{x}_2 \end{bmatrix} = \begin{bmatrix} -5 & 1 \\ -2 & -2 \end{bmatrix} \begin{bmatrix} x_1 \\ x_2 \end{bmatrix} + \begin{bmatrix} 5 & 0 \\ 2 & -2 \end{bmatrix} \begin{bmatrix} f_1 \\ f_2 \end{bmatrix}$$

10.2-4 The loop equations yield:

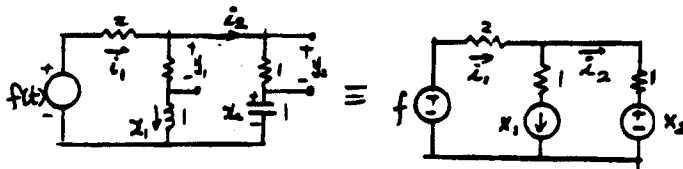

Figure S10.2-4

with  $i_2 = \dot{x}_2$  and  $i_1 = x_1 + i_2 = x_1 + \dot{x}_2$

$$f = 2i_1 + x_1 + \dot{x}_1 = 2x_1 + 2\dot{x}_2 + x_1 + \dot{x}_1 = 3x_1 + \dot{x}_1 + 2\dot{x}_2 \quad (1)$$

$$f = 2i_1 + \dot{x}_2 + x_2 = 2x_1 + 2\dot{x}_2 + \dot{x}_2 + x_2 = 2x_1 + x_2 + 3\dot{x}_2 \quad (2)$$

The last equation gives:

$$\dot{x}_2 = -\frac{2}{3}x_1 - \frac{1}{3}x_2 + \frac{1}{3}f \quad (3)$$

Substituting  $\dot{x}_2$  in the equation (1) we get:

$$\dot{x}_1 = -\frac{5}{3}x_1 + \frac{2}{3}x_2 + \frac{5}{3}f \quad (4)$$

From (3) and (4) the state equations are obtained as:

$$\begin{bmatrix} \dot{x}_1 \\ \dot{x}_2 \end{bmatrix} = \begin{bmatrix} -\frac{5}{3} & \frac{2}{3} \\ -\frac{2}{3} & -\frac{1}{3} \end{bmatrix} \begin{bmatrix} x_1 \\ x_2 \end{bmatrix} + \begin{bmatrix} \frac{5}{3} \\ \frac{1}{3} \end{bmatrix} f(t)$$

And the output equations are:  $y_1 = x_1$  and



$$y_2 = i_2 = \dot{x}_2 = -\frac{2}{3}x_1 - \frac{1}{3}x_2 + \frac{1}{3}f$$

$$y = \begin{bmatrix} y_1 \\ y_2 \end{bmatrix} = \begin{bmatrix} 1 & 0 \\ -\frac{2}{3} & -\frac{1}{3} \end{bmatrix} \begin{bmatrix} x_1 \\ x_2 \end{bmatrix} + \begin{bmatrix} 0 \\ \frac{1}{3} \end{bmatrix} f(t)$$

10.2-5

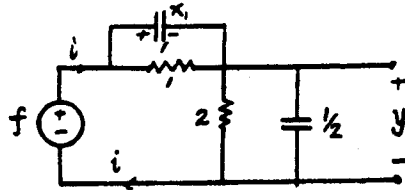

Figure S10.2-5

We have:

$$\begin{aligned} i &= x_1 + \dot{x}_1 \\ &= \frac{f - x_1}{2} + \frac{\dot{f} - \dot{x}_1}{2} \end{aligned}$$

Multiplying both sides of this equations by 2, we get:

$$\begin{aligned} 2x_1 + 2\dot{x}_1 &= f - x_1 + \dot{f} - \dot{x}_1 \\ \text{or } 3\dot{x}_1 &= -3x_1 + f + \dot{f} \end{aligned}$$

$$\text{Hence } \dot{x}_1 = -x_1 + \frac{f}{3} + \frac{\dot{f}}{3}$$

Thus the only state equation is:

$$\dot{x}_1 = -x_1 + \frac{f}{3} + \frac{\dot{f}}{3}$$

The output equation is:  $y = -x_1 + f$ .

Note that although there are two capacitors, there is only one independent capacitor voltage, because the two capacitors form a loop with the voltage source. In such a case the state equation contains the terms  $f$  as well as  $\dot{f}$ . Similar situation exists when inductors along with current source(s) for a cut set.

10.2-6 Let us choose  $x_1$ ,  $x_2$  and  $x_3$  as the outputs of the subsystem shown in the figure:

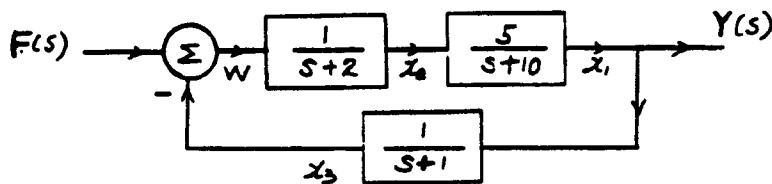

Figure S10.2-6

From the block diagram we obtain:

$$5x_2 = \dot{x}_1 + 10x_1 \implies \dot{x}_1 = -10x_1 + 5x_2 \quad (1)$$

$$x_1 = \dot{x}_3 + x_3 \implies \dot{x}_3 = x_1 - x_3 \quad (2)$$

$$w = \dot{x}_2 + 2x_2 \implies \dot{x}_2 = w - 2x_2 \quad (3)$$

$$\dot{x}_2 = -2x_2 - x_3 + f$$

From (1), (2) and (3) the state equations can be written as:

$$\begin{bmatrix} \dot{x}_1 \\ \dot{x}_2 \\ \dot{x}_3 \end{bmatrix} = \begin{bmatrix} -10 & 5 & 0 \\ 0 & -2 & -1 \\ 1 & 0 & -1 \end{bmatrix} \begin{bmatrix} x_1 \\ x_2 \\ x_3 \end{bmatrix} + \begin{bmatrix} 0 \\ 1 \\ 0 \end{bmatrix} f$$

And the output equation is:

$$y = x_1 = \begin{bmatrix} 1 & 0 & 0 \end{bmatrix} \begin{bmatrix} x_1 \\ x_2 \\ x_3 \end{bmatrix}$$

10.2-7 From Fig. P10.2-7, it is easy to write the state equations as:

$$\dot{x}_1 = \lambda_1 x_1$$

$$\dot{x}_2 = \lambda_2 x_2 + f_1$$

$$\dot{x}_3 = \lambda_3 x_3 + f_2$$

$$\dot{x}_4 = \lambda_4 x_4 + f_2$$

or

$$\begin{bmatrix} \dot{x}_1 \\ \dot{x}_2 \\ \dot{x}_3 \\ \dot{x}_4 \end{bmatrix} = \begin{bmatrix} \lambda_1 & 0 & 0 & 0 \\ 0 & \lambda_2 & 0 & 0 \\ 0 & 0 & \lambda_3 & 0 \\ 0 & 0 & 0 & \lambda_4 \end{bmatrix} \begin{bmatrix} x_1 \\ x_2 \\ x_3 \\ x_4 \end{bmatrix} + \begin{bmatrix} 0 & 0 \\ 1 & 0 \\ 0 & 1 \\ 0 & 1 \end{bmatrix} \begin{bmatrix} f_1 \\ f_2 \end{bmatrix}$$

The output equation is:

$$\begin{aligned} y_1 &= x_1 + x_2 \\ y_2 &= x_2 + x_3 \end{aligned} \implies \begin{bmatrix} y_1 \\ y_2 \end{bmatrix} = \begin{bmatrix} 1 & 1 & 0 & 0 \\ 0 & 1 & 1 & 0 \end{bmatrix} \begin{bmatrix} x_1 \\ x_2 \\ x_3 \\ x_4 \end{bmatrix}$$

10.2-8

$$H(s) = \frac{3s + 10}{s^2 + 7s + 12}$$

Controller canonical form:

We can write the state and output equations straightforward from the transfer function  $H(s)$ .

Thus we get:

$$\begin{bmatrix} \dot{x}_1 \\ \dot{x}_2 \end{bmatrix} = \begin{bmatrix} 0 & 1 \\ -12 & -7 \end{bmatrix} \begin{bmatrix} x_1 \\ x_2 \end{bmatrix} + \begin{bmatrix} 0 \\ 1 \end{bmatrix} f$$

$$y = \begin{bmatrix} 10 & 3 \end{bmatrix} \begin{bmatrix} x_1 \\ x_2 \end{bmatrix}$$

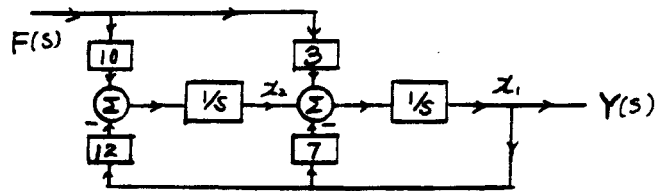

Figure S10.2-8a: observer canonical

Observer canonical form: In this case the block diagram can be drawn as shown in Fig. S6.10a.

$$\text{hence: } \begin{aligned} \dot{x}_1 &= -7x_1 + x_2 + 3f \\ \dot{x}_2 &= -12x_1 + 10f \end{aligned}$$

or

$$\begin{bmatrix} \dot{x}_1 \\ \dot{x}_2 \end{bmatrix} = \begin{bmatrix} -7 & 1 \\ -12 & 0 \end{bmatrix} \begin{bmatrix} x_1 \\ x_2 \end{bmatrix} + \begin{bmatrix} 3 \\ 10 \end{bmatrix} f$$

The output equation is:

$$y = x_1 = [1 \ 0] \begin{bmatrix} x_1 \\ x_2 \end{bmatrix}$$

The cascade form:

$$H(s) = \frac{3s + 10}{s^2 + 7s + 12} = \left( \frac{3s + 10}{s + 4} \right) \left( \frac{1}{s + 3} \right)$$

Hence we can write:

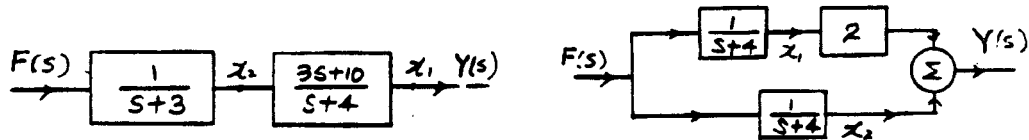

Figure S10.2-8b: cascade and parallel

$$\left. \begin{aligned} \dot{x}_1 + 4x_1 &= 3\dot{x}_2 + 10x_2 \\ \dot{x}_2 &= -3x_2 + f \end{aligned} \right\} \Rightarrow \begin{aligned} \dot{x}_1 &= -4x_1 - 9x_2 + 10x_2 + 3f \\ \dot{x}_2 &= -3x_2 + f \end{aligned}$$

$$\begin{bmatrix} \dot{x}_1 \\ \dot{x}_2 \end{bmatrix} = \begin{bmatrix} -4 & 1 \\ 0 & -3 \end{bmatrix} \begin{bmatrix} x_1 \\ x_2 \end{bmatrix} + \begin{bmatrix} 3 \\ 1 \end{bmatrix} f$$

and

$$y = x_1 = [1 \ 0] \begin{bmatrix} x_1 \\ x_2 \end{bmatrix}$$

Parallel form:

$$H(s) = \frac{2}{s + 4} + \frac{1}{s + 3}$$

$$\begin{aligned} \dot{x}_1 &= -4x_1 + f \\ \dot{x}_2 &= -3x_2 + f \end{aligned} \Rightarrow \begin{bmatrix} \dot{x}_1 \\ \dot{x}_2 \end{bmatrix} = \begin{bmatrix} -4 & 0 \\ 0 & -3 \end{bmatrix} \begin{bmatrix} x_1 \\ x_2 \end{bmatrix} + \begin{bmatrix} 1 \\ 1 \end{bmatrix} f$$

And the output equation is:

$$y = 2x_1 + x_2 = [2 \ 1] \begin{bmatrix} x_1 \\ x_2 \end{bmatrix}$$

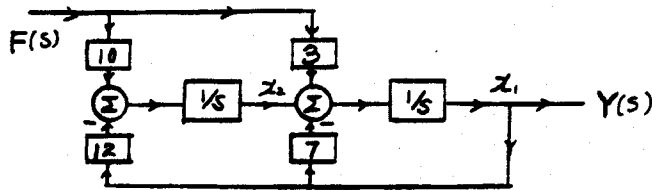

Figure S10.2-8a: observer canonical

Observer canonical form: In this case the block diagram can be drawn as shown in Fig. S6.10a.

hence:  $\dot{x}_1 = -7x_1 + x_2 + 3f$   
 $\dot{x}_2 = -12x_1 + 10f$

or

$$\begin{bmatrix} \dot{x}_1 \\ \dot{x}_2 \end{bmatrix} = \begin{bmatrix} -7 & 1 \\ -12 & 0 \end{bmatrix} \begin{bmatrix} x_1 \\ x_2 \end{bmatrix} + \begin{bmatrix} 3 \\ 10 \end{bmatrix} f$$

The output equation is:

$$y = x_1 = [1 \ 0] \begin{bmatrix} x_1 \\ x_2 \end{bmatrix}$$

The cascade form:

$$H(s) = \frac{3s + 10}{s^2 + 7s + 12} = \left( \frac{3s + 10}{s + 4} \right) \left( \frac{1}{s + 3} \right)$$

Hence we can write:

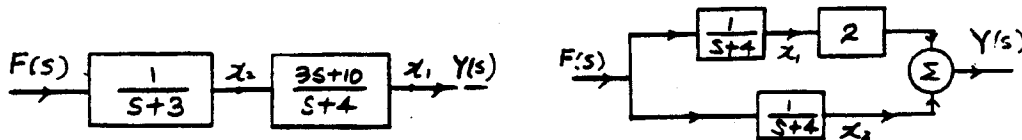

Figure S10.2-8b: cascade and parallel

$$\left. \begin{aligned} \dot{x}_1 + 4x_1 &= 3\dot{x}_2 + 10x_2 \\ \dot{x}_2 &= -3x_2 + f \end{aligned} \right\} \Rightarrow \begin{aligned} \dot{x}_1 &= -4x_1 - 9x_2 + 10x_2 + 3f \\ \dot{x}_2 &= -3x_2 + f \end{aligned}$$

$$\begin{bmatrix} \dot{x}_1 \\ \dot{x}_2 \end{bmatrix} = \begin{bmatrix} -4 & 1 \\ 0 & -3 \end{bmatrix} \begin{bmatrix} x_1 \\ x_2 \end{bmatrix} + \begin{bmatrix} 3 \\ 1 \end{bmatrix} f$$

and

$$y = x_1 = [1 \ 0] \begin{bmatrix} x_1 \\ x_2 \end{bmatrix}$$

Parallel form:

$$H(s) = \frac{2}{s + 4} + \frac{1}{s + 3}$$

$$\left. \begin{aligned} \dot{x}_1 &= -4x_1 + f \\ \dot{x}_2 &= -3x_2 + f \end{aligned} \right\} \Rightarrow \begin{bmatrix} \dot{x}_1 \\ \dot{x}_2 \end{bmatrix} = \begin{bmatrix} -4 & 0 \\ 0 & -3 \end{bmatrix} \begin{bmatrix} x_1 \\ x_2 \end{bmatrix} + \begin{bmatrix} 1 \\ 1 \end{bmatrix} f$$

And the output equation is:

$$y = 2x_1 + x_2 = [2 \ 1] \begin{bmatrix} x_1 \\ x_2 \end{bmatrix}$$

10.2-9 (a)

$$H(s) = \frac{4s}{(s+1)(s+2)^2} = \frac{4s}{s^3 + 5s^2 + 8s + 4}$$

Controller canonical form:

$$\begin{bmatrix} \dot{x}_1 \\ \dot{x}_2 \\ \dot{x}_3 \end{bmatrix} = \begin{bmatrix} 0 & 1 & 0 \\ 0 & 0 & 1 \\ -4 & -8 & -5 \end{bmatrix} \begin{bmatrix} x_1 \\ x_2 \\ x_3 \end{bmatrix} + \begin{bmatrix} 0 \\ 0 \\ 1 \end{bmatrix} f$$

And

$$y = [0 \ 4 \ 0] \begin{bmatrix} x_1 \\ x_2 \\ x_3 \end{bmatrix}$$

Observer canonical form:

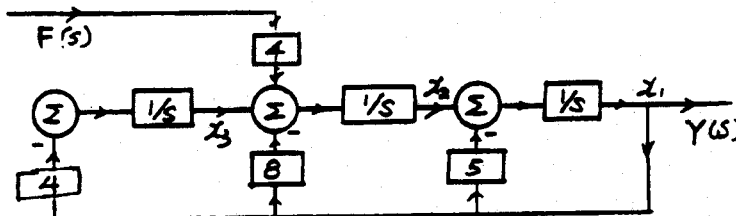

Fig. S10.2-9a: observer canonical

In this case:

$$\dot{x}_1 = -5x_1 + x_2$$

$$\dot{x}_2 = -8x_2 + x_3 + 4f$$

$$\dot{x}_3 = -x_3$$

$$\begin{bmatrix} \dot{x}_1 \\ \dot{x}_2 \\ \dot{x}_3 \end{bmatrix} = \begin{bmatrix} -5 & 1 & 0 \\ -8 & 0 & 1 \\ -4 & 0 & 0 \end{bmatrix} \begin{bmatrix} x_1 \\ x_2 \\ x_3 \end{bmatrix} + \begin{bmatrix} 0 \\ 4 \\ 0 \end{bmatrix} f$$

And:

$$y = x_1 = [1 \ 0 \ 0] \begin{bmatrix} x_1 \\ x_2 \\ x_3 \end{bmatrix}$$

Cascade form:

$$H(s) = \left( \frac{1}{s+1} \right) \left( \frac{4s}{s+2} \right) \left( \frac{1}{s+2} \right)$$

From the block diagram we have:

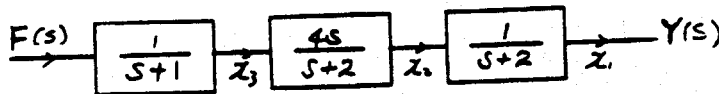

Figure S10.2-9a: cascade

And the output is:

$$y = [0 \ 12 \ 7 \ 1] \begin{bmatrix} x_1 \\ x_2 \\ x_3 \\ x_4 \end{bmatrix}$$

Observer canonical form:

We can write the state equation directly from  $H(s)$  as in the first canonical form.

$$\begin{bmatrix} \dot{x}_1 \\ \dot{x}_2 \\ \dot{x}_3 \\ \dot{x}_4 \end{bmatrix} = \begin{bmatrix} -5 & 1 & 0 & 0 \\ -9 & 0 & 1 & 0 \\ -7 & 0 & 0 & 1 \\ -2 & 0 & 0 & 0 \end{bmatrix} \begin{bmatrix} x_1 \\ x_2 \\ x_3 \\ x_4 \end{bmatrix} + \begin{bmatrix} 1 \\ 7 \\ 12 \\ 0 \end{bmatrix} f$$

And

$$y = x_1 = [1 \ 0 \ 0 \ 0] \begin{bmatrix} x_1 \\ x_2 \\ x_3 \\ x_4 \end{bmatrix}$$

Cascade form:

$$H(s) = \frac{s(s+3)(s+4)}{(s+2)(s+1)^3} = \left( \frac{1}{s+2} \right) \left( \frac{s}{s+1} \right) \left( \frac{s+3}{s+1} \right) \left( \frac{s+4}{s+1} \right)$$

Cascade form: From the block diagram we obtain:

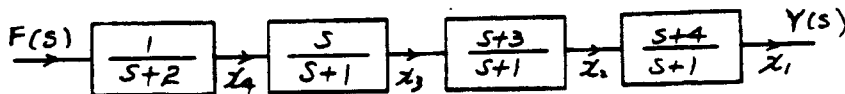

Figure S10.2-9b: cascade

$$\begin{cases} \dot{x}_1 + x_1 = \dot{x}_2 + 4x_2 \\ \dot{x}_2 + x_2 = \dot{x}_3 + 3x_3 \\ \dot{x}_3 = -x_3 + \dot{x}_4 \\ \dot{x}_4 = -2x_4 + f \end{cases} \Rightarrow \begin{cases} \dot{x}_1 = -x_1 + 4x_2 - x_2 + 2x_3 - 2x_4 + f \\ \dot{x}_2 = -x_2 + 3x_3 - x_3 - 2x_4 + f \\ \dot{x}_3 = -x_3 - 2x_4 + f \\ \dot{x}_4 = -2x_4 + f \end{cases}$$

hence:

$$\begin{bmatrix} \dot{x}_1 \\ \dot{x}_2 \\ \dot{x}_3 \\ \dot{x}_4 \end{bmatrix} = \begin{bmatrix} -1 & 3 & 2 & -2 \\ 0 & -1 & 2 & -2 \\ 0 & 0 & -1 & -2 \\ 0 & 0 & 0 & -2 \end{bmatrix} \begin{bmatrix} x_1 \\ x_2 \\ x_3 \\ x_4 \end{bmatrix} + \begin{bmatrix} 1 \\ 1 \\ 1 \\ 1 \end{bmatrix} f$$

And

$$y = x_1 = [1 \ 0 \ 0 \ 0] \begin{bmatrix} x_1 \\ x_2 \\ x_3 \\ x_4 \end{bmatrix}$$

Parallel form: we can rewrite  $H(s)$  as (after partial fraction expansion)

$$H(s) = \frac{6}{s+2} + \frac{11}{s+1} + \frac{7}{(s+1)^2} - \frac{6}{(s+1)^3}$$

$$\begin{aligned}\dot{x}_1 &= -2x_1 + f \\ \dot{x}_2 &= -x_2 + x_3 \\ \dot{x}_3 &= -x_3 + x_4 \\ \dot{x}_4 &= -x_4 + f\end{aligned}$$

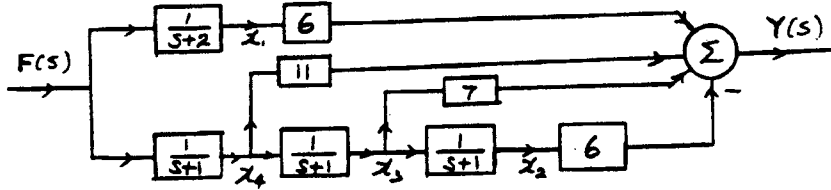

Figure S10.2-9b: parallel

From the block diagram, we have

$$\begin{bmatrix} \dot{x}_1 \\ \dot{x}_2 \\ \dot{x}_3 \\ \dot{x}_4 \end{bmatrix} = \begin{bmatrix} -2 & 0 & 0 & 0 \\ 0 & -2 & 1 & 0 \\ 0 & 0 & -1 & 1 \\ 0 & 0 & 0 & -1 \end{bmatrix} \begin{bmatrix} x_1 \\ x_2 \\ x_3 \\ x_4 \end{bmatrix} + \begin{bmatrix} 1 \\ 0 \\ 0 \\ 1 \end{bmatrix} f$$

And the output can be written as:

$$y = 6x_1 - 6x_2 + 7x_3 + 11x_4$$

or

$$y = \begin{bmatrix} 6 & -6 & 7 & 11 \end{bmatrix} \begin{bmatrix} x_1 \\ x_2 \\ x_3 \\ x_4 \end{bmatrix}$$

10.3-1

$$\dot{x} = Ax + Bf$$

The solution of the state equation in the frequency domain is given by:

$$x(s) = \Phi(s)x(0) + \Phi(s)BF(s)$$

but in this case  $f(t) = 0 \Rightarrow F(s) = 0$

hence:  $x(s) = \Phi(s)x(0)$  where  $\Phi(s) = (sI - A)^{-1}$

$$\Phi(s) = (sI - A)^{-1} \quad (sI - A) = \begin{bmatrix} s & 0 \\ 0 & s \end{bmatrix} - \begin{bmatrix} 0 & 2 \\ -1 & -3 \end{bmatrix}$$

$$sI - A = \begin{bmatrix} s & -2 \\ 1 & s+3 \end{bmatrix} \Rightarrow \Phi(s) = (sI - A)^{-1} = \begin{bmatrix} s+3 & 2 \\ -1 & s \end{bmatrix} \frac{1}{s^2 + 3s + 2}$$

$$\Phi(s) = \begin{bmatrix} \frac{s+3}{s^2+3s+2} & \frac{2}{s^2+3s+2} \\ \frac{-1}{s^2+3s+2} & \frac{s}{s^2+3s+2} \end{bmatrix} = \begin{bmatrix} \frac{s+3}{(s+1)(s+2)} & \frac{2}{(s+1)(s+2)} \\ \frac{-1}{(s+1)(s+2)} & \frac{s}{(s+1)(s+2)} \end{bmatrix}$$

And hence:  $x(s) = \Phi(s)x(0)$

$$x(s) = \begin{bmatrix} \frac{2(s+3)+2}{(s+1)(s+2)} \\ \frac{-2+s}{(s+1)(s+2)} \end{bmatrix} = \begin{bmatrix} \frac{2s+8}{(s+1)(s+2)} \\ \frac{s-2}{(s+1)(s+2)} \end{bmatrix} = \begin{bmatrix} \frac{6}{s+1} - \frac{4}{s+2} \\ \frac{-3}{s+1} + \frac{4}{s+2} \end{bmatrix}$$

And finally:

$$\mathbf{x}(t) = \begin{bmatrix} x_1(t) \\ x_2(t) \end{bmatrix} = \mathcal{L}^{-1} \{ \mathbf{x}(s) \} = \begin{bmatrix} (6e^{-t} - 4e^{-2t})u(t) \\ (-3e^{-t} + 4e^{-2t})u(t) \end{bmatrix}$$

10.3-2

$$\mathbf{x}(s) = \Phi(s)\mathbf{x}(0) + \Phi(s)\mathbf{B}\mathbf{F}(s) = \Phi(s)[\mathbf{x}(0) + \mathbf{B}\mathbf{F}(s)]$$

$$(s\mathbf{I} - \mathbf{A}) = \begin{bmatrix} s+5 & 6 \\ -1 & s \end{bmatrix} \quad \text{and} \quad \Phi(s) = (s\mathbf{I} - \mathbf{A})^{-1} = \frac{1}{s^2 + 5s + 6} \begin{bmatrix} s & -6 \\ 1 & s+5 \end{bmatrix}$$

$$\Phi(s) = \begin{bmatrix} \frac{(s+3)(s+2)}{(s+3)(s+2)} & \frac{-6}{(s+3)(s+2)} \\ \frac{1}{(s+3)(s+2)} & \frac{s+5}{(s+3)(s+2)} \end{bmatrix}$$

And hence:

$$\begin{aligned} \mathbf{x}(s) = \Phi(s)[\mathbf{x}(0) + \mathbf{B}\mathbf{F}(s)] &= \begin{bmatrix} \frac{(s+3)(s+2)}{(s+3)(s+2)} & \frac{-6}{(s+3)(s+2)} \\ \frac{1}{(s+3)(s+2)} & \frac{s+5}{(s+3)(s+2)} \end{bmatrix} \begin{bmatrix} 5 + \frac{100}{s^2+10s} \\ 4 \end{bmatrix} \\ &= \begin{bmatrix} \frac{-34.02}{s+3} + \frac{39.03}{s+2} - \frac{10^{-2}s}{s^2+10s} \\ \frac{17.01}{s+3} - \frac{13.01}{s+2} - \frac{0}{s^2+10s} \end{bmatrix} \end{aligned}$$

hence:  $\mathbf{x}(t) = \mathcal{L}^{-1}(\mathbf{x}(s))$

$$\mathbf{x}(s) = \begin{bmatrix} x_1(t) \\ x_2(t) \end{bmatrix} = \begin{bmatrix} -34.02e^{-2t} + 39.03e^{-3t} - 0.01 \cos 100t \\ 17.01e^{-2t} - 13.01e^{-3t} \end{bmatrix}$$

10.3-3

$$\mathbf{x}(s) = \Phi(s)[\mathbf{x}(0) + \mathbf{B}\mathbf{F}(s)]$$

$$\begin{aligned} (s\mathbf{I} - \mathbf{A}) &= \begin{bmatrix} s+2 & 0 \\ -1 & s+1 \end{bmatrix} \quad \text{and} \quad \Phi(s) = (s\mathbf{I} - \mathbf{A})^{-1} = \frac{1}{(s+1)(s+2)} \begin{bmatrix} s+1 & 0 \\ 1 & s+2 \end{bmatrix} \\ &= \begin{bmatrix} \frac{1}{s+2} & 0 \\ \frac{1}{(s+1)(s+2)} & \frac{1}{s+1} \end{bmatrix} \end{aligned}$$

Also  $f(t) = u(t) \Rightarrow F(s) = \frac{1}{s}$

$$\text{Hence: } \mathbf{B}\mathbf{F}(s) = \begin{bmatrix} \frac{1}{s} \\ 0 \end{bmatrix} \quad \text{And} \quad \mathbf{x}(0) + \mathbf{B}\mathbf{F}(s) = \begin{bmatrix} \frac{1}{s} \\ -1 \end{bmatrix}$$

And thus:

$$\begin{aligned} \mathbf{x}(s) &= \begin{bmatrix} \frac{1}{s+2} & 0 \\ \frac{1}{(s+1)(s+2)} & \frac{1}{s+1} \end{bmatrix} \begin{bmatrix} \frac{1}{s} \\ -1 \end{bmatrix} = \begin{bmatrix} \frac{1}{s(s+2)} \\ \frac{1}{s(s+1)(s+2)} - \frac{1}{s+1} \end{bmatrix} \\ &= \begin{bmatrix} \frac{1}{s} - \frac{1}{2(s+2)} \\ \frac{1}{s} - \frac{1}{s+1} - \frac{1}{2(s+2)} \end{bmatrix} \end{aligned}$$

Hence:

$$\mathbf{x}(t) = \mathcal{L}^{-1}(\mathbf{x}(s)) = \begin{bmatrix} x_1(t) \\ x_2(t) \end{bmatrix} = \begin{bmatrix} (\frac{1}{s} - \frac{1}{2}e^{-2t})u(t) \\ ((\frac{1}{s} - 2e^{-t} + \frac{1}{2}e^{-2t})u(t)) \end{bmatrix}$$



10.3-4

$$x(s) = \Phi(s)[x(0) + BF(s)]$$

$$(sI - A) = \begin{bmatrix} s+1 & -1 \\ 0 & s+2 \end{bmatrix} \text{ and } \Phi(s) = (sI - A)^{-1} = \frac{1}{(s+1)(s+2)} \begin{bmatrix} s+2 & 1 \\ 0 & s+1 \end{bmatrix}$$

$$\Phi(s) = \begin{bmatrix} \frac{1}{s+1} & \frac{1}{(s+1)(s+2)} \\ 0 & \frac{1}{s+2} \end{bmatrix}$$

$$\text{and } f(t) = \begin{bmatrix} u(t) \\ \delta(t) \end{bmatrix} \Rightarrow F(s) = \begin{bmatrix} \frac{1}{s} \\ 1 \end{bmatrix}$$

$$BF(s) = \begin{bmatrix} 1 & 1 \\ 0 & 1 \end{bmatrix} \begin{bmatrix} \frac{1}{s} \\ 1 \end{bmatrix} = \begin{bmatrix} \frac{s+1}{s} \\ 1 \end{bmatrix}$$

$$\text{and: } x(0) + BF(s) = \begin{bmatrix} \frac{s+1}{s} + 1 \\ 3 \end{bmatrix} = \begin{bmatrix} \frac{2s+1}{s} + 1 \\ 3 \end{bmatrix}$$

$$\begin{aligned} x(s) = \Phi(s)[x(0) + BF(s)] &= \begin{bmatrix} \frac{1}{s+1} & \frac{1}{(s+1)(s+2)} \\ 0 & \frac{1}{s+2} \end{bmatrix} \begin{bmatrix} \frac{2s+1}{s} \\ 3 \end{bmatrix} \\ &= \begin{bmatrix} \frac{(2s+1)(s+2) + 3s}{s(s+1)(s+2)} \\ \frac{3}{s+2} \end{bmatrix} = \begin{bmatrix} \frac{1}{s} + \frac{4}{s+1} - \frac{3}{s+2} \\ \frac{3}{s+2} \end{bmatrix} \end{aligned}$$

And hence:

$$x(t) = \mathcal{L}^{-1}(x(s)) = \begin{bmatrix} x_1(t) \\ x_2(t) \end{bmatrix} = \begin{bmatrix} (1 + 4e^{-t} - 3e^{-2t})u(t) \\ 3e^{-2t}u(t) \end{bmatrix}$$

10.3-5

$$Y(s) = CX(s) + DF(s) = C\Phi(s)x(0) + [C\Phi(s)B + D]F(s)$$

$$(sI - A) = \begin{bmatrix} s+3 & -1 \\ 2 & s \end{bmatrix} \text{ and } \Phi(s) = (sI - A)^{-1} = \frac{1}{(s+1)(s+2)} \begin{bmatrix} s & 1 \\ -2 & s+3 \end{bmatrix}$$

$$\Phi(s) = \begin{bmatrix} \frac{s}{(s+1)(s+2)} & \frac{1}{(s+1)(s+2)} \\ \frac{-2}{(s+1)(s+2)} & \frac{s+3}{(s+1)(s+2)} \end{bmatrix} \text{ and } BF(s) = \begin{bmatrix} \frac{1}{s} \\ 1 \end{bmatrix}$$

Since  $D = 0 \Rightarrow Y(s) = C\Phi(s)[x(0) + BF(s)]$ 

$$\text{So } x(0) + BF(s) = \begin{bmatrix} 2 + \frac{1}{s} \\ 0 \end{bmatrix} = \begin{bmatrix} \frac{2s+1}{s} \\ 0 \end{bmatrix}$$

and

$$\Phi(s)[x(0) + BF(s)] = \begin{bmatrix} \frac{s}{(s+1)(s+2)} & \frac{1}{(s+1)(s+2)} \\ \frac{-2}{(s+1)(s+2)} & \frac{s+3}{(s+1)(s+2)} \end{bmatrix} \begin{bmatrix} \frac{2s+1}{s} \\ 0 \end{bmatrix} = \begin{bmatrix} \frac{2s+1}{(s+1)(s+2)} \\ \frac{-2(2s+1)}{s(s+1)(s+2)} \end{bmatrix}$$

$$Y(s) = C\Phi(s)[x(0) + BF(s)] = [0 \quad 1] \begin{bmatrix} \frac{2s+1}{(s+1)(s+2)} \\ \frac{-2(2s+1)}{s(s+1)(s+2)} \end{bmatrix}$$

$$Y(s) = \frac{-4s-2}{s(s+1)(s+2)} = \frac{-1}{s} - 2 \cdot \frac{1}{s+1} + \frac{3}{s+2}$$

$$y(t) = \mathcal{L}^{-1}[y(s)] = (-1 - 2e^{-t} + 3e^{-2t})u(t)$$

10.3-6

$$y(s) = CX(s) + DF(s) = C\Phi(s)x(0) + [C\Phi(s)B + D]F(s)$$

$$= C\{\Phi(s)[x(0) + BF(s)]\} + DF(s)$$

$$(sI - A) = \begin{bmatrix} s+1 & -1 \\ 1 & s+1 \end{bmatrix} \text{ and } \Phi(s) = (sI - A)^{-1} = \frac{1}{s^2 + 2s + 2} \begin{bmatrix} s+1 & 1 \\ -1 & s+1 \end{bmatrix}$$

$$= \begin{bmatrix} \frac{s+1}{s^2+2s+2} & \frac{1}{s^2+2s+2} \\ \frac{-1}{s^2+2s+2} & \frac{s+1}{s^2+2s+2} \end{bmatrix}$$

$$BF(s) = \begin{bmatrix} 0 \\ 1 \end{bmatrix} \quad \text{and} \quad x(0) + BF(s) = \begin{bmatrix} 2 \\ s+1 \end{bmatrix}$$

$$\text{Hence } \Phi(s)[x(0) + BF(s)] = \begin{bmatrix} \frac{s+1}{(s+1)^2+1} & \frac{1}{(s+1)^2+1} \\ \frac{-1}{(s+1)^2+1} & \frac{s+1}{(s+1)^2+1} \end{bmatrix} \begin{bmatrix} 2 \\ s+1 \end{bmatrix}$$

$$= \begin{bmatrix} \frac{2(s+1)}{(s+1)^2+1} + \frac{1}{s((s+1)^2+1)} \\ \frac{-2}{(s+1)^2+1} + \frac{(s+1)^2}{s((s+1)^2+1)} \end{bmatrix} = \begin{bmatrix} \frac{2s^2+3s+1}{s((s+1)^2+1)} \\ \frac{s^2+1}{s((s+1)^2+1)} \end{bmatrix}$$

$$C\Phi(s)[x(0) + BF(s)] = [1 \ 1] \Phi(s)[x(0) + BF(s)] = \frac{2s^2 + 3s + 1 + s^2 + 1}{s((s+1)^2 + 1)}$$

Also:  $DF(s) = \frac{1}{s}$

Hence

$$Y(s) = C\Phi(s)[x(0) + BF(s)] + DF(s) = \frac{3s^2 + 3s + 2}{s((s+1)^2 + 1)} + \frac{1}{s} = \frac{4s^2 + 5s + 4}{s((s+1)^2 + 1)}$$

$$Y(s) = \frac{4s^2 + 5s + 4}{s(s^2 + 2s + 2)} = \frac{C}{s} + \frac{As + B}{s^2 + 2s + 2}$$

Using partial fractions and clearing fractions we get:

$$Y(s) = \frac{2}{s} + \frac{2s+1}{(s+1)^2+1^2} = \frac{2}{s} + 2 \frac{(s+1)}{(s+1)^2+1^2} - \frac{1}{(s+1)^2+1^2}$$

$$\text{and } y(t) = \mathcal{L}^{-1}[Y(s)] = (2 + 2e^{-t} \cos t - e^{-t} \sin t)u(t)$$

10.3-7

$$H(s) = \left( \frac{1}{s+3} \right) \left( \frac{3s+10}{s+4} \right) = \frac{3s+10}{s^2+7s+12}$$

This is the same transfer function as in Prob. 10.2-8, where the cascade form state equations were found to be

$$\begin{bmatrix} \dot{x}_1 \\ \dot{x}_2 \end{bmatrix} = \begin{bmatrix} -4 & 1 \\ 0 & -3 \end{bmatrix} \begin{bmatrix} x_1 \\ x_2 \end{bmatrix} + \begin{bmatrix} 3 \\ 1 \end{bmatrix} f$$

$$\text{And } y = x_1 = \begin{bmatrix} 1 & 0 \end{bmatrix} \begin{bmatrix} x_1 \\ x_2 \end{bmatrix}$$

In this case

$$sI - A = \begin{bmatrix} s+4 & -1 \\ 0 & s+3 \end{bmatrix} \text{ and } \Phi(s) = (sI - A)^{-1} = \frac{1}{(s+3)(s+4)} \begin{bmatrix} s+3 & 1 \\ 0 & s+4 \end{bmatrix}$$

$$= \begin{bmatrix} \frac{1}{s+4} & \frac{1}{(s+3)(s+4)} \\ 0 & \frac{1}{s+3} \end{bmatrix}$$

Also in our case:

$$C = [1 \ 0] \quad \text{and} \quad B = \begin{bmatrix} 3 \\ 1 \end{bmatrix} \quad \text{and} \quad D = 0$$

Hence

$$\Phi(s)\mathbf{B} = \begin{bmatrix} \frac{1}{s+4} & \frac{1}{(s+3)(s+4)} \\ 0 & \frac{1}{s+3} \end{bmatrix} \begin{bmatrix} 3 \\ 1 \end{bmatrix} = \begin{bmatrix} \frac{3(s+3)+1}{(s+3)(s+4)} \\ \frac{1}{s+3} \end{bmatrix} = \begin{bmatrix} \frac{3s+10}{(s+3)(s+4)} \\ \frac{1}{s+3} \end{bmatrix}$$

$$\text{And } \mathbf{C}\Phi(s)\mathbf{B} = [1 \ 0] \begin{bmatrix} \frac{3s+10}{(s+3)(s+4)} \\ \frac{1}{s+3} \end{bmatrix} = \frac{3s+10}{(s+3)(s+4)}$$

$$\text{Hence: } \mathbf{C}\Phi(s)\mathbf{B} = \frac{3s+10}{s^2+7s+12} = H(s)$$

10.3-8

$$H(s) = \mathbf{C}\Phi(s)\mathbf{B} + D$$

in Prob. 10.3-5 we have found  $\Phi(s)$ . And

$$\Phi(s)\mathbf{B} = \begin{bmatrix} \frac{1}{(s+1)(s+2)} & \frac{1}{(s+1)(s+2)} \\ \frac{-2}{(s+1)(s+2)} & \frac{1}{(s+1)(s+2)} \end{bmatrix} \begin{bmatrix} 1 \\ 0 \end{bmatrix} = \begin{bmatrix} \frac{1}{(s+1)(s+2)} \\ \frac{-2}{(s+1)(s+2)} \end{bmatrix}$$

Hence

$$\mathbf{C}\Phi(s)\mathbf{B} = [1 \ 0] \Phi(s)\mathbf{B} = \frac{-2}{(s+1)(s+2)} \quad \text{and since } D = 0$$

$$H(s) = \mathbf{C}\Phi(s)\mathbf{B} = \frac{-2}{s^2+3s+2}$$

10.3-9 From Prob. 10.3-6,

$$\Phi(s)\mathbf{B} = \begin{bmatrix} \frac{s+1}{(s+1)^2+1} & \frac{1}{(s+1)^2+1} \\ \frac{-1}{(s+1)^2+1} & \frac{s+1}{(s+1)^2+1} \end{bmatrix} \begin{bmatrix} 0 \\ 1 \end{bmatrix} = \begin{bmatrix} \frac{1}{(s+1)^2+1} \\ \frac{s+1}{(s+1)^2+1} \end{bmatrix}$$

And:

$$\mathbf{C}\Phi(s)\mathbf{B} = [1 \ 1] \begin{bmatrix} \frac{1}{(s+1)^2+1} \\ \frac{s+1}{(s+1)^2+1} \end{bmatrix} = \frac{s+1+1}{(s+1)^2+1} = \frac{s+2}{(s+1)^2+1}$$

And

$$H(s) = \mathbf{C}\Phi(s)\mathbf{B} + D = \frac{s+2}{(s+1)^2+1} + 1 = \frac{s^2+3s+4}{s^2+2s+2}$$

10.3-10 In this case:

$$s\mathbf{I} - \mathbf{A} = \begin{bmatrix} s & -1 \\ 1 & s+2 \end{bmatrix} \quad \text{and } \Phi(s) = (s\mathbf{I} - \mathbf{A})^{-1} = \frac{1}{(s+1)^2} \begin{bmatrix} s+2 & 1 \\ -1 & s \end{bmatrix}$$

$$= \begin{bmatrix} \frac{s+2}{(s+1)^2} & \frac{1}{(s+1)^2} \\ \frac{-1}{(s+1)^2} & \frac{s}{(s+1)^2} \end{bmatrix}$$

And:

$$\Phi(s)\mathbf{B} = \begin{bmatrix} \frac{s+2}{(s+1)^2} & \frac{1}{(s+1)^2} \\ \frac{-1}{(s+1)^2} & \frac{s}{(s+1)^2} \end{bmatrix} \begin{bmatrix} 0 & 1 \\ 1 & 0 \end{bmatrix} = \begin{bmatrix} \frac{1}{(s+1)^2} & \frac{s+2}{(s+1)^2} \\ \frac{s}{(s+1)^2} & \frac{-1}{(s+1)^2} \end{bmatrix}$$

$$\mathbf{C}\Phi(s)\mathbf{B} = \begin{bmatrix} 1 & 2 \\ 4 & 1 \\ 1 & 1 \end{bmatrix} \begin{bmatrix} \frac{1}{(s+1)^2} & \frac{s+2}{(s+1)^2} \\ \frac{s}{(s+1)^2} & \frac{-1}{(s+1)^2} \end{bmatrix}$$

$$\text{and } H(s) = \mathbf{C}\Phi(s)\mathbf{B} + D = \begin{bmatrix} \frac{2s+1}{(s+1)^2} & \frac{s}{(s+1)^2} \\ \frac{4s+4}{(s+1)^2} & \frac{4s+1}{(s+1)^2} \\ \frac{1}{s+1} & \frac{1}{s+1} \end{bmatrix}$$

10.3-11 In the time domain, the solution  $x(t)$  is given by:

$$x(t) = e^{At}x(0) + \int_0^t e^{A(t-\tau)}Bf(\tau) d\tau$$

$$x(t) = e^{At}x(0) + e^{At} * Bf(t)$$

where:

$$e^{At} = \mathcal{L}^{-1}[(sI - A)^{-1}] = \mathcal{L}^{-1}(\Phi(s))$$

From Prob. 10.3-1 we have found:

$$\Phi(s) = \begin{bmatrix} \frac{s+3}{(s+1)(s+2)} & \frac{2}{(s+1)(s+2)} \\ \frac{-1}{(s+1)(s+2)} & \frac{2}{(s+1)(s+2)} \end{bmatrix} = \begin{bmatrix} \frac{2}{s+1} - \frac{1}{s+2} & \frac{2}{s+1} - \frac{2}{s+2} \\ \frac{-1}{s+1} + \frac{1}{s+2} & \frac{-1}{s+1} + \frac{2}{s+2} \end{bmatrix}$$

$$e^{At} = \mathcal{L}^{-1}(\Phi(s)) = \begin{bmatrix} 2e^{-t} - e^{-2t} & 2e^{-t} - 2e^{-2t} \\ -e^{-t} + e^{-2t} & -e^{-t} + 2e^{-2t} \end{bmatrix}$$

$$e^{At}x(0) = \begin{bmatrix} 4e^{-t} - 2e^{-2t} + 2e^{-t} - 2e^{-2t} \\ -2e^{-t} + 2e^{-2t} - e^{-t} + 2e^{-2t} \end{bmatrix} = \begin{bmatrix} 6e^{-t} - 4e^{-2t} \\ -3e^{-t} + 4e^{-2t} \end{bmatrix}$$

Also:  $Bf(t) = \begin{bmatrix} 0 \\ 1 \end{bmatrix} \times 0 = 0$

hence:  $x(t) = \begin{bmatrix} (6e^{-t} - 4e^{-2t})u(t) \\ (-3e^{-t} + 4e^{-2t})u(t) \end{bmatrix}$

which is the same thing as in Prob. 10.3-1.

10.3-12 From Prob. 10.3-2,

$$\Phi(s) = \begin{bmatrix} \frac{s+3}{(s+2)(s+3)} & \frac{-4}{(s+2)(s+3)} \\ \frac{1}{(s+2)(s+3)} & \frac{s+5}{(s+2)(s+3)} \end{bmatrix} = \begin{bmatrix} \frac{-2}{s+2} + \frac{3}{s+3} & \frac{-6}{s+2} + \frac{6}{s+3} \\ \frac{1}{s+2} - \frac{1}{s+3} & \frac{3}{s+2} - \frac{2}{s+3} \end{bmatrix}$$

Hence:  $e^{At} = \mathcal{L}^{-1}(\Phi(s)) = \begin{bmatrix} -2e^{-2t} + 3e^{-3t} & -6e^{-2t} + 6e^{-3t} \\ e^{-2t} - e^{-3t} & 3e^{-2t} - 2e^{-3t} \end{bmatrix}$

And:

$$e^{At}x(0) = \begin{bmatrix} -10e^{-2t} + 15e^{-3t} - 24e^{-2t} + 24e^{-3t} \\ 5e^{-2t} - 5e^{-3t} + 12e^{-2t} - 8e^{-3t} \end{bmatrix} = \begin{bmatrix} -34e^{-2t} + 39e^{-3t} \\ 17e^{-2t} - 13e^{-3t} \end{bmatrix}$$

Also:  $Bf(t) = \begin{bmatrix} 1 \\ 0 \end{bmatrix} \sin 100t = \begin{bmatrix} \sin 100t \\ 0 \end{bmatrix}$

And  $e^{At} * Bf(t) = \begin{bmatrix} -2e^{-2t} * \sin 100t + 3e^{-3t} * \sin 100t \\ e^{-2t} * \sin 100t - e^{-3t} * \sin 100t \end{bmatrix}$

$$= \begin{bmatrix} -\frac{2e^{-2t}}{100} + \frac{2\cos 100t}{100} + \frac{3e^{-3t}}{100} - \frac{3\cos 100t}{100} \\ + \frac{e^{-2t}}{100} - \frac{\cos 100t}{100} - \frac{e^{-3t}}{100} + \frac{\cos 100t}{100} \end{bmatrix}$$

$$= \begin{bmatrix} -0.02e^{-2t} + 0.03e^{-3t} - 0.01 \cos 100t \\ 0.01e^{-2t} - 0.01e^{-3t} \end{bmatrix}$$

Hence:

$$x(t) = e^{At}[x(0)] + e^{At} * Bf(t) = \begin{bmatrix} -34.02e^{-2t} + 39e^{-3t} + 0.01 \cos 100t \\ 17.01e^{-2t} - 13.0e^{-3t} \end{bmatrix}$$

Hence

$$\mathbf{x}(t) = e^{\mathbf{A}t} \mathbf{x}(0) + e^{\mathbf{A}t} \cdot \mathbf{B}f = \begin{bmatrix} -34.02e^{-2t} + 39.03e^{-3t} + 0.01 \cos 100t \\ 17.01e^{-2t} - 13.01e^{-3t} \end{bmatrix}$$

This is the same result as in Prob. 10.3-2.

10.3-13 From Prob. 10.3-3,

$$\Phi(s) = \begin{bmatrix} \frac{1}{s+2} & 0 \\ \frac{1}{(s+1)(s+2)} & \frac{1}{s+1} \end{bmatrix} = \begin{bmatrix} \frac{1}{s+2} & 0 \\ \frac{1}{s+1} - \frac{1}{s+2} & \frac{1}{s+1} \end{bmatrix}$$

$$\text{Hence: } e^{\mathbf{A}t} = \mathcal{L}^{-1}(\Phi(s)) = \begin{bmatrix} e^{-2t} & 0 \\ e^{-t} - e^{-2t} & e^{-t} \end{bmatrix}$$

$$\text{And: } e^{\mathbf{A}t} \mathbf{x}(0) = \begin{bmatrix} e^{-2t} & 0 \\ e^{-t} - e^{-2t} & e^{-t} \end{bmatrix} \begin{bmatrix} 0 \\ -1 \end{bmatrix} = \begin{bmatrix} 0 \\ -e^{-t} \end{bmatrix}$$

$$\text{Also: } \mathbf{B}f(t) = \begin{bmatrix} 1 \\ 0 \end{bmatrix} u(t) = \begin{bmatrix} u(t) \\ 0 \end{bmatrix}$$

$$\text{And: } e^{\mathbf{A}t} \cdot \mathbf{B}f(t) = \begin{bmatrix} e^{-2t} \cdot u(t) \\ e^{-t} \cdot u(t) - e^{-2t} \cdot u(t) \end{bmatrix} = \begin{bmatrix} \frac{1}{2}(1 - e^{-2t})u(t) \\ (1 - e^{-t}) - \frac{1}{2}(1 - e^{-2t}) \end{bmatrix}$$

And hence:

$$\begin{aligned} \mathbf{x}(t) &= e^{\mathbf{A}t} \mathbf{x}(0) + e^{\mathbf{A}t} \cdot \mathbf{B}f(t) = \begin{bmatrix} 0 \\ -e^{-t} \end{bmatrix} + \begin{bmatrix} \frac{1}{2} - \frac{1}{2}e^{-2t} \\ \frac{1}{2} - e^{-t} + \frac{1}{2}e^{-2t} \end{bmatrix} \\ &= \begin{bmatrix} \frac{1}{2} - \frac{1}{2}e^{-2t} \\ \frac{1}{2} + \frac{1}{2}e^{-2t} - 2e^{-t} \end{bmatrix} \end{aligned}$$

10.3-14 From Prob. 10.3-4,

$$\Phi(s) = \begin{bmatrix} \frac{1}{s+1} & \frac{1}{(s+1)(s+2)} \\ 0 & \frac{1}{s+2} \end{bmatrix} = \begin{bmatrix} \frac{1}{s+1} & \frac{1}{s+1} - \frac{1}{s+2} \\ 0 & \frac{1}{s+2} \end{bmatrix}$$

$$\text{Hence: } e^{\mathbf{A}t} = \mathcal{L}^{-1}(\Phi(s)) = \begin{bmatrix} e^{-t} & e^{-t} - e^{-2t} \\ 0 & e^{-2t} \end{bmatrix}$$

$$e^{\mathbf{A}t} \mathbf{x}(0) = \begin{bmatrix} e^{-t} & e^{-t} - e^{-2t} \\ 0 & e^{-2t} \end{bmatrix} \begin{bmatrix} 1 \\ 2 \end{bmatrix} = \begin{bmatrix} 3e^{-t} - 2e^{-2t} \\ 2e^{-2t} \end{bmatrix}$$

$$\mathbf{B}f(t) = \begin{bmatrix} 1 & 1 \\ 0 & 1 \end{bmatrix} \begin{bmatrix} u(t) \\ \delta(t) \end{bmatrix} = \begin{bmatrix} u(t) + \delta(t) \\ \delta(t) \end{bmatrix}$$

$$\text{And } e^{\mathbf{A}t} \cdot \mathbf{B}f(t) = \begin{bmatrix} e^{-t} \cdot u(t) + e^{-t} \cdot \delta(t) + e^{-t} \cdot \delta(t) - e^{-2t} \cdot \delta(t) \\ e^{-2t} \cdot \delta(t) \end{bmatrix}$$

$$e^{\mathbf{A}t} \cdot \mathbf{B}f(t) = \begin{bmatrix} (1 - e^{-t}) + e^{-t} + e^{-t} - e^{-2t} \\ e^{-2t} \end{bmatrix} \begin{bmatrix} 1 + e^{-t} - e^{-2t} \\ e^{-2t} \end{bmatrix}$$

$$\begin{aligned} \text{And hence: } \mathbf{x}(t) &= e^{\mathbf{A}t} \mathbf{x}(0) + e^{\mathbf{A}t} \cdot \mathbf{B}f(t) = \begin{bmatrix} 3e^{-t} - 2e^{-2t} + 1 + e^{-t} - e^{-2t} \\ 2e^{-2t} + e^{-2t} \end{bmatrix} \\ &= \begin{bmatrix} 1 + 4e^{-t} - 3e^{-2t} \\ 3e^{-2t} \end{bmatrix} \end{aligned}$$

10.3-15 From Prob. 10.3-5,

$$\Phi(s) = \begin{bmatrix} \frac{1}{(s+1)(s+2)} & \frac{1}{(s+1)(s+2)} \\ \frac{-2}{(s+1)(s+2)} & \frac{1}{(s+1)(s+2)} \end{bmatrix} = \begin{bmatrix} \frac{-1}{s+1} + \frac{2}{s+2} & \frac{1}{s+1} - \frac{1}{s+2} \\ \frac{-2}{s+1} + \frac{2}{s+2} & \frac{1}{s+1} - \frac{1}{s+2} \end{bmatrix}$$

And  $y(t)$  is given by:  $y(t) = C[e^{At}x(0) + e^{At}B * f(t)] + Df(t)$

$$\text{where: } e^{At} = \mathcal{L}^{-1}(\Phi(s)) = \begin{bmatrix} -e^{-t} + 2e^{-2t} & e^{-t} - e^{-2t} \\ -2e^{-t} + 2e^{-2t} & 2e^{-t} - e^{-2t} \end{bmatrix}$$

$$\text{And: } e^{At}x(0) = e^{At} \begin{bmatrix} 2 \\ 0 \end{bmatrix} = \begin{bmatrix} -2e^{-t} + 4e^{-2t} \\ -2e^{-t} + 4e^{-2t} \end{bmatrix}$$

$$e^{At}B = e^{At} \begin{bmatrix} 1 \\ 0 \end{bmatrix} = \begin{bmatrix} -e^{-t} + 2e^{-2t} \\ -2e^{-t} + 2e^{-2t} \end{bmatrix}$$

$$e^{At} * Bf(t) = \begin{bmatrix} -e^{-t} + 2e^{-2t} \\ -2e^{-t} + 2e^{-2t} \end{bmatrix} * u(t) = \begin{bmatrix} -e^{-t} * u(t) + e^{-2t} * u(t) \\ -2e^{-t} * u(t) + 2e^{-2t} * u(t) \end{bmatrix}$$

$$= \begin{bmatrix} e^{-t} - e^{-2t} \\ -1 + 2e^{-t} - e^{-2t} \end{bmatrix}$$

Since  $D = 0 \implies y(t) = C[e^{At}x(0) + e^{At} * Bf(t)]$

$$\text{And: } e^{At}x(0) + e^{At} * Bf(t) = \begin{bmatrix} -2e^{-t} + 4e^{-2t} \\ -4e^{-t} + 4e^{-2t} \end{bmatrix} + \begin{bmatrix} e^{-t} - e^{-2t} \\ -1 + 2e^{-t} - e^{-2t} \end{bmatrix}$$

$$= \begin{bmatrix} -e^{-t} + 3e^{-2t} \\ -1 - 2e^{-t} + 3e^{-2t} \end{bmatrix}$$

And hence:

$$y(t) = \begin{bmatrix} 0 & 1 \end{bmatrix} + \begin{bmatrix} -e^{-t} + 3e^{-2t} \\ -1 - 2e^{-t} + 3e^{-2t} \end{bmatrix} = (-1 - 2e^{-t} + 3e^{-2t})u(t)$$

10.3-16

$$y(t) = C[e^{At}x(0) + e^{At} * Bf(t)] + Df(t)$$

From Prob. 10.3-6 we have obtained:

$$\Phi(s) = \begin{bmatrix} \frac{s+1}{(s+1)^2+1} & \frac{1}{(s+1)^2+1} \\ \frac{-1}{(s+1)^2+1} & \frac{s+1}{(s+1)^2+1} \end{bmatrix}$$

$$\text{Hence: } e^{At} = \mathcal{L}^{-1}(\Phi(s)) = \begin{bmatrix} e^{-t} \cos t & e^{-t} \sin t \\ -e^{-t} \sin t & e^{-t} \cos t \end{bmatrix}$$

$$e^{At}x(0) = e^{At} \begin{bmatrix} 2 \\ 1 \end{bmatrix} = \begin{bmatrix} 2e^{-t} \cos t + e^{-t} \sin t \\ -2e^{-t} \sin t + e^{-t} \cos t \end{bmatrix}$$

$$\text{And: } e^{At}B = e^{At} \begin{bmatrix} 0 \\ 1 \end{bmatrix} = \begin{bmatrix} e^{-t} \sin t \\ e^{-t} \cos t \end{bmatrix}$$

$$\text{And: } e^{At} * Bf(t) = \begin{bmatrix} e^{-t} \sin t * u(t) \\ e^{-t} \cos t * u(t) \end{bmatrix} = \begin{bmatrix} \frac{\cos(\frac{\pi}{2} - \phi)}{\sqrt{2}} - \frac{e^{-t}}{\sqrt{2}} \cos(t - \frac{\pi}{2} - \phi) \\ \frac{\cos(-\phi)}{\sqrt{2}} - \frac{e^{-t}}{\sqrt{2}} \cos(t - \phi) \end{bmatrix}$$

where:  $\phi = \tan^{-1} \frac{-1}{1} = -\frac{\pi}{4}$ . And hence:

$$e^{At}x(0) + e^{At} * Bf(t) = \begin{bmatrix} \frac{1}{2} + \frac{3}{2}e^{-t} \cos t + \frac{1}{2}e^{-t} \sin t \\ \frac{1}{2} + \frac{1}{2}e^{-t} \cos t - \frac{3}{2}e^{-t} \sin t \end{bmatrix}$$

And

$$\begin{aligned} y(t) &= C[e^{\Lambda t}x(0) + e^{\Lambda t} * Bf(t)] + Df(t) \\ &= [1 \quad 1][e^{\Lambda t}x(0) + e^{\Lambda t} * Bf(t)] + u(t) \\ &= [1 + 2e^{-t} \cos t - e^{-t} \sin t + 1]u(t) = [2 + 2e^{-t} \cos t - e^{-t} \sin t]u(t) \end{aligned}$$

10.3-17

$$H(s) = \frac{3s + 10}{s^2 + 7s + 12}$$

From Eq. (10.65) we have:

$$h(t) = C\phi(t)B + D\delta(t) \quad \text{where} \quad \phi(t) = e^{\Lambda t}$$

From Prob. 10.3-7 we obtained  $\Phi(s)$  as:

$$\Phi(s) = \begin{bmatrix} \frac{1}{s+1} & \frac{1}{(s+3)(s+4)} \\ 0 & \frac{1}{s+1} \end{bmatrix} \quad B = \begin{bmatrix} 3 \\ 1 \end{bmatrix} \quad C = [1 \quad 0] \quad \text{and} \quad D = 0$$

$$\text{hence:} \quad e^{\Lambda t} = \mathcal{L}^{-1}(\Phi(s)) = \begin{bmatrix} e^{-4t} & e^{-3t} - e^{-4t} \\ 0 & e^{-3t} \end{bmatrix}$$

$$\text{And:} \quad \phi(t)B = \begin{bmatrix} 3e^{-4t} + e^{-3t} - e^{-4t} \\ e^{-3t} \end{bmatrix} = \begin{bmatrix} e^{-3t} + 2e^{-4t} \\ e^{-3t} \end{bmatrix}$$

$$\begin{aligned} \text{Since} \quad D = 0, \quad h(t) &= C\phi(t)B = [1 \quad 0]\phi(t)B \\ &= (e^{-3t} + 2e^{-4t})u(t) \end{aligned}$$

10.3-18 From Prob. 10.3-6,

$$\Phi(s) = \begin{bmatrix} \frac{s+1}{(s+1)^2+1} & \frac{1}{(s+1)^2+1} \\ \frac{-1}{(s+1)^2+1} & \frac{s+1}{(s+1)^2+1} \end{bmatrix}$$

$$\text{hence:} \quad \phi(t) = \mathcal{L}^{-1}(\Phi(s)) = \begin{bmatrix} e^{-t} \cos t & e^{-t} \sin t \\ -e^{-t} \sin t & e^{-t} \cos t \end{bmatrix}$$

$$\phi(t)B = \phi(t) \begin{bmatrix} 0 \\ 1 \end{bmatrix} = \begin{bmatrix} e^{-t} \sin t \\ e^{-t} \cos t \end{bmatrix}$$

$$\text{And:} \quad C\phi(t)B = [1 \quad 1]\phi(t)B = (e^{-t} \sin t + e^{-t} \cos t)$$

And

$$h(t) = C\phi(t)B + \delta(t) = \delta(t) + (e^{-t} \sin t + e^{-t} \cos t)u(t)$$

10.3-19 From Prob. 10.3-10,

$$\phi(s) = \begin{bmatrix} \frac{2s+1}{(s+1)^2} & \frac{1}{(s+1)^2} \\ \frac{4s+6}{(s+1)^2} & \frac{4s+7}{(s+1)^2} \\ \frac{s+2}{s+1} & \frac{1}{s+1} \end{bmatrix} = \begin{bmatrix} \frac{2}{s+1} - \frac{1}{(s+1)^2} & \frac{1}{s+1} - \frac{1}{(s+1)^2} \\ \frac{1}{s+1} + \frac{3}{(s+1)^2} & \frac{4}{s+1} + \frac{3}{(s+1)^2} \\ 1 + \frac{1}{s+1} & \frac{1}{s+1} \end{bmatrix}$$

And hence: the unit inputs response  $h(t)$  is given by:

$$h(t) = \mathcal{L}^{-1}\{H(s)\} = \begin{bmatrix} 2e^{-t} - te^{-t} & e^{-t} - te^{-t} \\ e^{-t} + 3te^{-t} & 4e^{-t} + 3te^{-t} \\ \delta(t) + e^{-t} & e^{-t} \end{bmatrix}$$

10.4-1

$$\begin{bmatrix} \dot{x}_1 \\ \dot{x}_2 \end{bmatrix} = \begin{bmatrix} 0 & 1 \\ -1 & -1 \end{bmatrix} \begin{bmatrix} x_1 \\ x_2 \end{bmatrix} + \begin{bmatrix} 2 \\ 1 \end{bmatrix} f$$

$$w = \begin{bmatrix} 0 & 1 \\ -1 & 1 \end{bmatrix} \begin{bmatrix} x_1 \\ x_2 \end{bmatrix} = Px$$

The new state equation of the system is given by:

$$\dot{w} = PAP^{-1}w + PB = \hat{A}w + \hat{B}f$$

$$P^{-1} = \begin{bmatrix} 1 & -1 \\ 1 & 0 \end{bmatrix} \Rightarrow PA = \begin{bmatrix} 0 & 1 \\ -1 & 1 \end{bmatrix} \begin{bmatrix} 0 & 1 \\ -1 & -1 \end{bmatrix} = \begin{bmatrix} -1 & -1 \\ -1 & -2 \end{bmatrix}$$

$$PAP^{-1} = \begin{bmatrix} -1 & -1 \\ -1 & -2 \end{bmatrix} \begin{bmatrix} 1 & -1 \\ 1 & 0 \end{bmatrix} = \begin{bmatrix} -2 & 1 \\ -3 & 1 \end{bmatrix}$$

$$\text{And: } PB = \begin{bmatrix} 0 & 1 \\ -1 & 1 \end{bmatrix} \begin{bmatrix} 2 \\ 1 \end{bmatrix} = \begin{bmatrix} 1 \\ -1 \end{bmatrix} f$$

$$\text{Hence } \begin{bmatrix} \dot{w}_1 \\ \dot{w}_2 \end{bmatrix} = \begin{bmatrix} -2 & 1 \\ -3 & 1 \end{bmatrix} \begin{bmatrix} w_1 \\ w_2 \end{bmatrix} + \begin{bmatrix} 1 \\ -1 \end{bmatrix} f$$

Eigenvalues in the original system:

The eigenvalues are the roots of the characteristic equation, thus: in the original system:

$$|sI - A| = \begin{vmatrix} s & -1 \\ 1 & s+1 \end{vmatrix} = (s+1)s + 1 = s^2 + s + 1 = 0$$

$$\text{The roots are given by: } s_{1,2} = \frac{-1 \pm j\sqrt{3}}{2}$$

In the transformed system, the characteristic equation is given by:

$$|sI - \hat{A}| = \begin{vmatrix} s+2 & -1 \\ 3 & s-1 \end{vmatrix} = (s+2)(s-1) + 3 = s^2 - s + 2s - 2 + 3 = s^2 + s + 1$$

And the eigenvalues are given by:

$$s_{1,2} = \frac{-1 \pm j\sqrt{3}}{2}$$

which are the same as in the original system.

10.4-2

$$\begin{bmatrix} \dot{x}_1 \\ \dot{x}_2 \end{bmatrix} = \begin{bmatrix} 0 & 1 \\ -2 & -3 \end{bmatrix} \begin{bmatrix} x_1 \\ x_2 \end{bmatrix} + \begin{bmatrix} 0 \\ 2 \end{bmatrix} f(t)$$

(a) The characteristic equation is given by:

$$|sI - A| = 0 = \begin{vmatrix} s & -1 \\ 2 & s+3 \end{vmatrix} = s(s+3) - 2 = s^2 + 3s + 2 = (s+1)(s+2) = 0$$

$\lambda_1 = -1$  and  $\lambda_2 = -2$  are the eigenvalues. And

$$A = \begin{bmatrix} -1 & 0 \\ 0 & -2 \end{bmatrix}$$

$w = Px$  and  $\dot{w} = PAP^{-1}w + PBf = \hat{A}w + \hat{B}f$

Hence we have to find  $P$  such that:  $PAP^{-1} = \hat{A}$  or  $AP = \hat{A}P$

$$\begin{bmatrix} -1 & 0 \\ 0 & -2 \end{bmatrix} \begin{bmatrix} p_{11} & p_{12} \\ p_{21} & p_{22} \end{bmatrix} = \begin{bmatrix} p_{11} & p_{12} \\ p_{21} & p_{22} \end{bmatrix} \begin{bmatrix} 0 & 1 \\ -2 & -3 \end{bmatrix}$$



$$\left. \begin{aligned} -p_{11} &= 2p_{12} \implies p_{11} = 2p_{12} \\ p_{12} &= 3p_{12} - p_{11} \\ p_{21} &= p_{22} \\ p_{22} &= 3p_{22} - p_{21} \end{aligned} \right\} \implies \begin{aligned} p_{12} &= 3p_{12} - 2p_{12} \\ \text{If we choose } p_{11} &= 2 \text{ then } p_{12} = 1 \\ \text{And if } p_{21} &= 1 \text{ then } p_{22} = 1 \end{aligned}$$

Therefore 
$$P = \begin{bmatrix} 2 & 1 \\ 1 & 1 \end{bmatrix}$$

and hence 
$$w = \begin{bmatrix} w_1 \\ w_2 \end{bmatrix} = \begin{bmatrix} 2 & 1 \\ 1 & 1 \end{bmatrix} \begin{bmatrix} x_1 \\ x_2 \end{bmatrix} = \begin{bmatrix} 2x_1 + x_2 \\ x_1 + x_2 \end{bmatrix}$$

(b)  $y = Cx + Df$  where  $D = 0 \implies y = Cx$ .  
we have  $w = Px \implies P^{-1}w = x \implies y = CP^{-1}w$ . hence:

$$P^{-1} = \begin{bmatrix} 1 & -1 \\ -1 & 2 \end{bmatrix}, \quad CP^{-1} = \begin{bmatrix} 1 & 1 \\ -1 & 2 \end{bmatrix} \begin{bmatrix} 1 & -1 \\ -1 & 2 \end{bmatrix} = \begin{bmatrix} 0 & 1 \\ -3 & 5 \end{bmatrix}$$

$$y = \begin{bmatrix} 0 & 1 \\ -3 & 5 \end{bmatrix} \begin{bmatrix} w_1 \\ w_2 \end{bmatrix} = \begin{bmatrix} w_2 \\ 5w_2 - 3w_1 \end{bmatrix}$$

10.4-3

$$\dot{x} = \begin{bmatrix} 0 & 1 & 0 \\ 0 & 0 & 1 \\ 0 & -2 & -3 \end{bmatrix} x + \begin{bmatrix} 0 \\ 0 \\ 1 \end{bmatrix} f$$

The characteristic equation is given by:

$$|sI - A| = \begin{vmatrix} s & -1 & 0 \\ 0 & s & -1 \\ 0 & 2 & s+3 \end{vmatrix}$$

$$= s\{(s)(s+3) + 2\} = s(s^2 + 3s + 2) = s(s+1)(s+2) = 0$$

Hence the eigenvalues are:  $\lambda_1 = 0$ ,  $\lambda_2 = -1$  and  $\lambda_3 = -2$ . And

$$\Lambda = \begin{bmatrix} 0 & 0 & 0 \\ 0 & -1 & 0 \\ 0 & 0 & -2 \end{bmatrix}$$

In the transformed system we have:  $w = Px$  and  $\dot{w} = PAP^{-1}w + PBf$   
We have to find  $P$  such that:  $PAP^{-1} = \Lambda$  or  $AP = PA$ .

$$\begin{bmatrix} 0 & 0 & 0 \\ 0 & -1 & 0 \\ 0 & 0 & -2 \end{bmatrix} \begin{bmatrix} p_{11} & p_{12} & p_{13} \\ p_{21} & p_{22} & p_{23} \\ p_{31} & p_{32} & p_{33} \end{bmatrix} = \begin{bmatrix} p_{11} & p_{12} & p_{13} \\ p_{21} & p_{22} & p_{23} \\ p_{31} & p_{32} & p_{33} \end{bmatrix} \begin{bmatrix} 0 & 1 & 0 \\ 0 & 0 & 1 \\ 0 & -2 & -3 \end{bmatrix}$$

$$\implies \begin{cases} p_{21} = 0 & p_{31} = 0 & \text{if } p_{11} = 2 \text{ then } p_{13} = 1 \text{ and } p_{12} = 3 \\ p_{11} = p_{13} \\ p_{12} = 3p_{13} \\ p_{22} = 2p_{23} - p_{21} & \text{if } p_{23} = 1, \text{ then } p_{22} = 2 \text{ and } p_{23} = 1 \\ p_{23} = 3p_{23} - p_{22} & \text{if } p_{32} = 1 \text{ then } p_{33} = 1 \\ 2p_{32} = 2p_{33} - p_{31} \\ 2p_{33} = 3p_{33} - p_{32} \implies p_{33} = p_{32} \end{cases}$$

$$w = Px = \begin{bmatrix} 2 & 3 & 1 \\ 0 & 2 & 1 \\ 0 & 1 & 1 \end{bmatrix} \begin{bmatrix} x_1 \\ x_2 \\ x_3 \end{bmatrix} = \begin{bmatrix} w_1 \\ w_2 \\ w_3 \end{bmatrix}$$

10.4-4

$$y(t) = C[e^{At}x(0) + e^{At} \cdot Bf(t)]$$

where:  $e^{At} = \mathcal{L}^{-1}(\phi(s))$

$$(\phi(s))^{-1} = [sI - A] = \begin{bmatrix} s+1 & 0 & 0 \\ 0 & s+3 & 0 \\ 0 & 0 & s+2 \end{bmatrix}$$

$$\phi(s) = (sI - A)^{-1} = \begin{bmatrix} \frac{1}{s+1} & 0 & 0 \\ 0 & \frac{1}{s+3} & 0 \\ 0 & 0 & \frac{1}{s+2} \end{bmatrix} \text{ and } e^{At} = \begin{bmatrix} e^{-t} & 0 & 0 \\ 0 & e^{-3t} & 0 \\ 0 & 0 & e^{-2t} \end{bmatrix}$$

And:  $e^{At}x(0) = e^{At} \begin{bmatrix} 1 \\ 2 \\ 1 \end{bmatrix} = \begin{bmatrix} e^{-t} \\ 2e^{-3t} \\ e^{-2t} \end{bmatrix}$

$$e^{At}B = e^{At} \begin{bmatrix} 1 \\ 1 \\ 1 \end{bmatrix} = \begin{bmatrix} e^{-t} \\ e^{-3t} \\ e^{-2t} \end{bmatrix}$$

and:  $e^{At} \cdot Bf(t) = e^{At} \cdot Bu(t) = \begin{bmatrix} e^{-t} \cdot u(t) \\ e^{-3t} \cdot u(t) \\ e^{-2t} \cdot u(t) \end{bmatrix} = \begin{bmatrix} (1 - e^{-t})u(t) \\ \frac{1}{2}(1 - e^{-3t})u(t) \\ \frac{1}{2}(1 - e^{-2t})u(t) \end{bmatrix}$

Hence:  $e^{At}x(0) + e^{At} \cdot Bf(t) = \begin{bmatrix} e^{-t} + 1 - e^{-t} \\ 2e^{-3t} + \frac{1}{2} - \frac{1}{2}e^{-3t} \\ e^{-2t} + \frac{1}{2} - \frac{1}{2}e^{-2t} \end{bmatrix} = \begin{bmatrix} 1 \\ \frac{1}{2} + \frac{3}{2}e^{-3t} \\ \frac{1}{2} + \frac{1}{2}e^{-2t} \end{bmatrix}$

And finally:  $y(t) = C[e^{At}x(0) + e^{At} \cdot Bf(t)]$  with  $C = [1 \ 3 \ 1]$

$$y(t) = \left(1 + 1 + 3e^{-3t} + \frac{1}{2} + \frac{1}{2}e^{-2t}\right) = \left(\frac{5}{2} + \frac{1}{2}e^{-2t} + 3e^{-3t}\right)$$

10.5-1 (a) state equations:

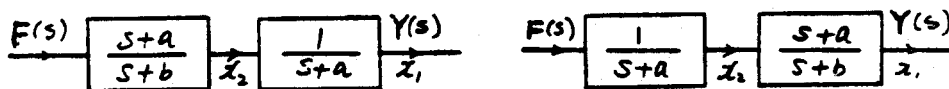

Fig. S10.5-1a and b

$$\dot{x}_2 + bx_2 = (a-b)f \implies \dot{x}_2 = -bx_2 + (a-b)f$$

$$\dot{x}_1 + ax_1 = x_2 + f \implies \dot{x}_1 = -ax_1 + x_2 + f$$

$$\begin{bmatrix} \dot{x}_1 \\ \dot{x}_2 \end{bmatrix} = \begin{bmatrix} -a & 1 \\ 0 & -b \end{bmatrix} \begin{bmatrix} x_1 \\ x_2 \end{bmatrix} + \begin{bmatrix} 1 \\ (a-b) \end{bmatrix} f$$

the output is:  $y = z_1 = \begin{bmatrix} 1 & 0 \end{bmatrix} \begin{bmatrix} x_1 \\ x_2 \end{bmatrix}$

The characteristic equation is

$$|sI - A| = 0 = \begin{vmatrix} s+a & -1 \\ 0 & s+b \end{vmatrix} = (s+a)(s+b) = 0$$

$\lambda_1 = -a$  and  $\lambda_2 = -b$  are the eigenvalues.

$$\Lambda = \begin{bmatrix} -a & 0 \\ 0 & -b \end{bmatrix}$$

we also have:  $w = Px$  and  $\dot{w} = PAP^{-1}w + PBf$ .

We are looking for  $P$  such that:  $PAP^{-1} = \Lambda$  or  $AP = PA$

$$\begin{bmatrix} -a & 0 \\ 0 & -b \end{bmatrix} \begin{bmatrix} p_{11} & p_{12} \\ p_{21} & p_{22} \end{bmatrix} = \begin{bmatrix} p_{11} & p_{12} \\ p_{21} & p_{22} \end{bmatrix} \begin{bmatrix} -a & 1 \\ 0 & -b \end{bmatrix}$$

$$\Rightarrow \begin{cases} -ap_{11} = -ap_{11} & \text{If } p_{11} = (b-a) \text{ then } p_{12} = 1 \\ -bp_{21} = -ap_{21} \Rightarrow p_{21} = 0 & p_{21} = 0 \text{ and } p_{22} \\ -ap_{12} = p_{11} - bp_{12} = 0 & \text{can be anything; let's take } p_{22} = 1 \\ -bp_{22} = p_{21} - bp_{22} \Rightarrow p_{21} = 0 \end{cases}$$

$$\text{And thus: } w = Px = \begin{bmatrix} b-a & 1 \\ 0 & 1 \end{bmatrix} \begin{bmatrix} x_1 \\ x_2 \end{bmatrix}$$

Observability: the output in terms of  $w$  is:  $y = Cx = CP^{-1}w = \hat{C}w$ .

$$\text{where: } P^{-1} = \frac{1}{b-a} \begin{bmatrix} 1 & -1 \\ 0 & b-a \end{bmatrix} = \begin{bmatrix} \frac{1}{b-a} & \frac{-1}{b-a} \\ 0 & 1 \end{bmatrix}$$

$$\text{hence: } \hat{C} = CP^{-1} = \begin{bmatrix} 1 & 0 \end{bmatrix} \begin{bmatrix} \frac{1}{b-a} & \frac{-1}{b-a} \\ 0 & 1 \end{bmatrix} = \begin{bmatrix} \frac{1}{b-a} & \frac{-1}{b-a} \end{bmatrix}$$

We notice that in  $\hat{C}$ , there is no column with all elements zeros, hence we conclude that the system is observable.

Controllability: In the new system (diagonalized form):

$$\hat{B} = PB = \begin{bmatrix} b-a & 1 \\ 0 & 1 \end{bmatrix} \begin{bmatrix} 1 \\ a-b \end{bmatrix} = \begin{bmatrix} 0 \\ a-b \end{bmatrix}$$

the 1st row in  $\hat{B}$  is zero. We affirm that this system is not controllable.

(b) State equations:

$$\begin{bmatrix} \dot{x}_1 \\ \dot{x}_2 \end{bmatrix} = \begin{bmatrix} -b & 0 \\ 0 & -a \end{bmatrix} \begin{bmatrix} x_1 \\ x_2 \end{bmatrix} + \begin{bmatrix} 1 \\ 1 \end{bmatrix} f$$

$$\text{and: } y = z_1 = \begin{bmatrix} 1 & 0 \end{bmatrix} \begin{bmatrix} x_1 \\ x_2 \end{bmatrix}$$

The matrix  $A$  is already in the diagonal form:

$$P = A = \begin{bmatrix} -b & 0 \\ 0 & -a \end{bmatrix} \Rightarrow P^{-1} = \frac{1}{ab} = \begin{bmatrix} -a & 0 \\ 0 & -b \end{bmatrix} = \begin{bmatrix} -\frac{1}{b} & 0 \\ 0 & -\frac{1}{a} \end{bmatrix}$$

In the transformed system:  $\dot{w} = PAP^{-1}w + PBf = Aw + \hat{B}f$ .

Observability:

$$\hat{C} = CP^{-1} = \begin{bmatrix} 1 & 0 \end{bmatrix} \begin{bmatrix} -\frac{1}{b} & 0 \\ 0 & -\frac{1}{a} \end{bmatrix} = \begin{bmatrix} -\frac{1}{b} & 0 \end{bmatrix}$$

the second column in  $\hat{C}$  vanishes. This system is not observable.

Controllability:

$$\hat{B} = PB = \begin{bmatrix} -b & 0 \\ 0 & -a \end{bmatrix} \begin{bmatrix} 1 & 1 \end{bmatrix} = \begin{bmatrix} -b & -a \end{bmatrix}$$

in  $\hat{B}$ , there is no row with all elements zero; hence this system is controllable.

10.6-1 (a) Time-domain method: the output  $y[k]$  is given by:

$$y[k] = CA^k x[0] + CA^{k-1} u[k-1] + Bf[k] + Df[k]$$

The characteristic equation of  $A$  is:

$$|\lambda I - A| = \begin{vmatrix} \lambda - 2 & 0 \\ -1 & \lambda - 1 \end{vmatrix} = (\lambda - 1)(\lambda - 2) = 0$$

$\lambda_1 = 1$  and  $\lambda_2 = 2$  are the eigenvalues of  $A$ . Also:

$$A^k = \beta_0 I + \beta_1 A \quad \text{where:} \quad \begin{bmatrix} \beta_0 \\ \beta_1 \end{bmatrix} = \begin{bmatrix} 1 & 1 \\ 1 & 2 \end{bmatrix}^{-1} \begin{bmatrix} 1 \\ 2^k \end{bmatrix}$$

$$\begin{bmatrix} \beta_0 \\ \beta_1 \end{bmatrix} = \begin{bmatrix} 2 & -1 \\ -1 & 1 \end{bmatrix} \begin{bmatrix} 1 \\ 2^k \end{bmatrix} = \begin{bmatrix} 2 - 2^k \\ -1 + 2^k \end{bmatrix}$$

hence:

$$A^k = \begin{bmatrix} \beta_0 & 0 \\ 0 & \beta_0 \end{bmatrix} + \begin{bmatrix} 2\beta_1 & 0 \\ \beta_1 & \beta_1 \end{bmatrix} = \begin{bmatrix} 2^k & 0 \\ 2^k - 1 & 1 \end{bmatrix}$$

$$\text{Hence:} \quad CA^k = [0 \ 1] A^k = [2^k - 1 \ 1]$$

And:

$$y_r[k] = CA^k x(0) = CA^k \begin{bmatrix} 2 \\ 1 \end{bmatrix} = (2^{k+1} - 1)u[k]$$

The zero-state component is given by:

$$y_f[k] = CA^{k-1} u[k-1] + Bf[k] + Df[k]$$

But

$$CA^k u[k] + Bf[k] = [2^k - 1 \ 1] u[k] + \begin{bmatrix} 0 \\ u[k] \end{bmatrix} = (k+1)u[k]$$

Hence

$$y_f[k] = ku[k-1] + Df[k] = ku[k-1] + u[k] = (k+1)u[k]$$

$$\text{and} \quad y[k] = y_r[k] + y_f[k] = [2^{k+1} + k]u[k]$$

(b) Frequency-domain method: in this case:

$$Y(z) = C(I - z^{-1}A)^{-1}x[0] + [C(zI - A)^{-1}B + D]F(z)$$

$$\begin{aligned} (I - z^{-1}A)^{-1} &= \begin{bmatrix} 1 - 2z^{-1} & 0 \\ -z^{-1} & 1 - z^{-1} \end{bmatrix}^{-1} = \begin{bmatrix} 1 - \frac{2}{z} & 0 \\ -\frac{1}{z} & 1 - \frac{1}{z} \end{bmatrix}^{-1} = \begin{bmatrix} \frac{z-2}{z} & 0 \\ -\frac{1}{z} & \frac{z-1}{z} \end{bmatrix}^{-1} \\ &= \frac{z^2}{(z-1)(z-2)} \begin{bmatrix} \frac{z-1}{z} & 0 \\ \frac{1}{z} & \frac{z-2}{z} \end{bmatrix} = \begin{bmatrix} \frac{1}{z-2} & 0 \\ \frac{z}{(z-1)(z-2)} & \frac{z}{z-1} \end{bmatrix} \end{aligned}$$

Also:

$$(zI - A)^{-1} = \begin{bmatrix} z-2 & 0 \\ -1 & z-1 \end{bmatrix}^{-1} = \frac{1}{(z-1)(z-2)} \begin{bmatrix} z-1 & 0 \\ 1 & z-2 \end{bmatrix}$$

$$= \begin{bmatrix} \frac{1}{z-2} & 0 \\ \frac{1}{(z-1)(z-2)} & \frac{1}{z-1} \end{bmatrix}$$

$$\text{and } C(I - z^{-1}A)^{-1} = \left[ \frac{1}{(z-1)(z-2)} \quad \frac{1}{z-1} \right]$$

$$C(I - z^{-1}A)^{-1}x(0) = \left[ \frac{2}{(z-1)(z-2)} + \frac{1}{z-1} \right] = \frac{z^2}{(z-1)(z-2)}$$

Also

$$C(zI - A)^{-1} = \left[ \frac{1}{(z-1)(z-2)} \quad \frac{1}{z-1} \right] \quad \text{and} \quad C(zI - A)^{-1}B = \frac{1}{z-1}$$

$$\text{Hence: } C(zI - A)^{-1}B + D = \frac{1}{z-1} + D = \frac{1}{z-1} + 1 = \frac{z}{z-1}$$

$$f[k] = u[k] \quad \text{and} \quad F(z) = \frac{z}{z-1}$$

$$\text{And hence: } (C(zI - A)^{-1}B + D)F(z) = \left[ \frac{z}{z-1} \right]^2 = \frac{z^2}{(z-1)^2}$$

$$Y(z) = C(I - z^{-1}A)^{-1}x(0) + [C(zI - A)^{-1}B + D]F(z) = \frac{z^2}{(z-1)(z-2)} + \frac{z^2}{(z-1)^2}$$

$$\frac{Y(z)}{z} = \frac{1}{z-2} + \frac{z}{(z-1)^2} = \frac{2}{z-2} + \frac{1}{(z-1)^2}$$

$$Y(z) = \frac{2z}{z-2} + \frac{z}{(z-1)^2}$$

$$\text{and } y[k] = z^{-1}[Y(z)] = [2^k + 1]u[k] + (k+1)u[k]$$

$$= [2^{k+1} + k]u[k]$$

10.6-2

$$y[k] = \frac{E + 0.32}{E^2 + E + 0.16} f[k]$$

(a) In this case:

$$H(s) = \frac{Y(s)}{F(s)} = \frac{s + 0.32}{s^2 + s + 0.16}$$

$$= \frac{s + 0.32}{(s + 0.2)(s + 0.8)} = \frac{0.2}{s + 0.2} + \frac{0.8}{s + 0.8}$$

(b) State and output equations for the controller canonical form: using the output of each delay as a state variable we get:

$$s_1[k+1] = s_2[k]$$

$$s_2[k+1] = -0.16s_1[k] - s_2[k] + f[k]$$

First canonical form:

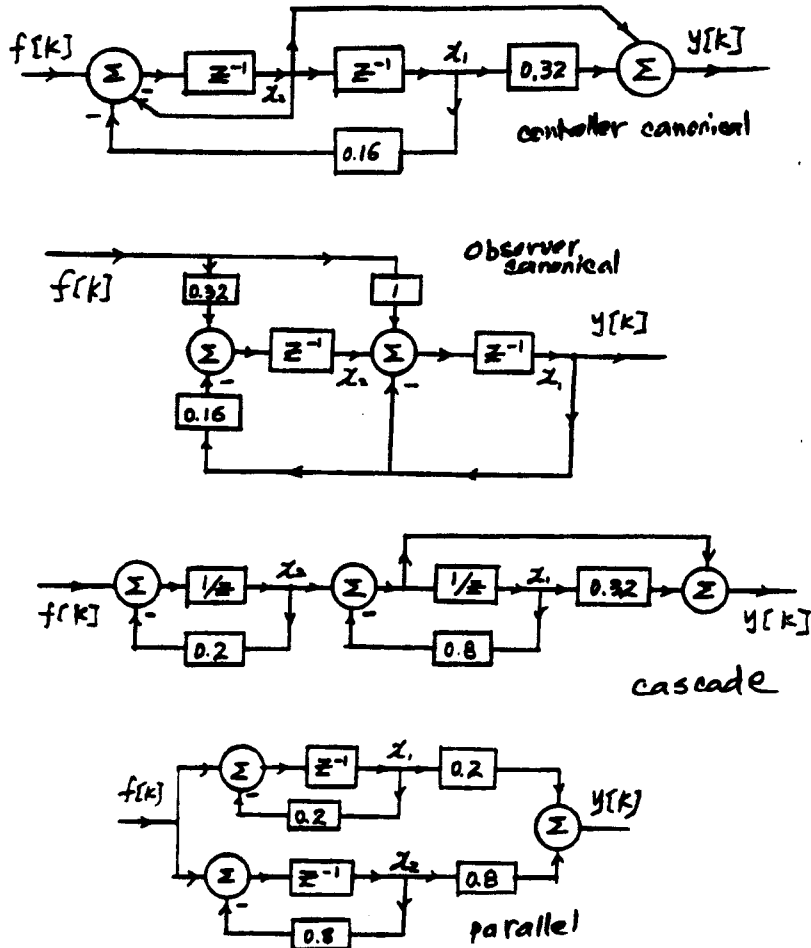

Figure S10.6-2

$$\begin{bmatrix} x_1[k+1] \\ x_2[k+1] \end{bmatrix} = \begin{bmatrix} 0 & 1 \\ -0.16 & -1 \end{bmatrix} \begin{bmatrix} x_1[k] \\ x_2[k] \end{bmatrix} + \begin{bmatrix} 0 \\ 1 \end{bmatrix} f[k]$$

output equation:

$$y[k] = 0.32x_1[k] + x_2[k] = \begin{bmatrix} 0.32 & 1 \end{bmatrix} \begin{bmatrix} x_1[k] \\ x_2[k] \end{bmatrix}$$

State equations for the observer canonical form:

$$x_1[k+1] = -x_1[k] + x_2[k] + f[k]$$

$$x_2[k+1] = -0.16x_1[k] + 0.32f[k]$$

$$\begin{bmatrix} x_1[k+1] \\ x_2[k+1] \end{bmatrix} = \begin{bmatrix} -1 & 1 \\ -0.16 & 0 \end{bmatrix} \begin{bmatrix} x_1[k] \\ x_2[k] \end{bmatrix} + \begin{bmatrix} 1 \\ 0.32 \end{bmatrix} f[k]$$

The output equation is:

$$y[k] = x_1[k] = \begin{bmatrix} 1 & 0 \end{bmatrix} \begin{bmatrix} x_1[k] \\ x_2[k] \end{bmatrix}$$

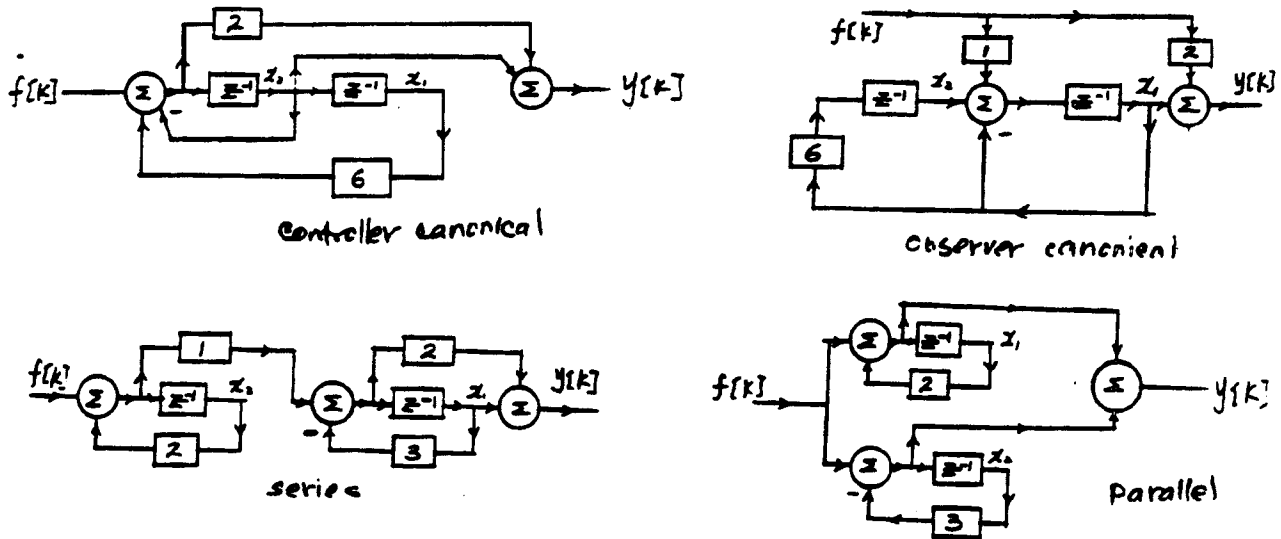

Figure S10.6-3

State equations for the cascade realization:

$$x_1[k+1] = -0.8x_1[k] + x_2[k]$$

$$x_2[k+1] = -0.2x_2[k] + f[k]$$

$$\begin{bmatrix} x_1[k+1] \\ x_2[k+1] \end{bmatrix} = \begin{bmatrix} -0.8 & 1 \\ 0 & -0.2 \end{bmatrix} \begin{bmatrix} x_1[k] \\ x_2[k] \end{bmatrix} + \begin{bmatrix} 0 \\ 1 \end{bmatrix} f[k]$$

The output equation is:

$$y[k] = 0.32x_1[k] - 0.8x_2[k] + x_2[k] = \begin{bmatrix} -0.48 & 1 \end{bmatrix} \begin{bmatrix} x_1[k] \\ x_2[k] \end{bmatrix}$$

State equations for the parallel realization:

$$x_1[k+1] = -0.2x_1[k] + f[k]$$

$$x_2[k+1] = -0.8x_2[k] + f[k]$$

$$\begin{bmatrix} x_1[k+1] \\ x_2[k+1] \end{bmatrix} = \begin{bmatrix} -0.2 & 0 \\ 0 & -0.8 \end{bmatrix} \begin{bmatrix} x_1[k] \\ x_2[k] \end{bmatrix} + \begin{bmatrix} 1 \\ 1 \end{bmatrix} f[k]$$

The output equation is:

$$y[k] = 0.2x_1[k] + 0.8x_2[k] = \begin{bmatrix} 0.2 & 0.8 \end{bmatrix} \begin{bmatrix} x_1[k] \\ x_2[k] \end{bmatrix}$$

10.6-3

$$y[k] = \frac{E(2E+1)}{E^2+E-6} f[k]$$

(a)

$$\begin{aligned} \frac{Y(z)}{F(z)} = H(z) &= \frac{z(2z+1)}{z^2+z-6} = \frac{2z^2+z}{z^2+z-6} \\ &= \frac{2z^2+z}{(z-2)(z+3)} = \left(\frac{z}{z-2}\right) \left(\frac{2z+1}{z+3}\right) \\ &= \frac{z}{z-2} + \frac{z}{z+3} \end{aligned}$$

(b) State and output equations for the controller canonical form:

$$x_1[k+1] = x_2[k]$$

$$x_2[k+1] = 6x_1[k] - x_2[k] + f[k]$$

and

$$\begin{bmatrix} x_1[k+1] \\ x_2[k+1] \end{bmatrix} = \begin{bmatrix} 0 & 1 \\ 6 & -1 \end{bmatrix} \begin{bmatrix} x_1[k] \\ x_2[k] \end{bmatrix} + \begin{bmatrix} 0 \\ 1 \end{bmatrix} f[k]$$

The output equation is:

$$\begin{aligned} y[k] &= x_2[k] + 2[6x_1[k] - x_2[k] + f[k]] \\ &= 12x_1[k] - 2x_2[k] + 2f[k] \end{aligned}$$

$$\text{Hence } y[k] = [12 \quad -2] \begin{bmatrix} x_1[k] \\ x_2[k] \end{bmatrix} + 2f[k]$$

State equations for the observer canonical form:

$$x_1[k+1] = -x_1[k] + x_2[k] + f[k]$$

$$x_2[k+1] = 6x_1[k]$$

$$\begin{bmatrix} x_1[k+1] \\ x_2[k+1] \end{bmatrix} = \begin{bmatrix} -1 & 1 \\ 6 & 0 \end{bmatrix} \begin{bmatrix} x_1[k] \\ x_2[k] \end{bmatrix} + \begin{bmatrix} 1 \\ 0 \end{bmatrix} f[k]$$

The output equation is:

$$y[k] = x_1[k] + 2f[k] = [1 \quad 0] \begin{bmatrix} x_1[k] \\ x_2[k] \end{bmatrix} + 2f[k]$$

State equations for the cascade realization:

$$x_1[k+1] = -0.3x_1[k] + 2x_2[k] + f[k]$$

$$x_2[k+1] = 2x_2[k] + f[k]$$

$$\begin{bmatrix} x_1[k+1] \\ x_2[k+1] \end{bmatrix} = \begin{bmatrix} -0.3 & 2 \\ 0 & 2 \end{bmatrix} \begin{bmatrix} x_1[k] \\ x_2[k] \end{bmatrix} + \begin{bmatrix} 1 \\ 1 \end{bmatrix} f[k]$$

The output equation is:

$$\begin{aligned} y[k] &= x_1[k] - 6x_1[k] + 4x_2[k] + 2f[k] \\ &= -5x_1[k] + 4x_2[k] + 2f[k] = [-5 \quad 4] \begin{bmatrix} x_1[k] \\ x_2[k] \end{bmatrix} + 2f[k] \end{aligned}$$

State equations for the parallel realization:

$$x_1[k+1] = 2x_1[k] + f[k]$$

$$x_2[k+1] = -3x_2[k] + f[k]$$

$$\begin{bmatrix} x_1[k+1] \\ x_2[k+1] \end{bmatrix} = \begin{bmatrix} 2 & 0 \\ 0 & -3 \end{bmatrix} \begin{bmatrix} x_1[k] \\ x_2[k] \end{bmatrix} + \begin{bmatrix} 1 \\ 1 \end{bmatrix} f[k]$$

The output equation is:

$$y[k] = 2x_1[k] + f[k] + f[k] - 3x_2[k]$$

$$y[k] = [2 \quad -3] \begin{bmatrix} x_1[k] \\ x_2[k] \end{bmatrix} + 2f[k]$$



