



# CDM

*Construction  
Design and  
Management*

---

**Worked Examples**



OCCUPATIONAL SAFETY & HEALTH COUNCIL



Environment, Transport and Works Bureau



Hong Kong Housing Authority

# CDM

*Construction  
Design and  
Management*

---

**Worked Examples**

**Disclaimer**

"The book is not for sale and is provided solely for reference purpose. The Environment, Transport and Works Bureau (ETWB), the Hong Kong Housing Authority (HKHA) and the Occupational Safety and Health Council (OSHC) are the owners of all copyright subsisting in this book. All unauthorized copying or reproduction in any means of this book or part of it is strictly prohibited.

ETWB, HKHA and OSHC make no warranty with respect to the accuracy and completeness of the contents of the book and should under no circumstances be held liable for providing such information."

# CONTENTS

---

## Introduction

<b>WORKED EXAMPLE NO. 1</b>	<b><i>Redevelopment of the Staff Quarters for the Establishment of a Rehabilitation Block at Tuen Mun Hospital - Phase 1</i></b> Architectural Services Department	1
<b>WORKED EXAMPLE NO. 2</b>	<b><i>Landslip Prevention Work to Slope No.15 NW-B/C66 at Upper Firing Range, Police Training School, Aberdeen</i></b> Geotechnical Engineering Office, Civil Engineering and Development Department	41
<b>WORKED EXAMPLE NO. 3</b>	<b><i>Rural Drainage Rehabilitation Scheme Stage 2, Phase 3 - Mo Fan Heung Stream Rehabilitation</i></b> Drainage Services Department	71
<b>WORKED EXAMPLE NO. 4</b>	<b><i>Widening of Tolo Highway and Fanling Highway - Traffic Control and Surveillance System</i></b> Electrical and Mechanical Services Department	95
<b>WORKED EXAMPLE NO. 5</b>	<b><i>Footbridge Across Po Kong Village Road at Junction with Tsz Wan Shan Road</i></b> Highways Department	119
<b>WORKED EXAMPLE NO. 6</b>	<b><i>Escalators for Footbridge at LRT/Road Junction of Lung Mun Road and Tuen Tsing Lane</i></b> Highways Department	141
<b>WORKED EXAMPLE NO. 7</b>	<b><i>Water Supply to Tai Long, Lantau Island</i></b> Water Supplies Department	163
<b>WORKED EXAMPLE NO. 8</b>	<b><i>Design Stage of a Proposed Public Housing Development Project</i></b> Housing Department	195

# I N T R O D

**T**he worked examples in this booklet are collected from a trial launch of CDM in 2003 in public works and public housing projects. The range of the projects participated in the trial was quite varied, including building, civil engineering and electrical and mechanical services projects from the Works group of Departments and HA. The worked examples were written by the project staff involved in those projects, which design stage fell within 2003 and 2004. The booklet would serve as a record about what was done by them in the trial, and their considerations and views about the CDM. Certain descriptions of the facts in the examples may have been overtaken by events by the time of the publishing of this booklet. However, this time lag should not affect the reader's appreciation of how CDM was applied to the projects. **The views expressed in the examples belong to their**

**project staff, and do not represent that of ETWB, HA or OSHC.**

The organization for the CDM trial in each department may be different, and in some case the differentiation of roles: project supervisor, designer etc. may not be distinct. This should not cause confusion to the reader, as the reader should concentrate more on the spirit of consideration on the risks, and their documentation, rather than the roles of individuals. The layout of each example follows generally the same format, which includes information about the project, list of hazards identified, and views about the CDM expressed by the project team. There is however no dictation on the style of presentation, nor the scope of information to be supplied. This can relieve the reader from the monotony of reading through these examples.

# U C T I O N

It should be noted that the examples in this booklet attempt to give an idea on how CDM was conducted in various projects and produced benefits. The reader should NOT attempt to deduce procedures and methodologies about CDM from the examples. Furthermore, the reader should be aware that the quality of examples may vary, as we have put together as many examples as we can obtain from our trial to enable the reader to appreciate as wide a range as possible of CDM activities carried out in some government departments. Standard procedures and methodology simply do not exist for CDM, as the nature of projects of each department (or organization) may vary, and each has its own culture.

It is hoped, therefore, through reading the examples of this booklet, the reader can gain some insight about what had been

done (rather than *what is required to be done*) in the CDM process, and therefore can gain the confidence to try out the system in their own projects. Only through first hand experience can the local construction industry form its judgment on the true value of the CDM system, identify its strengths and weaknesses, and decide on how the system can be improved, if it can ever be improved at all, to the benefit of the whole construction industry.

Whatever future holds for CDM in the local construction scene, if CDM can instill a sense of 'considerate' culture and have an impact on the corporate management philosophy more than just becoming another source of paper work, then CDM would fulfill its mission.

CDM

*WORKED EXAMPLE No. 1*

*Redevelopment of the Staff Quarters  
for the Establishment of a Rehabilitation  
Block at Tuen Mun Hospital - Phase 1*

Architectural Services Department

## CONTENTS

---

### **1. Project Information** 3

- 1.1 Scope of Works
- 1.2 Project Location
- 1.3 The Team

### **2. Site Environment and Nature of the Works** 4

- 2.1 Site Environment
- 2.2 Nature of the Works

### **3. Identification of Special Hazards** 7

- 3.1 Conduction of Impact Study
- 3.2 Services and Drainage Diversion
- 3.3 Demolition of Blocks B and C

### **4. Documentation** 14

- 4.1 Pre-tender Health and Safety Plan
- 4.2 Special Hazards
- 4.3 Feedback from Tenderers
- 4.4 The Health and Safety File
- 4.5 Project Completion

### **5. Views** 22

- 5.1 Suggestions and Comments
- 5.2 The Way Forward

Appendix I - Pre-Tender Health and Safety Plan for the Demolition of Blocks B and C and Construction of Piled Foundation	26
--	----



## 1. Project Information

### 1.1 Scope of Works

The works in this project comprise the refurbishment of one building (Block A of the former Staff Quarters), demolition of 2 buildings (Blocks B and C of the former Staff Quarters) and construction of a new Rehabilitation Block for the Tuen Mun Hospital.

### 1.2 Project Location

The site of the project is the former Nursing School of the Tuen Mun Hospital, which was converted into administrative offices and staff quarters before this project. The Tuen Mun Hospital is situated on the bank of Tuen Mun River Channel. The site is separated from the main hospital complex by the track of the Kowloon Canton Railway Light Rail Transit (KCR LRT) and the Tsing Lun Road, but is connected by a pedestrian subway running under the railway track and road.



Figure 1 - Site Plan



Figure 2 - Site Photo - Nursing School

## 1.3 The Team

### Designer

The design team (the "Designer") comprises an architect, a structural engineer, a quantity surveyor and a building services engineer; all of them come from the Architectural Services Department (Arch SD).

The designers, under CDM, must carry the following tasks:

- Ensure that structures are designed to avoid risks to health and safety or reduce risks at source if they cannot be avoided altogether.
- To provide adequate information on health and safety and ensure this is passed to the planning supervisor for inclusion in the health and safety plan.

### Planning Supervisor

Meanwhile, a Planning Supervisor has also been appointed for this project. The Planning Supervisor is a senior architect from the same department.

The Planning Supervisor under CDM has to co-ordinate the health and safety aspects of the project design and initial planning and to ensure the co-ordination of the followings:

- A pre-tender safety plan is prepared
- A safety file is prepared
- Designers comply with health and safety duties, are competent and co-operated with each other.

### Contractor

The contractor certainly has a role to play under the CDM system, but the trial covers only up to the tender stage. If the reader wishes to know about the contractor's role, he can refer to the preliminary guidelines.

## 2. Site Environment and Nature of the Works

### 2.1 Site Environment

The site is adjacent to the Castle Peak Hospital (a mental hospital) and Kei Lun Village, a local village, where there are blocks of three storey high vernacular buildings. The

site is isolated from the Tuen Mun Hospital by Tsing Lun Road and a KCR LRT track. There is only one vehicular access to the site through the Tsing Chung Koon Road, which serves the whole site.

Within the site, there are three existing isolated concrete multi-storey buildings. Blocks A and B are two 16-storey building and Block C is only three storey high. Block A originally housed a nursing school and staff call rooms. Due to the restructured training mechanism in the Hospital, the Nursing School in Block A no longer exists and the building is empty. The administration unit of the Hospital currently occupies Block B, while Block C is a minor staff accommodation with limited amount of storage facilities.

There are two retaining wall structures on site that cannot be disturbed. The larger wall is approximately 3.5 metres high which runs the full frontage of the site along the Tsing Lun Road. It is considered that any alteration to this wall may affect the safety of the LRT. The other wall is located at the rear of Block B, where it retains the 5-metre high slope at the Castle Peak Hospital.

The site is completely isolated from the Hospital. The only pedestrian linkage between the Hospital and the staff quarters site is a subway running under the LRT tracks and Tsing Lun Road. This subway serves as a tunnel for building services supplying the buildings on this isolated site from the main hospital complex. The entrance to this subway is in front of Block A, leading to it are two flights of steps. It is also worth noting that the structure of this subway forms part of the foundation structure of Block A.

## **2.2 Nature of the Works**

It is proposed this project should provide a day rehabilitation unit which for the active rehabilitation of patients with chronic illness and disabilities, such as chronic cardiac or respiratory diseases on an ambulatory basis. The unit can enhance continuity of care, facilitate discharge of chronically ill patients from hospitals and their integration into the community after discharge. Moreover, due to the shortage in hospital beds in the cluster, it is proposed that the Rehabilitation Block should also provide 384 convalescent/rehabilitation bed spaces and 128 infirmary bed spaces.

In order to free up the site for the Rehabilitation Block, Blocks B and C are to be demolished. The existing Block A was to be refurbished, so that the existing administration facilities in Block B would be relocated in Block A. Once the refurbishment of Block A is completed with the administration facilities and overnight facilities for the medical staff had moved in, Blocks B and C would be evacuated and demolished.

## WORKED EXAMPLE NO. 1

In short, the project has been sub-divided in 3 phases, due to the complexity of its works nature:

Phase 1 - The works include the refurbishment of the Block A (see Figure 3).

Phase 2 - The demolition of Block B and C, the design and construction of the piling foundation (see Figure 4).

Phase 3 - The construction of the new Rehabilitation Block (see Figure 5)

The 3 phases will be tendered separately as 3 contracts. While the project team is still committed to continue the trial run of CDM on this project, **this worked example only records the process of the CDM that the team had gone through during the design and tender stages of Phases 1 & 2** of the project, i.e. the refurbishment of Block A and the demolition of Block B & C and the piled foundation (2 contracts out of 3).



Figure 3 - Refurbishment of Block A



Figure 4 - Demolition of Blocks B & C and Piling Works



Figure 5 - Construction of New Rehabilitation Block

### 3. Identification of Special Hazards

#### 3.1 Conduction of Impact Study

During the course of the design stage, the Designer and the Planning Supervisor, conduct monthly meetings as a team. Design items relating to CDM from the angle of health and safety, environmental protection, buildability and maintainability are discussed and analyzed, together with the control measures as tabulated in the "Impact Study" chart. Of course, emphasis varies depending on the nature of the operations involved, as demonstrated in the impact study chart.

In the refurbishment of Block A and the demolition of Blocks B and C, the team concentrates on the following key issues during the design stage:

- The safety of the occupants in the existing Blocks while works are in progress, e.g. hoarding layout, temporary emergency vehicle access (EVA) arrangement.
- Delivery logistics, including site vehicles and delivery vehicles for the hospital goods.
- The environmental impact on the neighbouring buildings, e.g. noise, and dust.
- Demolition waste sorting, handling and disposal.
- Demolition sequence for existing service tunnel and Block B & C.
- The type of foundation to be chosen, considering the noise problem.



## WORKED EXAMPLE NO. 1

- The phased diversion works of the existing drainage system, taking into account that Block A will be in normal operation, while Blocks B and C and the drain pipes outside Blocks B and C are being demolished.
- Liaison with LRT on the erection of double deck steel hoarding along the retaining wall of Tsing Lun Road.

The following figures 6 to 9 illustrate the elements which the team has investigated during the pre-tender stage:



Figure 6 - Site preparation for refurbishment of Block A

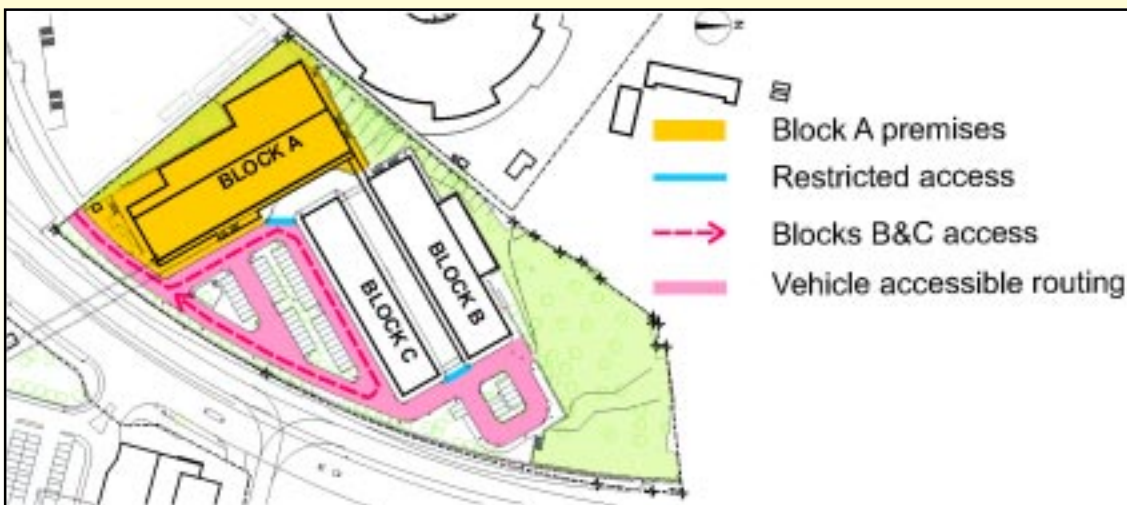

Figure 7 - Site arrangement prior to refurbishment of Block A

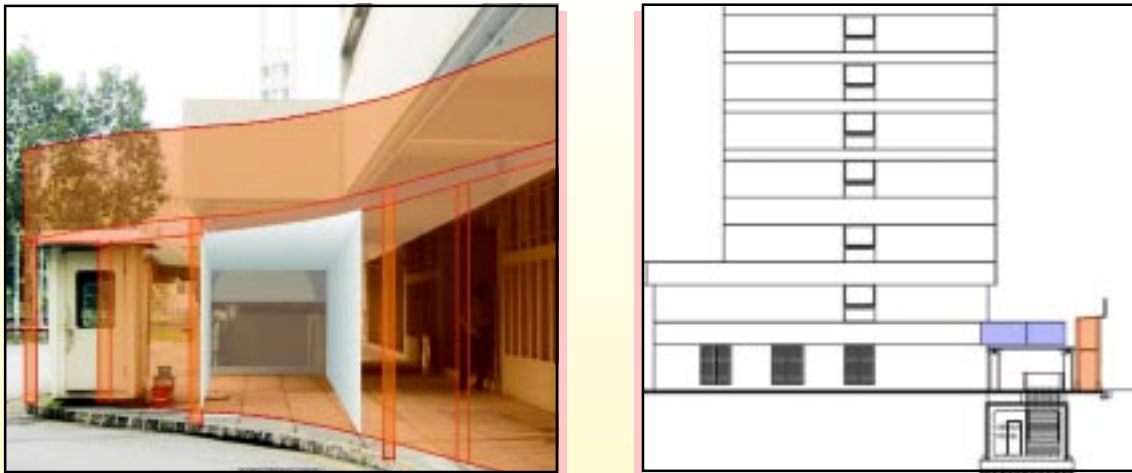

Figure 8 - Construction of hoarding / covered walkway prior to demolition of Block A canopy



Figure 9 - Construction of double-layered scaffolding prior to renovation on facades

### 3.2 Services and Drainage Diversion

Since the network of services including drainage are originally designed to be common to all the 3 blocks, the project presents sticky programming problems as Block A has to be operational while Blocks B and C are being demolished. Temporary site arrangement, prior to the carrying out of the demolition works, has been carefully considered. These include a tentative programme for the termination of various services, e.g. electricity and water supplies to Block B and C. Special termination points have to be installed to keep Block A functional when supplies to Blocks B and C are cut off, so that the relocated administrative unit of the Hospital can be unaffected when they are working in the refurbished Block A.

## WORKED EXAMPLE NO. 1

Amongst all the diversion works, the diversion of the existing drainage seems to be more complicated than expected. A throughout logistic planning was proposed at the time of design, as initially before Block A is refurbished, it is empty, but Blocks B and C are occupied, and subsequently, Block A becomes occupied (by the administrative unit), and Blocks B and C are to be demolished, but all 3 blocks share a common drainage system, up to the last manhole.

It is decided in order to maintain the drainage from Blocks B and C working until Block A is renovated, a new set of manholes is used to link up some of existing manholes to bypass the existing routings of the drainage system.

Therefore, all drainage systems are to be diverted before the full occupancy of Block A.

### 3.3 Demolition of Blocks B and C

For the demolition of Blocks B and C, it is particularly worth to note that the team, after reviewing the extent of the works with the in-house Health and Safety Advisor, has decided to employ the expertise of a demolition consultant. The demolition consultant is engaged to work out the feasible approaches for demolition works; particularly in Block B, where pre-stressed concrete slabs are found on the 3<sup>rd</sup> floor of the Block.

The following figures explain the study of the extent of works required for the demolition of Block B and C.

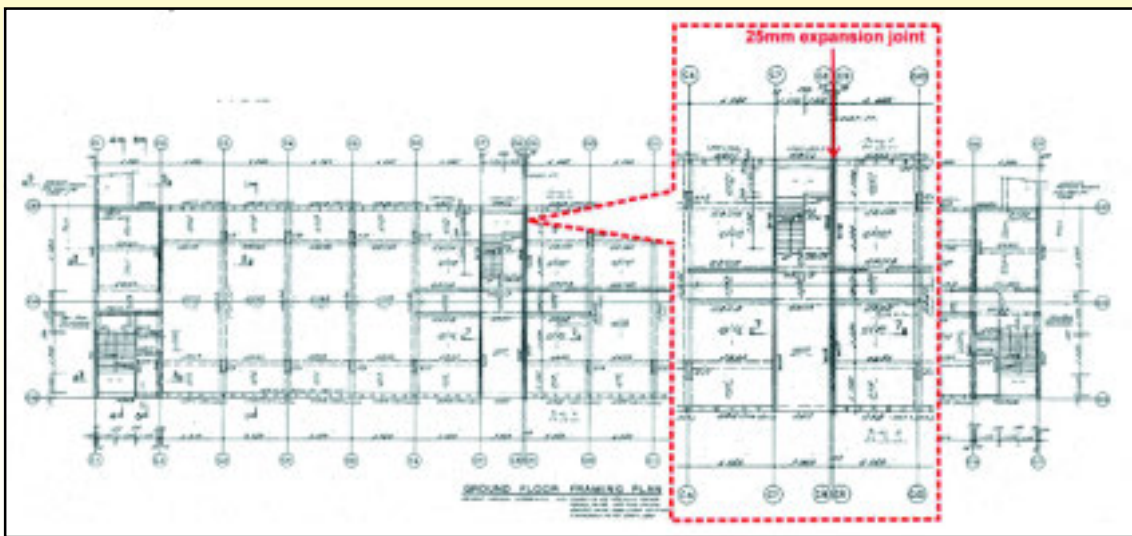

Figure 10 - Demolition of Block C - Expansion Joint



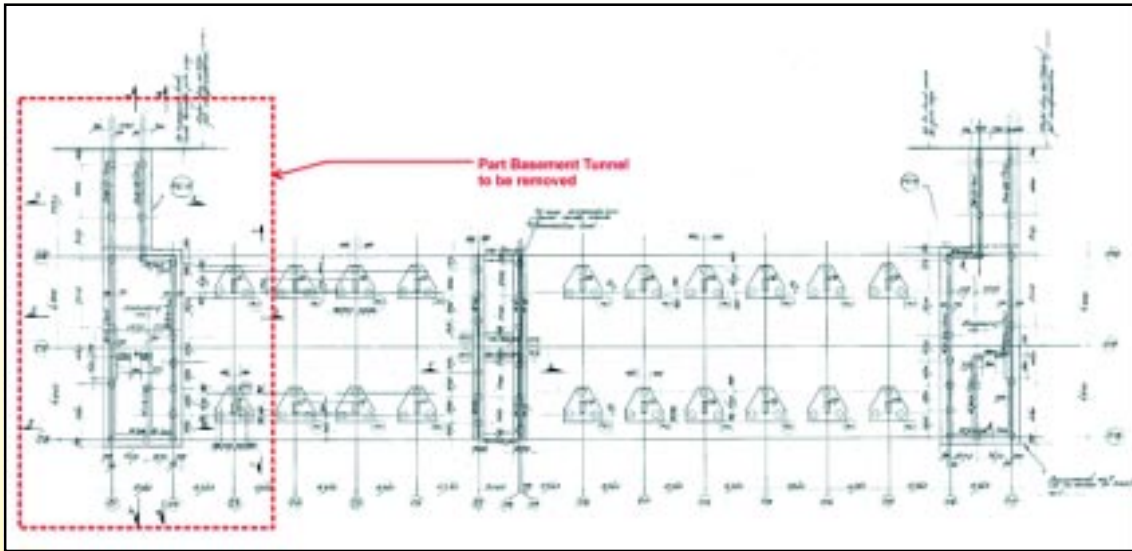

Figure 11 - Demolition of Block C - Basement Tunnel

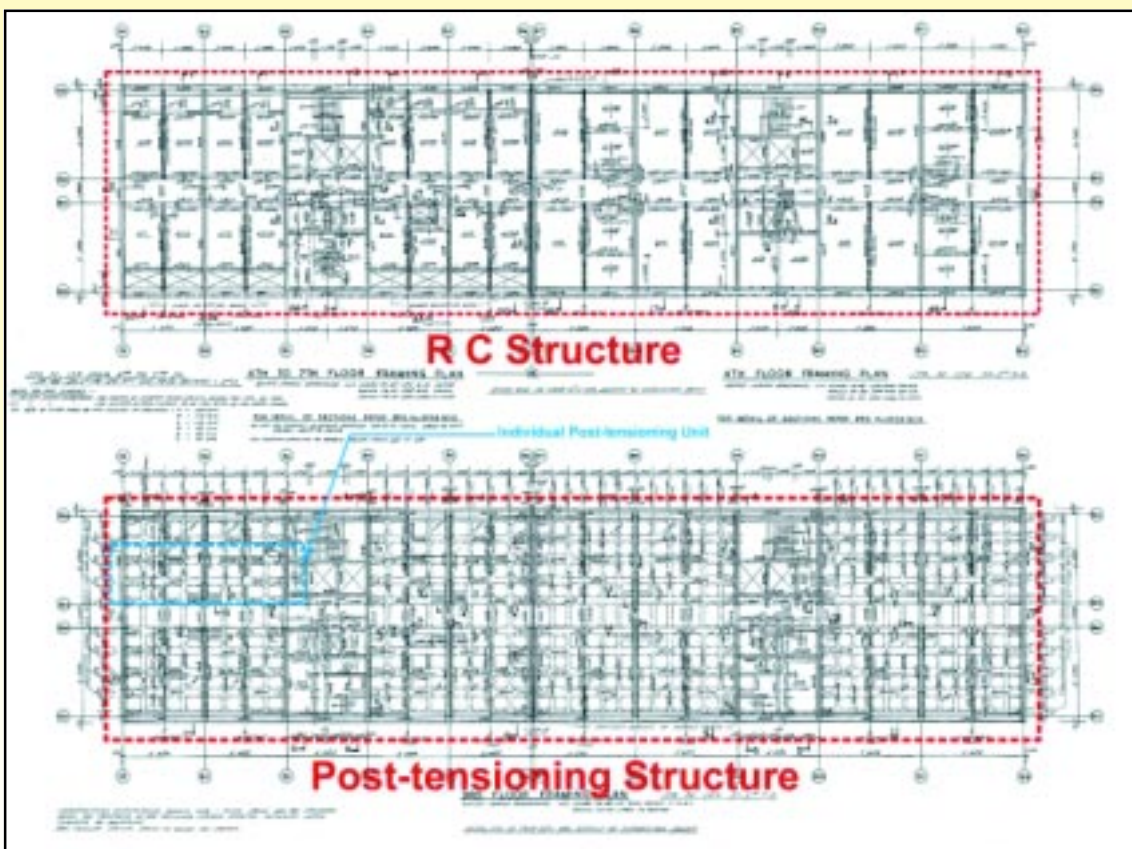

Figure 12 - Demolition of Blocks B & C - Post-tensioning Structure

WORKED EXAMPLE NO. 1



Figure 13 - Demolition of Block B - Existing Retaining Wall

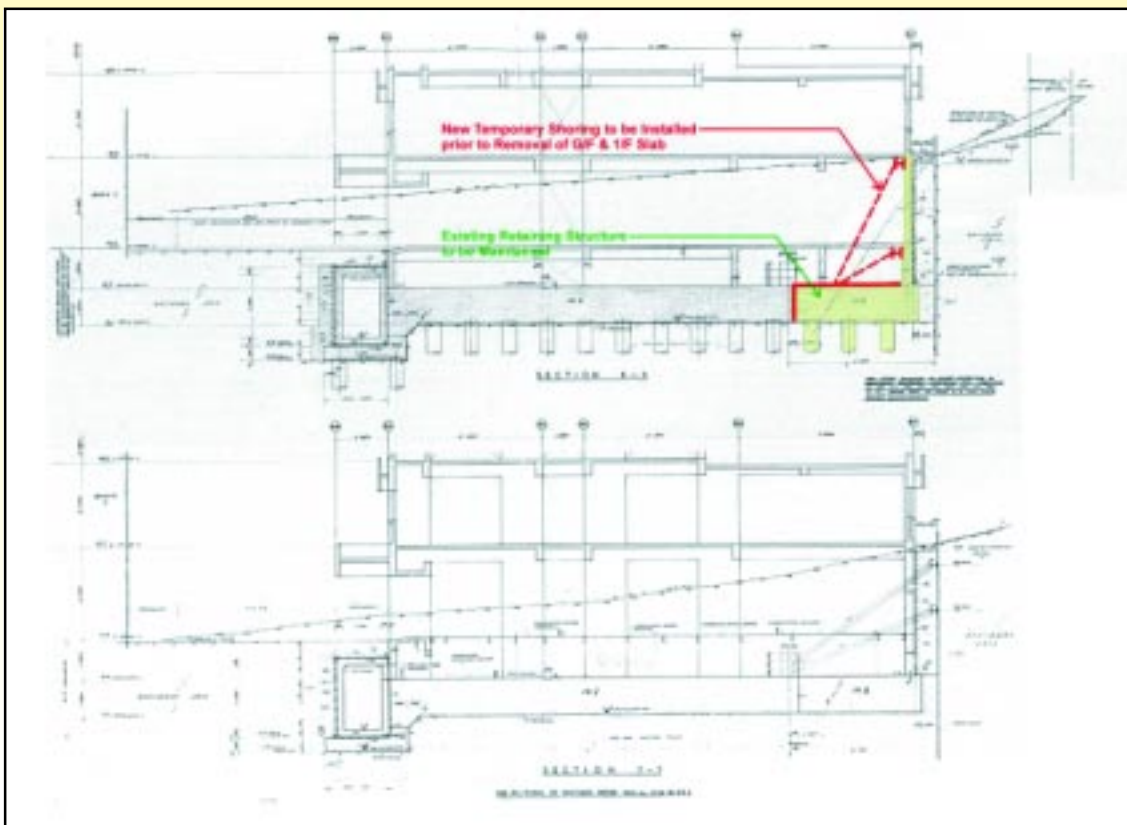

Figure 14 - Demolition of Block B - Existing Retaining Wall

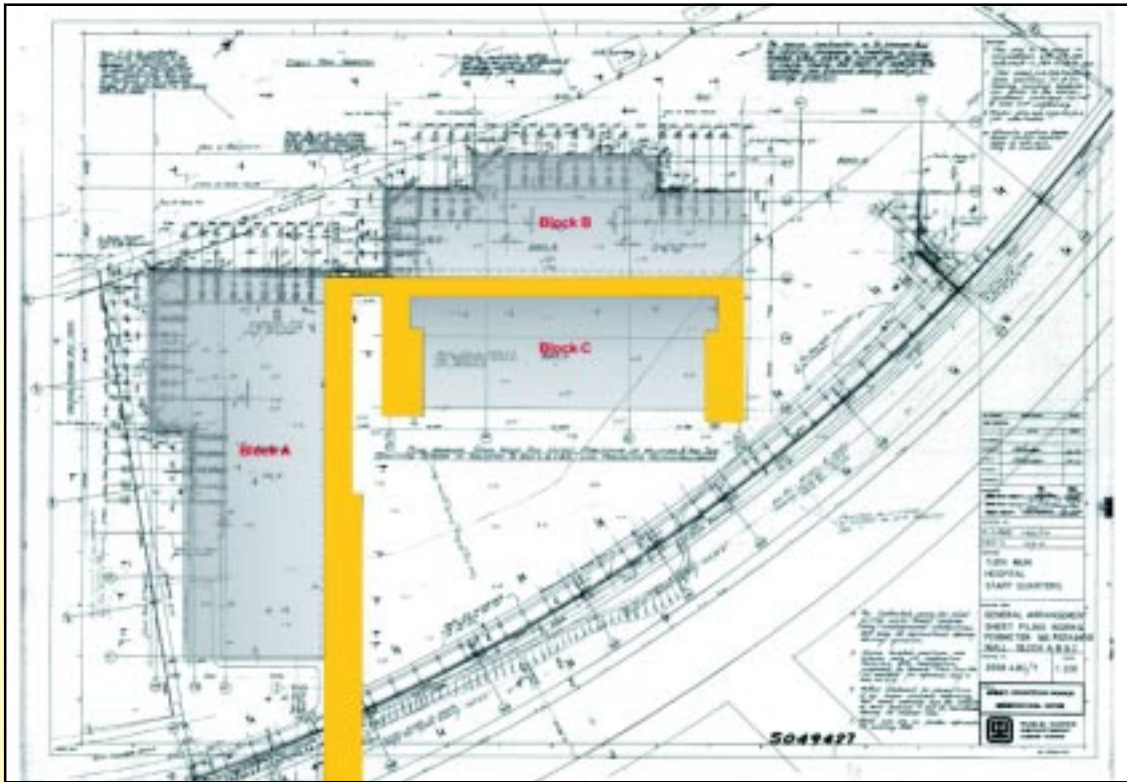

Figure 15 - Demolition of Blocks B & C - Existing Service Tunnels

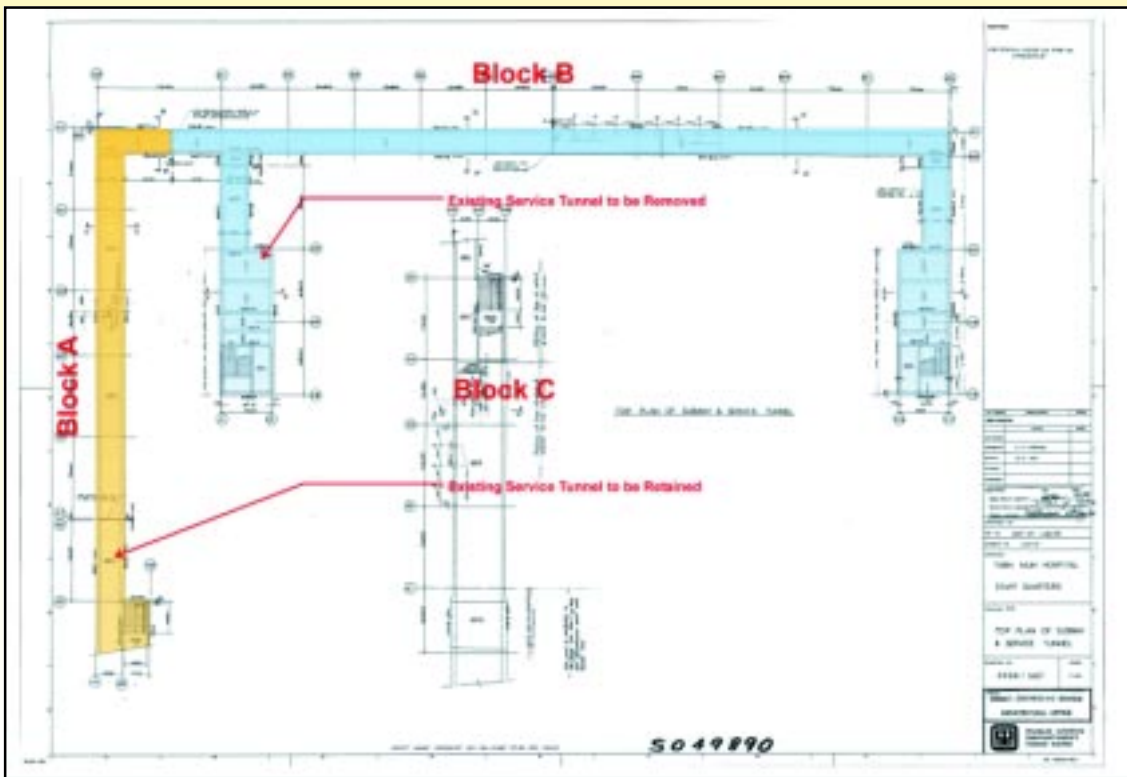

Figure 16 - Demolition of Blocks B & C - Existing Service Tunnels



## 4. Documentation

### 4.1 Pre-tender Health and Safety Plan

As part of the requirements of CDM, the Designer and the Planning Supervisor have to prepare a Pre-tender Health and Safety Plan for each of Phase 1 and Phase 2 contracts. The plans describe the works and risks involved (full health and safety plans should be individually developed for the construction phase of each contract later). This document describes and summarizes the project to the prospective contractors, who may not have a clear overview or awareness of the complexity of the project at the tendering stage. The Plan has to include the following information:

- A description of the project
- Arrangements for managing the project and monitoring compliance with health and safety requirements.
- Identify the special hazards relating to health and safety (and hence environmental protection, buildability and maintainability).
- Arrangement for the welfare of people working on the project.

It is also worth knowing that even without CDM, the above information is conveyed to tenderer, through items included in the Preliminaries, the Scope of Works description and the Special Conditions of Contract. However, these are normally scattered around the tender document and may be easily missed. Under CDM, the Pre-tender Health and Safety Plan gives a concise message to the tenderer about the project.

The Plan is included as an attachment to the tender documents. However, currently the Plan is not contractually binding as this is a trial project for CDM.

For illustration, the Pre-tender Health and Safety Plan for the contract: "Demolition of Block B and C and the Construction of Piled Foundation" of this project are attached as Appendix I to this case study.

The Plan, under the requirement of CDM, has to be continuously developed by the Main Contractor, over the course of the Contract, into a "project specific" Health and Safety Plan.

### 4.2 Special Hazards

The impact study as described in Section 3.1 above has been presented to the Hospital representatives (the Client) and has been developed further to formulate the final

document called Special Hazards, which alerts the contractors' attention on the specific items during the tender stage. An example of the document is presented below in Table 1 showing the Special Hazards identified for the refurbishment of Block A (one contract) and a separate set of Special Hazards is compiled for the demolition of Block B and C and piling works in Table 2. The latter deals mainly with hoarding, catch fans and the dismantling of the pre-stressed structure of Block B.

**Table 1 - Special Hazards for refurbishment Block A**

BLOCK A	HAZARD	DESIGN CONSIDERATIONS	CONTRACTOR'S ATTENTION	NOTES
1.	<ul style="list-style-type: none"> <li>Removal of the existing polycarbonate cover and the associated metal frame to service tunnel</li> <li>Construction of the new cover for the entrance of the pedestrian tunnel</li> </ul>	<ul style="list-style-type: none"> <li>Liase with hospital administration on detailed arrangement such as temporary closure of the tunnel at hospital's most convenient time</li> <li>Maximise the possibility of prefabrication in order to minimise the time for construction of the new cover</li> </ul>	<ul style="list-style-type: none"> <li>Minimise the time for removal of the existing cover</li> <li>Co-operate with hospital administration's arrangement and provide necessary temporary arrangements</li> <li>Before constructing the new cover, erect heavy-duty protective cover for tunnel user</li> <li>Minimise the time for the construction of the new cover such as prefabrication</li> </ul>	<ul style="list-style-type: none"> <li>To address in the Safety Plan and establish a detailed works schedule</li> <li>To address in the hoarding plan and demolition plan</li> <li>To consider prefabrication in the design of the new cover</li> </ul>
2.	<ul style="list-style-type: none"> <li>Demolition of suspended ground floor slab</li> </ul>	<ul style="list-style-type: none"> <li>Avoid removal of continuous slab/beam system</li> <li>Specify saw cut to minimise damage to adjacent structure</li> <li>Specify the requirements of competent site supervision</li> </ul>	<ul style="list-style-type: none"> <li>Provide temporary support (hanger) to slab and beam before demolition to avoid sudden collapse</li> <li>Dangerous gas detection/relieve measures to the underneath of the suspended slab for any possible accumulation of dangerous gas</li> <li>Provide competent site supervisions for demolition works</li> </ul>	<ul style="list-style-type: none"> <li>To address in the Safety Plan and Demolition plan</li> </ul>
3.	<ul style="list-style-type: none"> <li>Demolition of cantilevered canopy at First floor</li> </ul>	<ul style="list-style-type: none"> <li>Specify saw cut to minimise noise and avoid damage to adjacent structure</li> <li>Specify the requirements of competent site supervision and protective measures such as double scaffolding/working platform, catch fan and protective screen etc. for the demolition work</li> </ul>	<ul style="list-style-type: none"> <li>Provide protective measures and double scaffolding/working platform for the facade demolition and new cladding construction</li> <li>Provide temporary support to the elements to be demolished</li> <li>Provide competent site supervisions for demolition works</li> </ul>	<ul style="list-style-type: none"> <li>To address in the Outline Safety Plan and Demolition plan</li> </ul>

## WORKED EXAMPLE NO. 1

**Table 1 - Special Hazards for refurbishment Block A**

BLOCK A	HAZARD	DESIGN CONSIDERATIONS	CONTRACTOR'S ATTENTION	NOTES
4.	<ul style="list-style-type: none"> <li>Demolition of external facade for new cladding</li> </ul>	<ul style="list-style-type: none"> <li>Specify saw cut to minimise noise and avoid damage to adjacent structure</li> <li>Specify the requirements of competent site supervision and protective measures such as double scaffolding/ working platform, catch fan and protective screen etc. for the demolition work</li> </ul>	<ul style="list-style-type: none"> <li>Provide protective measures and double scaffolding/ working platform for the facade demolition and new cladding construction</li> <li>Provide temporary support to the elements to be demolished</li> <li>Provide competent site supervisions for demolition works</li> </ul>	<ul style="list-style-type: none"> <li>To address in the Outline Safety Plan and Demolition plan</li> </ul>
5.	<ul style="list-style-type: none"> <li>Demolition of internal wall partitions</li> </ul>	<ul style="list-style-type: none"> <li>For load-bearing wall, specify saw cut to minimise noise and avoid damage to adjacent structure</li> <li>Specify stiffening details to strengthen load-bearing walls that require new openings</li> </ul>	<ul style="list-style-type: none"> <li>Provide temporary support to the elements to be demolished, in particular, brickwork partitions</li> <li>Provide competent site supervisions for demolition works</li> </ul>	<ul style="list-style-type: none"> <li>To address in the Safety Plan and Demolition plan</li> </ul>
6.	<ul style="list-style-type: none"> <li>Demolition of lift shaft openings for new lift door</li> </ul>	<ul style="list-style-type: none"> <li>Specify saw cut to minimise noise and avoid damage to adjacent structure</li> <li>Specify stiffening details to strengthen new opening</li> </ul>	<ul style="list-style-type: none"> <li>Provide working platform / catch platform inside lift shaft for safety and protective purposes</li> <li>Provide competent site supervisions for demolition works</li> </ul>	<ul style="list-style-type: none"> <li>To address in the Safety Plan and Demolition plan</li> </ul>
7.	<ul style="list-style-type: none"> <li>Drainage diversion, Block A site and along eastern boundary retaining wall</li> </ul>	<ul style="list-style-type: none"> <li>Advance drainage diversion to facilitate good site drain management for later phases of overall redevelopment project</li> <li>Advise LRT on the proposal for any requirements for monitoring measures</li> <li>Identify services that may be affected by the diversion work</li> </ul>	<ul style="list-style-type: none"> <li>Liase with LRT on the details of monitoring measures</li> <li>Existing services either above ground or underground to be detected, identified and avoid / divert where possible</li> </ul>	<ul style="list-style-type: none"> <li>To address in the Safety Plan and Demolition plan</li> </ul>

**Table 2 - Special Hazards for the demolition of Blocks B and C and construction of piled foundations**

BLOCKS B & C	HAZARD	DESIGN CONSIDERATIONS	CONSTRUCTION CONSIDERATIONS	TENDERER/ CONTRACTOR
<b>General</b>				
1.	<ul style="list-style-type: none"> <li>Hoarding</li> </ul>	<ul style="list-style-type: none"> <li>Covered walkway provided for pedestrian movement in adjacent to LRT</li> <li>Non-standard protective hoarding for adjacent private lot</li> <li>Heavy-duty protection to areas in adjacent to demolition operation</li> <li>Designated covered walkway for hospital operatives</li> </ul>	<ul style="list-style-type: none"> <li>Comply with LRT's requirements on work in and adjacent to LRT line</li> <li>Erect hoarding with minimum disturbance to neighbourhood</li> <li>Adopt all necessary protective measures during demolition operations</li> <li>Regular inspection and maintenance to all hoarding or covered walkway to ensure good condition</li> </ul>	<ul style="list-style-type: none"> <li>To address in the Safety Plan and Demolition plan</li> </ul>
2.	<ul style="list-style-type: none"> <li>Existing Services</li> </ul>	<ul style="list-style-type: none"> <li>Identify services that may be affected by the piling and demolition work</li> <li>Advise utility companies to make advance diversion prior to commencement of piling and demolition work</li> <li>Advance services diversion to suit the schedule services cut-off time that reflect hospital's planning on decanting</li> <li>Advance drainage diversion to minimise disruption to piling and demolition operations and facilitate good site drainage management for later phases of overall redevelopment project</li> <li>Advance drainage diversion to minimise the risk of disrupting Block A operations during piling and demolition works</li> </ul>	<ul style="list-style-type: none"> <li>Identify and verify with utility companies of the state of services for both under and above ground</li> <li>Conduct site inspection and investigation on possibility of any unidentified services</li> <li>Excavation, piling and demolition works shall be carried out with extreme care on possible presence of unidentified services</li> <li>Existing live services either above ground or underground to be detected, identified and protect/divert where possible</li> <li>Provide temporary measures to protect the diverted drains serving Block A</li> </ul>	<ul style="list-style-type: none"> <li>To address in the Safety Plan, piling method statement and demolition plans</li> </ul>
3.	<ul style="list-style-type: none"> <li>Emergency Vehicle Access</li> </ul>	<ul style="list-style-type: none"> <li>Identify the EVA and the means of how emergency vehicle operate for the user in Block A</li> <li>Modify hoarding line and construction site boundary to suit the above requirement</li> </ul>	<ul style="list-style-type: none"> <li>Ensure no works or obstruction all along the EVA at any time through out the contract</li> <li>Ensure the "gate" right across the EVA is 24-hour manned and keep the "gate" opened when necessary</li> <li>Secure and ensure no public can enter the non-public and non-work area in adjacent to existing Block C</li> </ul>	<ul style="list-style-type: none"> <li>To address in the Outline Safety Plan, Safety Plan, temporary work proposal, piling method statement and demolition plan</li> </ul>

Table 2 - Special Hazards for the demolition of Blocks B and C and construction of piled foundations

BLOCKS B & C	HAZARD	DESIGN CONSIDERATIONS	CONSTRUCTION CONSIDERATIONS	TENDERER/ CONTRACTOR
<b>Piling and Earthwork</b>				
4.	<ul style="list-style-type: none"> <li>Piling operation</li> </ul>	<ul style="list-style-type: none"> <li>Specify pile type to minimise noise, vibration and nuisance to neighbours</li> <li>Specify pile type to suit ground condition</li> <li>Liase with hospital administration on requirements of site works under operating hospital environment. (Not only Tuen Mun hospital but also Castle Peak Hospital)</li> <li>Advise LRT on the proposal for any requirements for monitoring measures</li> </ul>	<ul style="list-style-type: none"> <li>Special attention on site operations under operating hospital environment</li> <li>Co-ordinate with hospitals' administration on works that affect hospital operations such as material delivery arrangement, noisy work schedule etc.</li> <li>Special attention on minimising any disruption to neighbouring villages and residents. Where necessary, modify construction method/sequence to achieve such objective</li> <li>Agree with LRT on details of monitoring measures, the installation and operation of the agreed monitoring measures</li> </ul>	<ul style="list-style-type: none"> <li>To Submit tender information regarding the specified pile type</li> <li>To address in the Outline Safety Plan, Safety Plan, and indicate allowances made in works programme</li> </ul>
5.	<ul style="list-style-type: none"> <li>Limits on pile locations</li> </ul>	<ul style="list-style-type: none"> <li>Set back pile locations to avoid damaging the retaining wall along the LRT lines</li> <li>Set back piles location at the northern end of the site to minimise disruption to neighbouring villages</li> </ul>	<ul style="list-style-type: none"> <li>Closely monitoring the condition and stability of the retaining walls all long the boundary with the LRT</li> <li>Where necessary, install temporary supports to the wall during the piling operations</li> <li>Where necessary, modify pile installation method and machine to achieve these objectives</li> </ul>	<ul style="list-style-type: none"> <li>To address in the Safety Plan and piling method statement</li> </ul>
6.	<ul style="list-style-type: none"> <li>Limits on extent of ground supports for superstructure</li> </ul>	<ul style="list-style-type: none"> <li>Maximise the use of cantilevered superstructure</li> <li>Minimise the extent and amount of excavation especially along site boundary</li> <li>Make use of existing pile where possible in the new development</li> </ul>	<ul style="list-style-type: none"> <li>Provide temporary work (non-percussive type) for excavation along site boundary</li> </ul>	<ul style="list-style-type: none"> <li>To address in the Safety Plan, piling method statement and demolition plan</li> </ul>
7.	<ul style="list-style-type: none"> <li>Slope and earthwork works</li> </ul>	<ul style="list-style-type: none"> <li>Retain most of existing retaining wall to minimise the amount of slope work that could cause more disruption to neighbouring villages</li> <li>Retain nearly half of the Block B pile raft to minimise the amount of excavation work</li> <li>In pile cap design, specify the pile cap finished level to suit existing ground profile as far as possible so as minimise the amount and extent of earthwork</li> <li>Individualise the pile caps to minimise their thickness</li> </ul>	<ul style="list-style-type: none"> <li>Where excavation along the slope is unavoidable, install non-percussive type temporary works to minimise disruption to neighbour, to limit the disruption to the slope structure and to minimise the amount of excavation</li> <li>In pile cap design, minimise pile cap thickness to the minimum specified to avoid unnecessary excavation</li> </ul>	<ul style="list-style-type: none"> <li>To address in the demolition plan and pile cap design</li> </ul>



**Table 2 - Special Hazards for the demolition of Blocks B and C and construction of piled foundations**

BLOCKS B & C	HAZARD	DESIGN CONSIDERATIONS	CONSTRUCTION CONSIDERATIONS	TENDERER/ CONTRACTOR
<b>Demolition of Blocks B and C</b>				
8.	<ul style="list-style-type: none"> <li>Post-tensioned prestressed concrete structure in Block B</li> </ul>	<ul style="list-style-type: none"> <li>Appoint specialist consultant to supervise the overall demolition work</li> <li>Identify two possible approaches with necessary safety precautionary measures</li> <li>Specify the essential demolition sequences and safety precautionary measures</li> <li>Specify the requirement of propping with spreader beam on 3/F to avoid propping standing on slabs with void underneath</li> <li>Specify the requirement of checking grouting condition of tendons</li> <li>Specify no cutting near the anchor ends before lifting onto the ground</li> <li>Specify blocks to be placed underneath the beam to provide level support for the beam when sitting on ground</li> <li>Specify the breaking of the prestressed structure in an enclosed place with minimum exposure to avoid tendon shoot-off and concrete fly-out</li> <li>Specify the requirements of the site engineer to enhance the Health and Safety issue</li> </ul>	<ul style="list-style-type: none"> <li>Employ demolition specialist with particular attention to this particular feature</li> <li>Employ extra safety measures during the demolition of this part of structure</li> <li>Carry out all necessary safety precautionary measures to cater for any possible adverse consequences such as ineffective / detensioning grout or debonding occurrences</li> <li>Provide sufficient protective measures at the ends of prestressed beams at any time to prevent tendon's accidentally shoot-off.</li> <li>Provide temporary support to the prestressed structures before demolition to avoid sudden collapse</li> <li>Design lifting method and device to prevent overstressing of prestressed beam, unexpected movement, toppling sideways, unbalanced support and sudden dropping</li> <li>In determining the demolition sequence, carry out checking of the change of stress level of prestressed beam at every stage of the demolition to ensure no overstressing will occur</li> <li>Inspect and verify tendon grout condition before demolition</li> <li>Place the beams on levelled firm ground and turned on their side in a controlled manner</li> <li>Provide protective screen for the machine operator during breaking up of prestressed beam</li> <li>Fence off the area during breaking up of prestressed beam to clear of any personnel</li> <li>Break up and fully detensioned the prestressed beams before carting off site. Justify the extent of the demolition to size that would not cause problem / risk to Health &amp; Safety</li> <li>Where necessary, provide alternative method to achieve these objectives</li> <li>Provide induction-training course to all workers regarding the presence of such structures and the hazards of deviating from the prescribed procedures</li> </ul>	<ul style="list-style-type: none"> <li>To address in the Outlined Safety Plan, Safety Plan, Preliminary Demolition Plan and Demolition Plan</li> <li>To make sufficient allowance in master programme</li> </ul>

**Table 2 - Special Hazards for the demolition of Blocks B and C and construction of piled foundations**

BLOCKS B & C	HAZARD	DESIGN CONSIDERATIONS	CONSTRUCTION CONSIDERATIONS	TENDERER/ CONTRACTOR
9.	<ul style="list-style-type: none"> <li>General demolition works</li> </ul>	<ul style="list-style-type: none"> <li>Liaise with hospital administration on requirements of site works under operating hospital environment</li> <li>Advise LRT on the proposal for any requirements for monitoring measures</li> <li>Identify the essential demolition sequence and safety precautionary measures</li> <li>Specify a high screen cover with demountable noise barrier to minimise noise and dust</li> <li>Make use of lift shaft with plastic refuse chute to minimise noise production and to prevent open-up of slab</li> <li>Specify the limit of excavator's movement within the designated propped zones</li> <li>Specify the requirements for vibration and settlement monitoring on adjacent structures</li> </ul>	<ul style="list-style-type: none"> <li>Provide all necessary protective measures for the demolition work</li> <li>Co-ordinate with hospital administration and sequence the works to cause the least effect on hospital operations</li> <li>Liaise with LRT on details of monitoring measures</li> <li>Provide competent site supervisions for demolition works</li> <li>Minimise noise by adopting appropriate method, sequence, equipment and silencing device where necessary</li> <li>Provide structural design and carry out routine inspection on the support of the high scaffolding / screen cover</li> <li>Provide temporary support where necessary for partial demolition of 1/F slab to collect the debris</li> </ul>	<ul style="list-style-type: none"> <li>To address in the Safety Plan and Demolition Plan</li> </ul>
10.	<ul style="list-style-type: none"> <li>Demolition of external walls, architectural fins / features</li> </ul>	<ul style="list-style-type: none"> <li>Specify the requirements of applying tie wires or equivalent for the demolition work</li> </ul>	<ul style="list-style-type: none"> <li>Provide cover to voids adjacent to features to prevent objects falling</li> <li>Provide competent site supervisions for demolition works</li> </ul>	<ul style="list-style-type: none"> <li>To address in the Safety Plan and Demolition Plan</li> </ul>
11.	<ul style="list-style-type: none"> <li>Demolition of cantilevered canopy at 1/F</li> </ul>	<ul style="list-style-type: none"> <li>Specify the demolition sequence should be prior to demolition of main building</li> </ul>	<ul style="list-style-type: none"> <li>Provide temporary support to the cantilevered canopy before demolition</li> <li>Provide competent site supervisions for demolition works</li> </ul>	<ul style="list-style-type: none"> <li>To reflect work sequences in the master programme</li> <li>To address in the Safety Plan and Demolition Plan</li> </ul>
12.	<ul style="list-style-type: none"> <li>Retain the existing retaining walls at Block B</li> </ul>	<ul style="list-style-type: none"> <li>Design a "engineering-designed" temporary work to support the retaining wall</li> <li>Simplify the layout to minimise conflict with demolition work and future construction work</li> </ul>	<ul style="list-style-type: none"> <li>Install the temporary support before demolition of 1/F slab and G/F slab</li> <li>Closely monitor the condition and stability of the retaining wall during demolition</li> <li>Maintain the retaining wall and the temporary support in a good condition throughout the contract</li> <li>Provide competent site supervisions for demolition works</li> </ul>	<ul style="list-style-type: none"> <li>To reflect work sequences in the master programme</li> <li>To address in the Safety Plan and Demolition Plan</li> </ul>

**Table 2 - Special Hazards for the demolition of Blocks B and C and construction of piled foundations**

BLOCKS B & C	HAZARD	DESIGN CONSIDERATIONS	CONSTRUCTION CONSIDERATIONS	TENDERER/ CONTRACTOR
13.	<ul style="list-style-type: none"> <li>Demolition of pile cap &amp; underground services tunnel</li> </ul>	<ul style="list-style-type: none"> <li>Specify manual demolition near the cut line to minimise damage to the remaining cap</li> <li>Limit cut angle of open excavation to minimise chance of collapse</li> <li>Specify backfilling the excavated area after demolition to avoid ponding and leaving the pit for possible long exposure</li> <li>Liase with EMSD and hospital administration on the disconnection of all services prior to demolition</li> <li>Limit the demolition bay by bay with maximum 10m to avoid largely exposed trench excavation and to demolish the tunnel in a controlled manner</li> </ul>	<ul style="list-style-type: none"> <li>Provide competent site supervisions for demolition works</li> <li>Install non-percussive type shoring to the specified areas to minimise disturbance to the neighbour and maintain the EVA</li> <li>Inspection on the services system before demolition to ensure the termination</li> <li>Provide temporary drainage system to avoid ponding</li> </ul>	<ul style="list-style-type: none"> <li>To reflect work sequences in the master programme</li> <li>To address in the Safety Plan, Preliminary Demolition Plan and Demolition Plan</li> </ul>

### 4.3 Feedback from Tenderers

The feedback from the Tenderers of demolition contract is not known at the time of writing this case worked example. However, for the refurbishment works in Block A, tenderers have responded with little or no input to the requirements listed out in the Specific Hazard schedule enclosed in the tender documents. It is noted that the tenderers are still not used to responding to such in the submitted outline safety plans during tender stage. They have managed to address these in their method statement and programme submitted after award of tender.

### 4.4 The Health and Safety File

At the completion stage of a project, the Main Contractor should coordinate with all his sub-contractors to collate all information to be included in a document called the Health and Safety File. The Health and Safety File is a record of information for the future use by the client or the end user. The information the File contains will alert the relevant people the key health and safety risks that will need to be dealt with during subsequent maintenance, repair, alteration and demolition work.

The Principal Contractor needs to obtain details of building services, plant and equipment which are part of the building from specialist suppliers and installers and consolidates them into the Health and Safety File. Information can be the "as built" and "as installed" drawings as well as operation and maintenance manuals.

At the end of the project the Planning Supervisor shall hand over the Health and Safety File to the Client.

### 4.5 Project Completion

When the project is finished and the Health and Safety File has been handed over by the Planning Supervisor, the Client shall ensure the File is available for those who need to use it; for instance, maintenance contractors and alteration contractors.

Ideally, the File shall be made available for inspection at the premises. It will be useful to store the file in two parts. One part will be more relevant for day-to-day use, e.g. operational and maintenance manuals. The other part will be for long-term use, e.g. drawings which will only be required when major alteration works are carried out.

This practice will therefore ensure the total quality of the works be effectively and properly maintained throughout the life of the building.

## 5. Views

### 5.1 Suggestions and Comments

CDM is a considerate approach to the avert potential safety, health and environmental hazards starting from the design stage. There is no doubt that CDM is a systematic way to deal with health and safety throughout the course of planning and construction works. However, if the yardstick of whether this documented management system can cut accidents in construction, experience from U.K. is not encouraging.

It is perhaps impossible to comment on the system, unless the different roles in a construction project are reviewed. The following tries to bring out the responsibility of each stakeholder, with regards to the health and safety aspects in construction.

The Clients, as promoters and funders of new works, are in a prime position for setting the conditions that drive health and safety improvements in their projects. The starting point is to have a clear understanding of the significant health and safety

risks within a particular project and to communicate them to the contracting organization at an early stage so that solutions can be sought to control these risks. In this respect, the Planning Supervisor's role under the CDM can have great potential to add value, provided that he or she is proactive enough to ensure that health and safety considerations are properly integrated into the project design as it develops.

A commonly held view is that there was often insufficient time to plan and establish the systems and processes that should be in place to manage health and safety. Clients have a responsibility to establish a realistic programme. Furthermore, health and safety management systems should be integrated into the principal management systems so that they are not simply seen as an add-on. For instance, the preparation and delivery of the Pre-tender Plan, the Construction Safety Plan and the Health and Safety File should all appear as milestones in the Project Programme. Contractors and professionals have a duty to advise clients when the demands of the programme are unreasonable and could have health and safety implications.

Concerns are expressed that systems and procedures are often too complicated and may turn people away. Simplicity is important in improving the level of understanding and compliance, linked to proper training. The system should also allow inputs to be tailored to be proportional to the health and safety risks associated with the work and the difficulty in managing those risks. Therefore, in the case of small low risk projects very little input is required. If the project is complex and the risks are high, much more input is needed. This should be borne in mind when drawing up the Hazards Summary in the tender documents.

The role of the Planning Supervisor should have the potential of making a real difference to a project by the integration of safety into design. In order to make CDM work effectively, the Planning Supervisor must be proactive in discussing and implementing the health and safety issues, but the contractor should also communicate with the Planning Supervisor on his methods and procedures of dealing with the residual risks in a project.

Education and training should also play a role in the success of CDM. It relies largely on the knowledge and awareness of the Design Team, Planning Supervisor and the Contractor about the issues involved. It was pointed out in the U. K. that currently there is no formal requirement for health and safety to be included in the curriculum for University and higher education courses. Many graduates arriving at construction sites with no significant awareness of health and safety issues which they are supposed to be managing, or the legal responsibilities carried by the company. Tertiary educational institutes, professional bodies and associates should be encouraged to offer related courses.

A sense of involvement is considered to be a key factor in successful health and safety management. The workforce should be consulted and participate in the preparation of procedures to generate a sense of ownership.

Safety is often perceived by smaller companies as expensive due to the expertise or systems involved and the cost will never be recovered. Therefore, they would rely upon the main contractor to supply them with skills in this area. The main contractor should have the responsibility to ensure his sub-contractors are competent to carry out their work safely and the main contractor should do more to promote safety amongst his sub-contractors, through their sub-contracting policies.

### 5.2 The Way Forward

CDM would merely become a sterile documented policy, if the awareness of health and safety amongst the construction industry remain low. It would become a new burden to the professionals, if it fails to integrate properly into the existing quality management systems within the building industry, for instance, the Authorized Persons / Registered Structural Engineers system and the Total Quality Management (TQM).

In order to improve the benchmarks for health and safety in the local construction industry, each stakeholder has his responsibilities, and the followings are just some suggestions:

#### **The Industry**

- Encourage and develop industry-wide standards for safety and welfare training.
- Provide case studies, statistical data and methodologies for organisations to be aware of the real cost of poor health and safety performance, so they can make the correct decision.
- OSHC can publish an industry newsletter tracing current safety hazard trends and their causes.
- Improve basic health and safety awareness training and on the topic of CDM at colleges and universities.
- Encourage professionals to advise Clients when programmes are unrealistically short, at the expense of health and safety.

### **The Client**

- Focus more on health and safety risks at an early stage in the development of a project.
- Works more closely with contractors to engender a positive safety culture

### **The Contractor**

- Seek ways to achieve greater continuity of employment to ensure effective investment in health and safety training.
- Ensure that hazard management training can reach the workforce and risk assessment are undertaken by top management.
- Ensure two-way communication on health and safety issues
- Demonstration of commitment at the senior level

Under CDM, procurement method in building contract might deviate from the traditional standard form of contract, e.g. Partnering-style contracting arrangements can be seen as a preferred vehicle for undertaking projects, allowing risk knowledge to be shared at an early stage and appropriate control measures to be built into the design development.

Contracts with CDM might not be more expensive than the ones without, since in the long run, running and maintenance costs will be lowered, as hidden costs from future maintenance problems due to design faults can be uncovered at an early stage. The profitability and efficacy of the supply chain, and, ultimately, the total quality of the product can thus be improved.

In conclusion, Construction (Design and Management) is the first step to make project specific health and safety items "visible" to all. In order to make the construction site a safe place to work, it still needs the maximum level of commitment within the industry. Systems and procedures are, however, just that - it is people who bring them to life and make them work.

In future, as more data is collected from CDM projects, such as materials options, risk assessments, and maintenance options, they can be used for further analysis with information technology. The outcome of such analysis can be innovatively used, for example in helping the client or developer to model the cost for a future project from other similar projects.

# *APPENDIX I*

**Pre-Tender Health and Safety Plan for the  
Demolition of Blocks B and C and Construction  
of Piled Foundation**



## Appendix CT.H to the Conditions of Tender (Clause 6 of the Special Conditions of Tender)

### Pre-contract Health and Safety Plan

(This Pre-contract Health and Safety Plan will not form part of the Contract and is provided for information only to assist in the preparation of the Outline Safety Plan)

---

#### 1. GENERAL

##### 1.1 Document

This document merely serves as a guideline to the tenderers, for the preparation of the Outline Safety Plan for the design and construction of piling foundation system and the design of the pile caps and strap beams of the new Rehabilitation Block and demolition of the existing Staff Quarter Blocks B and C.

The health and safety considerations outlined herein have been included comprehensively in various parts of the tender document. This document therefore regards as a summary of the health and safety items, for which the tenderers would have been taken into accounts of.

##### 1.2 Commencement of Construction Works

The Contractor should not commence the construction works until he has adapted and developed his Safety Plan as stated in section 12 of this document. The Safety Plan should be submitted to the Architect or his representatives in sufficient time for their consideration.

##### 1.3 Programme

In preparing the detailed programme, the Contractor should allow for the adoption of safe working procedures and co-ordinate and rationalise activities to avoid uncontrollable hazards arising due to clashes of activities.

##### 1.4 Sub-Contractors, Suppliers & Designers

The Contractor should ensure his sub-contractors, suppliers and designers, etc. to comply with the relevant provision of the Particular Specification for Site Safety in the Contract.

##### 1.5 Liaison

The Contractor should liaise with the the Architect or his representatives as required under the requirements of the Particular Specification for Site Safety and in connection with the preparation of the Safety Plan.

## **2. PROJECT DESCRIPTION**

As stated in Specification Preliminaries.

## **3. INFORMATION REQUIREMENTS**

The tenderers should include the following information in the Outline Safety Plan.

### **3.1 General**

- A copy of his corporate Health & Safety Policy Document.

### **3.2 Management**

- Details of the personnel and systems to be put in place to prepare, manage, implement and monitor the Safety Plan for the project.
- Details of relevant qualifications and experience held by the persons nominated above, including recent health and safety education and training undertaken.
- Procedures for determining the competence of sub-contractors engaged on the project, whether employed by the Contractor directly or by others, to fulfil their duties under the Contract.

### **3.3 Programme**

- The Contractor should develop the Safety Plan within the first month after the commencement date, in order to ensure the set up of the site for the works to be carried out properly.

## **4. SITE CONDITIONS**

### **4.1 Site Location**

The site is located where the existing Block B, Block C and the open air car parking are presently stand. It is located on the Staff Quarters and Nurse Training School area of the Tuen Mun Hospital, which face onto Tsing Lun Road, Tuen Mun. The site is completely isolated from the Tuen Mun Hospital by Tsing Lun Road. The only pedestrian linkage is through the existing underground service tunnel, which runs in front of the existing Block A. The existing Block B and Block C are essentially two detached block of 17 storeys and 4 storeys high concrete buildings respectively, located on the North side of the Staff Quarters and Nurse Training School area. The rear elevation of the existing Block B is in close proximity of the Castle Peak Hospital and a small local village. To its southwest side is the 17 storeys high Block A, which has been newly refurbished during Phase I of this Redevelopment.

#### **4.2 Existing Traffic System and Restriction**

The site is only accessible through Tsing San Path, off Tsing Chung Koon Road. It should be noted that the path will be blocked for access during the two Saturdays and Sundays before and after Ching Ming Festival and Chung Yeung Festival. Works will be affected during the two Saturdays and Sundays as mentioned above. Contractor is advised to consult Ching Chung Sian Yuan for the temporary arrangement of the traffic during the foresaid periods.

The site has a retaining wall structure along the eastern boundary, facing Tsing Lun Road, where the KCRC Light Rail Transit track is located. Any access or loading and unloading are absolutely prohibited through this retaining wall structure.

It is also essential to note that the Block A on the Staff Quarters and Nurse Training School area is to be remained in normal operation, while the demolition and piling works is in progress.

Access for emergency service vehicles must be maintained at all times and agreed with the Hospital Administration and the neighbourhood.

#### **4.3 Site Use**

The present use is occupied by two blocks of reinforced concrete cross wall blocks. Block B is a 17 storeys high building and Block C is 4 storeys high. Block B is a mixed use block which consists of staff overnight dormitories and offices on its lower floors, whereas Block C is the minor staff quarters and storage rooms for the Hospital.

The foreground of the site is an open car park with a row of mature trees adjacent to the retaining wall along the site boundary facing Tsing Lun Road.

There is a shallow slope of about 7-4m high located at the rear of Block B.

#### **4.4 Existing Services**

Live services present beneath the site had been diverted or decommissioned by others before the commencement of the works. However, the Contractor will be required to detect, maintain or divert possible remaining live services during works. Service surveys and record searches have and will be carried out to enable the production of co-ordinated drawings.

The Contractor should exercise appropriate caution and carry out good practice measures of surveying the existing underground services before carrying out of any work. A safe system of work should be developed by the Contractor in control of the utilities work prior to starting on site.

Prior to the commencement of works the Public Utilities will need to be contacted individually in order to determine the locations of their services.

The existing drainage system should be scrapped off, except for the foul water last manhole "M" and soil water manhole "No. 21". They will be remained in operation. The drainage system for Block A had been diverted by others before the commencement of the works. However, the Contractor shall provide protection to those newly constructed manholes and associated drain pipes, leading from Block A to the last manholes.

### **4.5 Fire Precautions & Means of Escape**

Since Block A will remain in operation during the demolition of Blocks B & C and the piling works, the Contractor shall therefore require to observe the existing means of escape from the site and Block A. A separated escape route along the frontage of Block A has been designated for public access to Block A and this will also serve as the emergency escape route from the building. The 6m access road in front of Block A shall be the EVA. This shall be kept clear at all time.

The Contractor should prepare a detailed Fire Plan to highlight alternative means of escape and sequence of working in advance of any demolition or piling works which will affect the layout of the EVA and escape routes from Block A. The Contractor shall observe the Fireman's Access and the location of the Fireman's Lift of Block A and to ensure these will not be obstructed at all time. The hospital may supply to the contractor a set of plans of the property for that purpose but it will be for the contractor to update and amend the plans as necessary.

### **4.6 Occupation**

The existing Block A and the underground tunnel for pedestrians will remain in full operation.

### **4.7 Existing Ground Conditions**

Whilst ground investigation record of drill holes are available for inspection, the Contractor is required to install additional drill holes to identify the ground condition in order to obtain sufficient information for the piles design.

### **4.8 Adjacent Projects**

The Contractor should liaise and co-ordinate with any other parties carrying out works in the vicinity and with any others likely to be affected by the work on site. This may include, local residents, businesses and other construction projects.

The Contractor should develop a suitable system to enable those who may be affected by relevant works to be informed in good time before the works start, so they can make appropriate arrangement as necessary.

### **4.9 Light Rail Transit**

The KCRC Light Rail Transit runs in parallel with the Southern edge of the site. The closest track of the LRT is within 6m from the site's existing boundary wall. Works in relation to the hoarding construction and piling construction, located at the close proximity to the boundary wall, prior approval from the KCRC LRT will be required. The guidelines for the relevant training programme and the application procedures, as required by the KCRC LRT, is attached in Particular Specification PS.O.

## **5. EXISTING DRAWINGS AND INFORMATION**

### **5.1 Existing Drawings**

A selection of existing drawings of the site is available for inspection at the Architectural Services Department.

### **5.2 Information Available for Inspection**

The Architectural Services Department will keep and make available for inspection information regarding the type and location of utilities at their office, and the information are only for reference purpose.

## **6. THE DESIGN**

### **6.1 Principal Hazards Identified by the Project Team**

This section is to list those hazardous operations / hazards, design assumptions, of work sequences which may be a risk to construction workers' health and safety, and which cannot be avoided. It may not be a comprehensive list of every hazard that may be present, but rather those hazards that the designers consider most important. The list does not include commonplace site hazards which are deemed to be familiar to the average competent contractor and can be controlled by normal good site management practices.

A summary of Hazards Summary Sheets together with information sheets which provide more detail are provided in the Annex.

### **6.2 Contractor's Proposals**

The Contractor should take appropriate measures to eliminate or reduce and control the risks created by the hazards detailed in the Annex, in the Hazards Summary Sheets and throughout this document. Explanation of the proposed measures is to be included in the form of detailed method statements. Any other particular hazards in addition to those above are to be identified by the Contractor, who is to submit proposal as to how their associated risks may be controlled.

## **7. SITE ASPECT ELEMENTS**

### **7.1 Site Access and Egress**

- Site vehicular access are expected to be shared with the hospital staff and contractors (for other contract), through the only entrance at the end of Tsing San Path.
- Store materials and plant away from means of access for the general public and occupants.
- Remove rubbish and demolition materials regularly. Do not allow to accumulate on site, in particular, every floor including the roof.

## **7.2 Deliveries**

Access to the site is only from Tsing Shan Path, off Tsing Chung Koon Road. The access entrance and the EVA in front of Block A is to be kept clear at all time.

## **7.3 Emergencies**

Refer to section 7.2 above.

## **7.4 Location of Temporary Site Accommodation**

The Contractor is to make proposals for the provision and location of temporary site accommodation for his employees and other contractors for the duration of the works in accordance to the Building Ordinance CAP123, Building (Planning) Regulations, Part VII. Arch SD site accommodation are detailed in the "Particular Specification for Accommodation and Provisions for Clerk of Works, Building Services Inspectorate Staff and Resident Engineers".

Temporary site accommodation is to be located in a position so as not to interfere with access to and from the site nor access to and from the Works. Nor should it be in a position so that the neighbouring properties are overlooked.

The fire and emergency access must be maintained at all times.

## **7.5 Location of Unloading, Layout and Storage Areas**

The Contractor is to plan and co-ordinate the provision of unloading, layout and storage areas, to suit the methods of construction and work in progress, subject to the approval of the Architect or his representatives.

Materials are to be unloaded and stored in locations which will not in any way affect access or egress to the site nor the works. Initial assessment has indicated that the open space, at the existing open air car parking area would be used as the storage area for material. The setting up of hoarding will be required to take into accounts of this area.

A full safe system of work will be expected for carnage on site which will take account of placements of plant/equipment in relation to underlying structures and utilities and protecting the Hospital staff during the loading and unloading operations.

The Contractor should take into considerations of the existing structure of the pedestrian tunnel along the pavement of the existing Block A and avoid placing excessive loading on pavement, which will consequently affect the structure of the tunnel.

## **7.6 Traffic and Pedestrian Routes**

The road and public footpaths are to be kept open at all times. All necessary signage and barriers are to be put in place to protect pedestrians at the site entrance and access and egress points.

The access from and to the pedestrian underground tunnel is to be kept open at all times.

## **7.7 Special Consideration to Welfare Facilities**

The Contractors should be fully conversant with the tender documents and will be required to develop proposals to respond to the health and safety requirements in this section.

Provision of site welfare facilities to be in accordance to the requirements set out in the Specification Preliminaries and the Particular Specification for Site Safety.

## **7.8 Environment**

### **Noise:**

Due to the sensitivity of the neighbourhood, the Contractor should provide provisions against noise and vibration by controlling it at source by fitting silencers and dampers where possible. Do not keep machinery running unnecessarily.

### **Pollution:**

Take precautions to protect against pollution of water courses and the air. Damp down the ground to ensure that dust is not generated. Ensure that during the demolitions all dust is kept to a minimum by damping down at regular intervals.

Provide personal protective equipment including head protection, ear protectors for all operatives involved in noisy working, eye and face protection, respiratory protective equipment, general and specialist clothing, gloves, safety footwear.

### **Waste Disposal:**

Refer to Particular Specification for the disposal of the toxic waste.

## **7.9 Security**

- Ensure that all ladders and other means of access to scaffolding are removed at the end of each working day and locked in a secure area.
- Maintain a daily log of all site operatives and visitors to record time of arrival to site and departure from site.
- Issue all operatives with suitable identification badges to be worn and displayed at all times whilst on site.
- Lock away in secure storage flammable or dangerous substances.
- Immobilise plant at the end of each work period.

## **7.10 Safety**

- Ensure that all employees are aware of the safety policy and put into place arrangements to ensure that all visitors and workers new to the site are aware of the site safety provisions.
- Portable electric tools and equipment are to be supplied from 110V transformers or have special measures taken to protect them from mechanical damage and wet conditions.
- Locate underground electricity cables, mark and take precautions to avoid.

- Ensure that cartridge operated tools are operated by trained personnel and in accordance with the maker's instructions that the gun is cleaned regularly and kept in a secure place when not in use.
- Ensure that there are chutes for waste to avoid materials being thrown down.
- Ensure waste material is removed regularly and that the site is kept tidy and materials stored safely.
- Ensure that all personnel can reach their place of work safely and that there are adequate barriers to stop falls from open edges of the ground trenches.
- Provide adequate artificial lighting when work is carried out after dark on the site ground.
- Ensure that ladders are in good condition and that they are secured either at the top or bottom to prevent slipping. The ladders are to rise by at least 1.07m above their landing place.
- Provide adequate propping to the existing structure while the demolition is in progress, to avoid sudden collapsing. Propping, temporary shoring and the excavation plan should be submitted, in accordance to the Particular Specification requirement in good time for approval, before the commencement of such works.
- Provide adequate scaffolding to carry out the works ensuring that there is proper access, all uprights provided with base plates, it is secured to the building, fully board working platforms, provide adequate guard rails and toe boards to every side which a person can fall more than 1.98m, that where loaded with materials, they are evenly distributed, where the scaffold is near the boundary then debris netting should be incorporated, the scaffold is inspected on a weekly basis and after bad weather and that the results of the inspection are recorded and signed by the person who carried out the inspection.
- Provide the right number and type of fire extinguishers in positions where they may be needed. Ensure all fire extinguishers are properly maintained and inspected and a record of inspection certified on the appliance.
- Ensure that there are adequate escape routes and that they are kept clear at all times.

## 8. OVERLAP WITH CLIENT'S UNDERTAKING

### 8.1 Occupiers Activities

- Block A of the Staff Quarters and Nurse Training School will remain in full operation during the demolition and piling works.
- Part of the Block A will be used as the Administration Office, while several floors will be dedicated as overnight and call rooms for the healthcare staff, during the demolition and piling construction.



## **8.2 Works at High Level**

- Provide temporary protection to areas below to prevent injury from falling materials.

## **9. TEMPORARY WORKS**

### **9.1 Scaffolding**

- The erection of a covered walkway along the narrow foot path between the close proximity of the Castle Peak Hospital and Block B of the nurse quarters is envisaged. Moreover, the Contractor shall be required to set up catch platform along the perimeter of Block B, for the carrying out of the demolition works.
- Scaffolding and screen with demountable noise barrier are required to be provided at least one storey above the working level during the demolition process in order to provide a better control on the noise and dust. The Contractor is required to ensure that the supports to the scaffolding and screen are properly designed for, installed and maintained throughout the demolition works.

### **9.2 Access Generally**

- Provide safe access for operatives in the form of ladders/stairs/hoists on the scaffold etc.
- Provide temporary barrier rails to all open roof edges and large openings of each floor.
- Provide steel hoarding and catch fans for the demolition of the concrete canopy and the taking down of the external wall finishes.
- Provide safe access for the pedestrians and workers on site and the shared access, in form of temporary covered walkway, temporary lightings, temporary traffic diversion signage and temporary traffic lights with auto- and over-riding controls.

## **10. SITE RULES**

### **10.1 Permit to Work Requirements**

The Contractor is responsible for consulting statutory authority as required by the various Regulations and standards with regards to contamination. The Contractor should carry out risk assessments related to the works and establish rules and procedures for health and safety issues arising. The site rules should include reference to the following issues:

- Institute a "hot work" permit system in respect of metalwork flame cutting, site welding, asphalt repairs and the like.
- Control working in confined spaces.
- Control of persons gaining access to the site.

- Briefing of persons gaining access to and working on the site.
- Prohibition of Smoking and Alcohol
- Personal hygiene and protective clothing
- Radio and audio equipment
- Emergency procedures
- Personal Protective Equipment (PPE)
- Site induction procedures with specific reference to Fire & Emergencies, Vehicles on Site and Use of Harnesses

The arrangements will be controlled and monitored by the Contractor to meet changing needs of the site personnel as appropriate to the site operations.

### **10.2 Injury**

- Maintain proper first aid facilities administered by qualified personnel.
- Report accidents, ill health and dangerous occurrences to the Architect and, where applicable, to the ETWB.

## **11. METHOD STATEMENTS**

### **11.1 Scaffolding**

The following are to be considered before implementation of the associated works:

- Provide general arrangement drawings for scaffolding to all elevations detailing bridging and protection over means of ingress and egress, and the like; ties into existing structure; protective works to public highways and footpaths; hoist arrangement.
- Disposal of rubbish and demolition materials from site.

### **11.2 Hoarding**

Method Statements should be submitted for any proposals for the erection or proposed changes to the layout and design of scaffoldings and hoardings, in particular, for the erection of hoarding along the boundary with LRT.

### **11.3 Demolition Works**

Method statements for demolition works should be submitted with particular attention to enhance safety and minimise noise disturbance to the neighbour. In particular, the following special structures should be demolished/retained with well-planned method statements to address on all safety concerns:

- a. Post-tensioned prestressed structure at 3/F of Block B;
- b. Cantilevered canopy at 1/F of Block B;

- c. Underground services tunnels and pile caps;
- d. Existing retaining walls at G/F of Block B, which are to be retained; and
- e. Architectural r.c. fins / features at external walls.

#### **11.4 Piling Works**

Method Statements for pile installation should be submitted with particular attention to enhance safety, minimise nuisance from noise and vibration and the interfacing with demolition activities.

#### **11.5 Site Logistic**

Contractor shall consider the access issues and festivals impact.

#### **11.6 Temporary Drainage Diversions**

Site drainage plan and measures to prevent polluting the drainage system, in accordance to the EPD requirements are to be ensured.

#### **11.7 Protection**

- Protection and monitoring measures to the adjacent building and facilities should be addressed.

### **12. CONTINUING LIAISON**

#### **12.1 Procedures for the Health and Safety Implications of Contractors' Designs**

The procedures for consideration and evaluation of the health and safety implications of contractor designed elements of the works must follow the recognised principles of prevention and protection and take account of the issues highlighted in this outline of the Health and Safety Plan. The Contractor is to provide details of the hazards, and associated risk assessments to the Project Team before execution of the work.

Hazards arising from the use of temporary works to be identified and risk assessed by the Contractor in advance of the execution of the work.

Suitable and sufficient information to demonstrate that health or safety issues have been adequately considered.

##### **Risk assessments**

A list of health and/or safety hazards identified which cannot be designed out.

A list of any materials or substances which are specified or inherent in the design which are potentially hazardous to health and/or safety.

### **12.2 Procedures for Dealing with Design Changes**

Details of any re-design found to be necessary, together with details of the hazards and risk assessments should be issued in ample time before execution of the work. The Contractor is requested to submit the assessment to the Architect or his representatives for approval and the subsequent incorporation into the Safety Plan.

### **12.3 Unforeseen Eventualities**

The following action is to be taken in the event of unforeseen eventualities arising during the construction stage of the project which require significant design changes, or affect the resources required to carry out the work without risk to health and/or safety, or have other health or safety implications.

The Architect or his representatives and, where possible, the Contractor are to be advised as soon as possible.

Full details of the relevant health and safety issues involved are to be reviewed with the Safety Officer and the Contractor as soon as possible.

Full details of any revised designs, risk assessments and identified hazards and/or hazardous materials and substances are to be issued to the Safety Officer and the Contractor in sufficient time to allow for the revision of the Health and Safety Plan and notification of all persons affected by the health and/or safety implications of the changes prior to the commencement of the affected works.

### **12.4 Safety Plan**

Modify the Safety Plan to reflect variations in design or changes in site conditions and liaise with the Safety Officer.

The Contractor should develop this Pre-contract Health and Safety Plan so that it:

- a. Incorporates the Contractor's approach to managing the construction work to ensure the health and safety of all persons carrying out the construction work and all persons who may be affected by their work.
- b. Includes the risk assessments prepared by all contractors.
- c. Includes the arrangements for ensuring that, where appropriate or specifically requested, all contractors / sub-contractors prepare suitable and sufficient method statements for their construction works which incorporate adequate measures for ensuring the health and safety of all persons who may be affected by these works.
- d. Incorporates the common arrangements for site welfare, statutory notices and registers etc.
- e. Includes the site rules to be adopted for controlling the risks to health and safety during the construction phase(s) or the project.

- f. Includes reasonable arrangements for monitoring compliance with health and safety legislation and site rules.
- g. Includes reasonable measures to ensure co-operation between all contractors and sub-contractors in respect of health and safety provisions and prohibitions.
- h. Includes the steps to be taken to ensure that only authorised persons are allowed into any premises or parts of the site / premises where construction work is being carried out.
- i. Includes arrangements for emergency procedures as required under the Health and Safety Regulations and the arrangements for displaying notices relating to these procedures.
- j. Includes arrangements for ensuring that, so far as is reasonably practicable, every contractor and sub-contractor is provided with comprehensible information about the risks to health and safety of that contractor / sub-contractor, or of any employees or other persons under their control, arising out of the construction works, including the emergency procedures.
- k. Includes details of the arrangements for ensuring, so far as is reasonably practicable, that the employees or other persons under the control of any contractor / sub-contractor, and any visitors to the site, receive adequate information about the risks to their health and safety arising out of the construction works and, where necessary, adequate training to carry out their work in a safe and healthy manner.
- l. Includes arrangements for providing all persons at work on the site and visitors to the site with the opportunity and means of discussing and offering advice on health and safety issues relating to the construction works.
- m. Includes arrangements for the reporting of any accidents, injuries or dangerous occurrences.
- n. Can be modified as the work proceeds to take account of any information received from contractors / sub-contractors, any experience gained during the course of the project or any changes necessary as a result of unforeseen circumstances or alterations to the design.

### **12.5 Site Liaison**

Liaise with all other contractors and implement any agreed changes to the Safety Plan arising from such liaison. Set up regular training for all operatives including induction training for all staff upon arrival to site.

### **12.6 Health and Safety File**

Provide the Project Team with any relevant information which the contractor believes should be incorporated into the Health and Safety File.

### **12.7 Design Development**

Provide the Project Team with all design information prepared by sub-contractors; arrange liaison meetings with sub-contractors to discuss and review health and safety issues arising from the sub-contractors' designs.



# CDM

## *WORKED EXAMPLE No. 2*

*Landslip Prevention Work to Slope  
No.15 NW-B/C66 at Upper Firing Range,  
Police Training School, Aberdeen*

Geotechnical Engineering Office,  
Civil Engineering and Development Department



## CONTENTS

---

<b>1. Project Information</b>	<b>43</b>
1.1 Scope of Works	
1.2 Project Location	
1.3 The Team	
<b>2. Site Environment and Nature of the Works</b>	<b>44</b>
2.1 Site Environment	
2.2 Nature of the Works	
2.3 Liaison Activities	
<b>3. Identification of Special Hazards</b>	<b>47</b>
3.1 Improvement in Design under CDM	
3.2 Impacts Summary	
<b>4. Documentation</b>	<b>51</b>
4.1 Highlights	
4.2 Pre-tender Health and Safety Plan	
<b>5. Views</b>	<b>53</b>
5.1 Key Points to Note	
5.2 Improvements Derived	
Appendix I - Design Drawings	55
Appendix II - Pre-tender Health and Safety Plan	58

## 1. Project Information

### 1.1 Scope of Works

The proposed landslip preventive works mainly comprise installation of soil nails and prescriptive raking drains, repair of the existing drainage system, landscape treatment of the slope, construction of maintenance access as well as infill of voids behind a bullet catcher at the slope toe for Slope No. 15NW-B/C66 under the in-house Remeasurement Contract No. GE/2003/01 (Drawing Nos. C66a, C66b and C66c in Appendix I refer).

### 1.2 Project Location

The site of the project is at Slope No. 15NW-B/C66 at overseeing the Upper Firing Range, Police Training School at Aberdeen.

### 1.3 The Team

The organization of in-house design team of a slope-upgrading project is as follows (with rank in brackets):

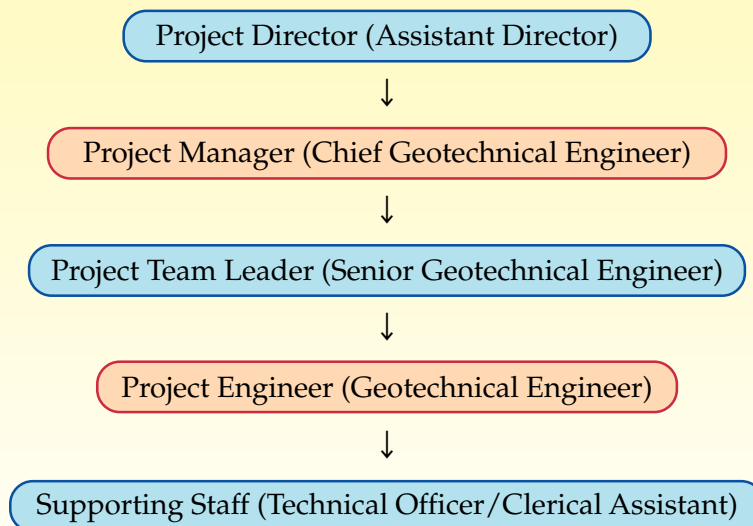

## 2. Site Environment and Nature of the Works

### 2.1 Site Environment

Slope 15NW-B/C66 is a 34-metre high maximum and 110-metre long man-made cut slope situated above the southeastern side of the Upper Firing Range inside the Police Training School (PTS). The slope is divided into five batters and each batter stands at approximately 40° to 50°. The bottommost batter of the slope is covered with shotcrete and the remainder batters are heavily vegetated (Plate 1). Further to the

west is a natural stream course from Nam Long Shan above. The aerial ropeway for cable car of Ocean Park is 180 metres to the east of the slope (Figure 1). The critical cross section 4-4 of the slope is shown in Figure 2.

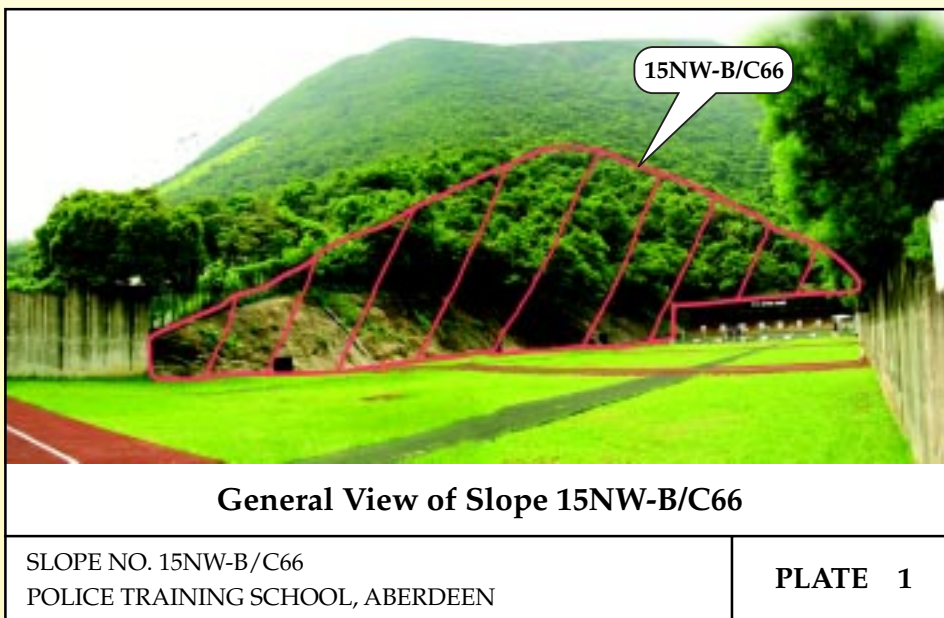

Plate 1 - General View of the Slope

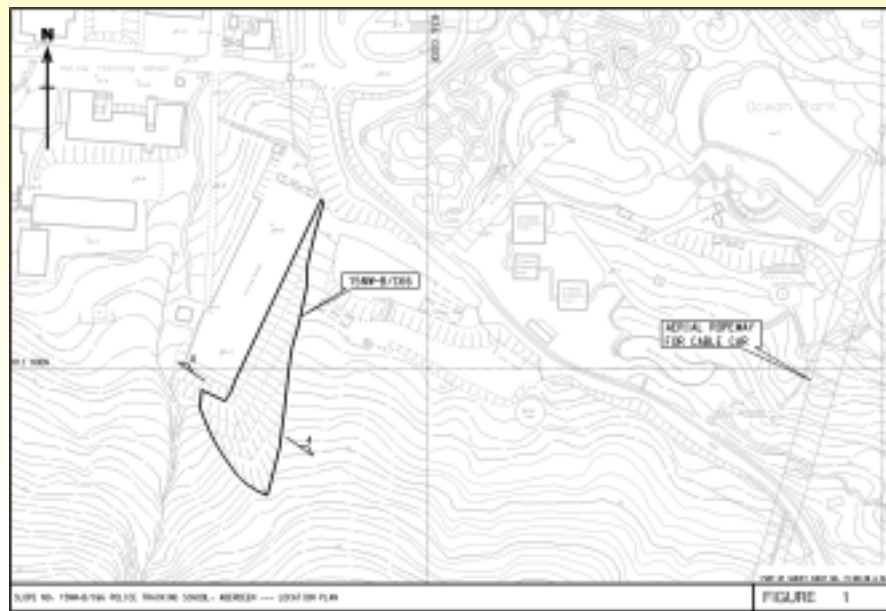

Figure 1 - Location Plan

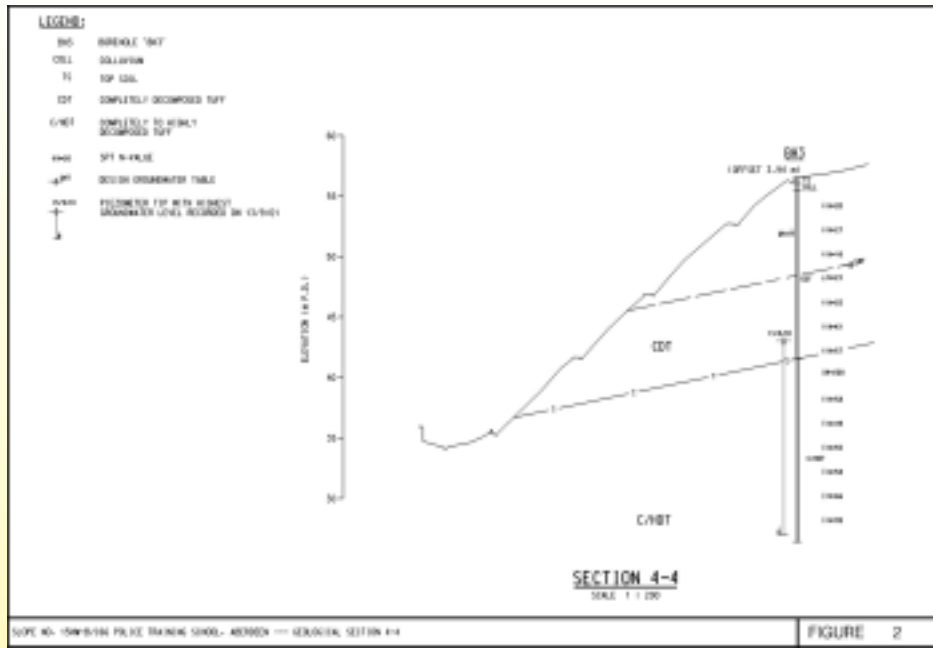

Figure 2 - Geological Section 4-4

The Upper Firing Range at the slope toe is frequently used by the Hong Kong Police Force (HKPF) as well as Customs and Excise Department for the purpose of firearms training. Besides, the range is the only suitable site for long barrel firearms training of the PTS. All site works shall be suspended during the firearms training. The detailed safety requirements and the frequency of firearms training have been discussed and agreed with PTS.

The existing services comprise the public announcement system along the slope toe, soft sub-soil drainage pipes underneath the platform of Upper Firing Range, and salt water mains adjacent to the northern end of slope.

The sole vehicular access to the Upper Firing Range is Range Road (Figure 3).

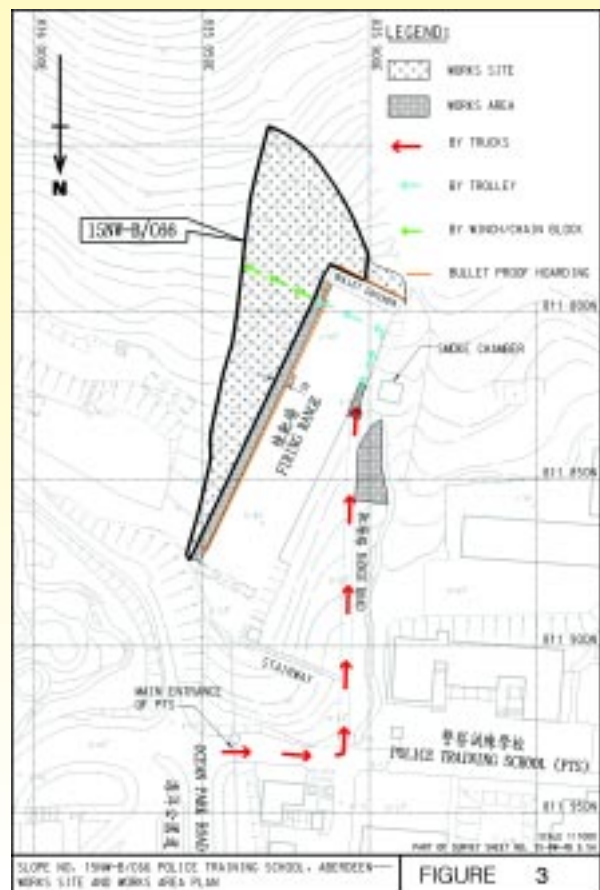

Figure 3 - Works Site and Works Area Plan

This road is closed during firearms training of PTS. There is a smoke chamber at the end of Range Road (approximate 30 metres to the west of the slope). As advised by PTS, the smoke chamber is currently used for storage of ammunitions.

### 2.2 Nature of the Works

The works is fairly standard landslide preventive measure. A working platform is to be erected against the slope face where the work is to be carried out, initially. The slope is trimmed as necessary, and pneumatic drills are employed to form long holes into the slope. 'Soil nails' (actually steel reinforcement bars) are inserted, together with a grout tube into the hole, with cement grout subsequently pumped through the tube. Grout should reach the bottom of the hole and the hole is fill to the top. When grout is seen oozing from the opening, the hole is filled completely. When the grout hardens, pull out test is conducted to a number of nails to verify the pull-out capacity. Nail heads are then constructed (see special consideration about ricochet below), and the slope is covered with erosion control mat, and hydroseeded. The working platform may be moved (taken down and re-erected as needed) around the slope to facilitate phased construction sequence of works.

### 2.3 Liaison Activities

Since the slope lies on the campus area of PTS, regular contact with the PTS and its maintenance agent, Architectural Services Department (ArchSD), has to be maintained at different stages of the project. Liaison activities with the PTS, the ArchSD and the other parties concerned are as follows:

#### **Utility Undertakers**

At the very beginning of the design stage, various utility companies and Government Departments are to be requested for location of underground services in the vicinity of the site. The utility plans are then studied to determine if the upgrading works would affect or be affected by any nearby utilities and to allow time for diversion of the utilities if required. For instance, PTS notifies that there are soft sub-soil drainage systems buried underneath the whole firing range. Such constraints are specified in the drawings and the Particular Specifications such that passage of site vehicles and placement of heavy machinery on that area are prohibited.

#### **District Lands Office**

Before commencement of the site works, access permit and Temporary Land Allocation for the Works Site and Works Area should be obtained from District Lands Office and PTS for implementation of the works.

Since the slope is immediately adjacent to the Firing Range of PTS, which is the only suitable site for long barrel firearms training, no site work is allowed during the training on the grounds of safety and security. In order to facilitate the site works, negotiation with PTS was initiated to rearrange the firearms training programme to provide longer continuous periods for the contractors to carrying out the LPM works.

### **Transport Department**

Although prolonged closure of vehicular access in PTS is not necessary for the proposed design option, temporary closure of Range Road adjacent to the firing range is inevitable for the purpose of loading and unloading of construction materials as well as ingress and egress of site vehicles. Transport Department and PTS were consulted on the proposed temporary traffic arrangement, and their requirements were then incorporated into the Particular Specifications. For example, it was stated in the Particular Specifications that the Contractor should maintain sufficient width of Range Road to allow a medium size police vehicle to pass.

### **Other Relevant Parties**

The project plan and details of the proposed works were circulated to relevant government departments for consultation so that the upgrading works fulfill the needs on future development, and meet environmental, traffic, safety, maintenance as well as landscaping requirement.

## **3. Identification of Special Hazards**

### **3.1 Improvement in Design under CDM**

The essence of CDM is to address at the design stage by the designers all hazards that may be encountered during construction and subsequent maintenance of the project, particularly for aspects related to safety, environmental protection, buildability and maintainability. Some of the improvements made in the design are discussed below.

#### **Phased Construction**

In view of the need to maintain regular firearms training and safeguard the workers during such training, the proposed LPM works are designed to be carried out in 8 phases to suit the firearms training schedule. During the option assessment meeting, a total of 3 options have been considered, namely cutting back (Figure 4), retaining

## WORKED EXAMPLE NO. 2

wall with rockfill (Figure 5) and soil nailing (Figure 6). Soil nailing was finally selected as the best option because the works could be easily split up into components and carried out in a sequence compatible with the firearms training programme.

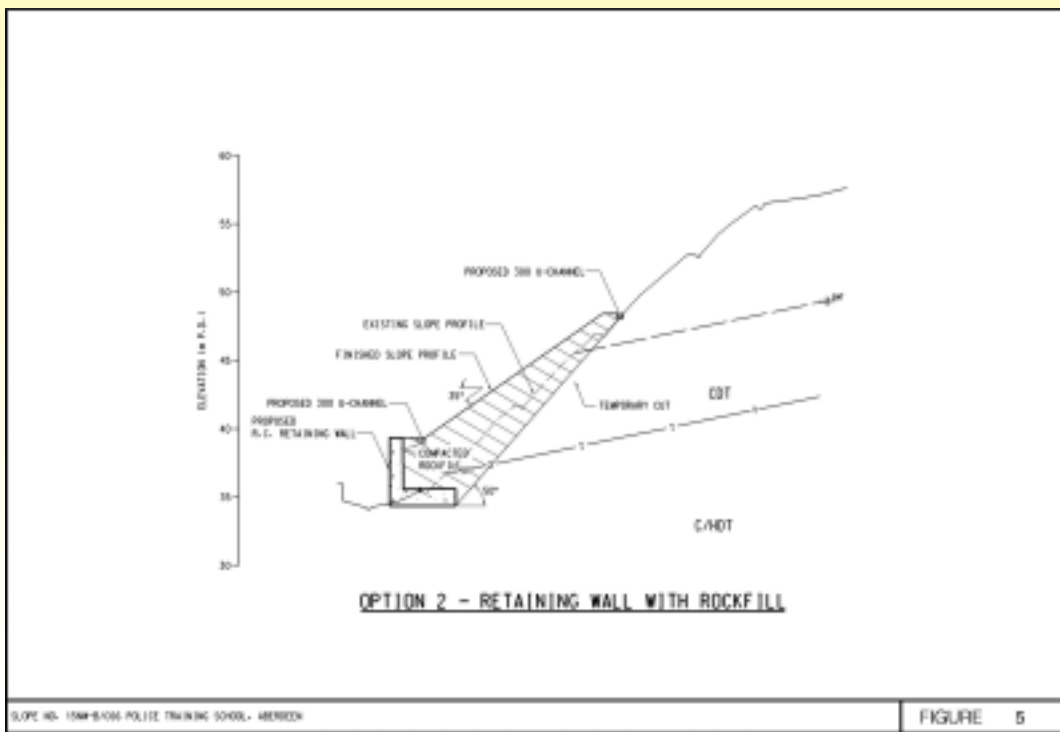
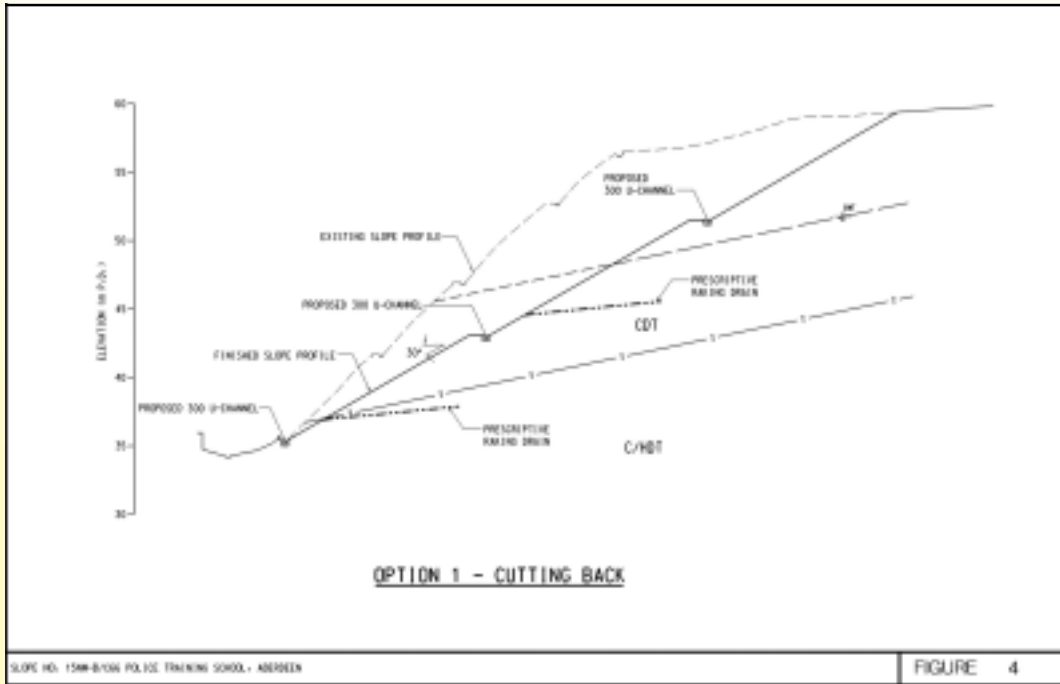



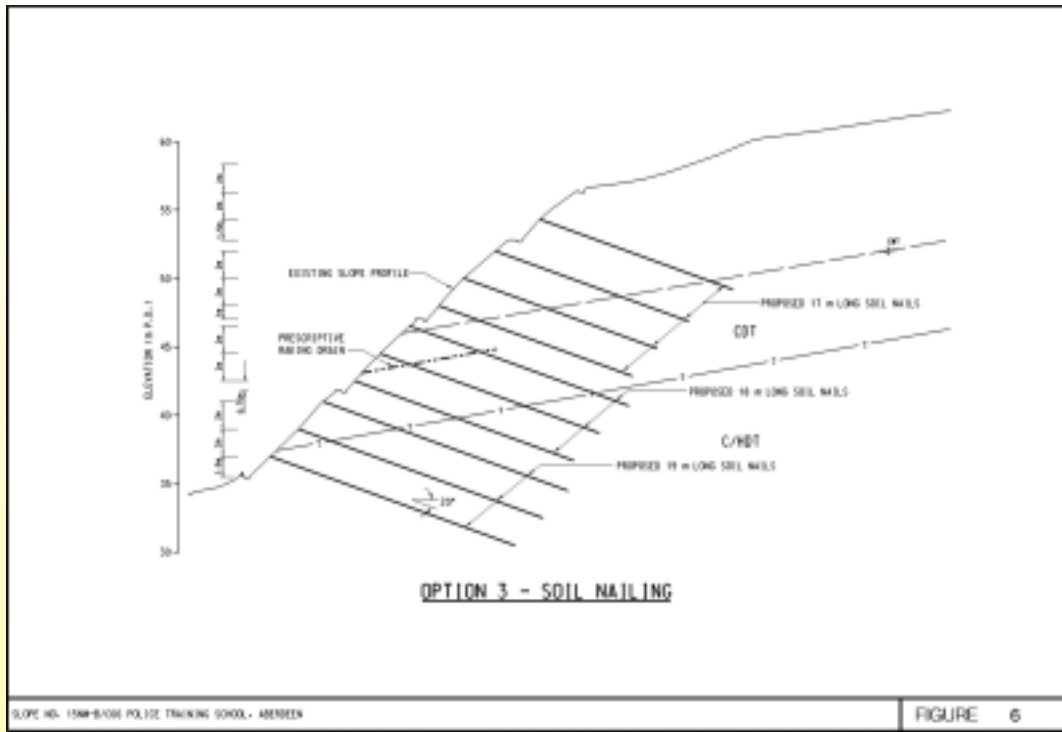

Figure 6 - Option 3 - Soil Nailing

### Mitigation of Effect on Ocean Park Visitors

As mentioned in Section 2.1, the aerial ropeway for the cable car of Ocean Park is 180 metres to the east of the slope. The potential environmental impact of the proposed works to the visitors in the cable car has been investigated. It is considered that the noise generated by the proposed works would have minimal effect on Ocean Park visitors while the dust generated might be a potential impact because the firing range is visible from the route of cable car (Plate 2).

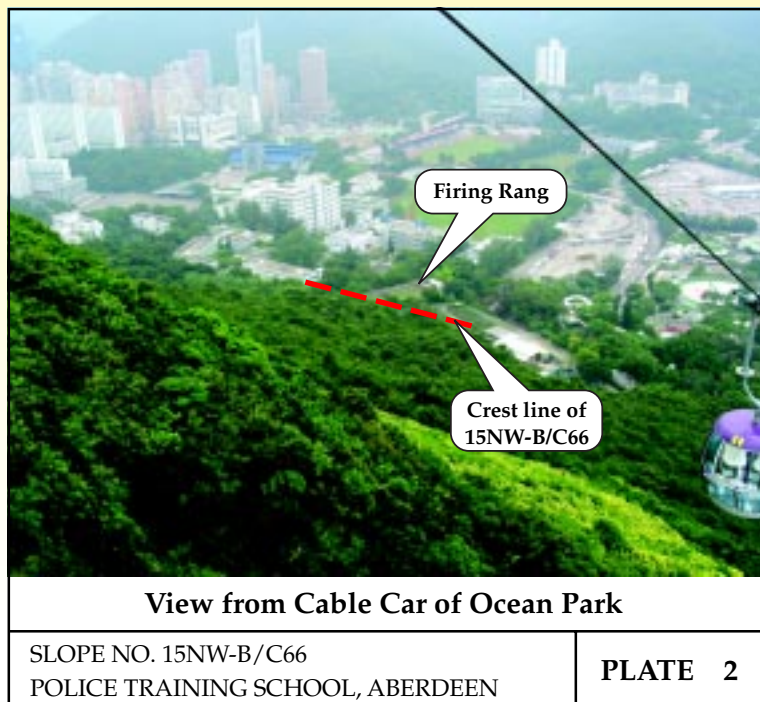

Plate 2 - View from Cable Car of Ocean Park

In order to contain the dust, typical mitigation measures such as using styrofoam board to cover drillhole during the drilling process and confining the dust by shielding the working scaffolding with tarpaulin sheet will be adopted. A tailor-made sprinkler will also be used to further suppress the dust during construction, if necessary.

### Prevention of Ricochet

Safety considerations are incorporated into the detailed design of upgrading works, such as erection of a bullet proof hoarding around the site and the use of special soil nail heads with soft cover in lieu of concrete soil nail heads to avoid the danger of ricochet.

### Site Access

Proper access routes to the Works Site and Works Area have been identified by the designers. Construction materials and plants may be delivered by trucks from main entrance of PTS to the entrance gate of firing range via Range Road (Plate 3). Materials may first be stockpiled on the Works Area adjacent to the entrance gate. To avoid damage of sub-soil drain underneath the platform of firing range, passage of truck on the range is therefore strictly prohibited. Trolley may be used instead on the range to deliver materials and plants. The Contractor may winch the components of drilling rig from the slope toe to the working platform on the slope surface by using chain block.



Plate 3 - Range Road

### 3.2 Impacts Summary

A Work Impacts Mapping Summary, which records all hazards considered and mitigation measures proposed by the designer, is prepared at the design stage. Some of the hazards that have already been addressed fully by the designer at the design stage together with the unresolved hazards to be dealt with by the tenderers in their Outline Safety Plan (OSP) or to be addressed by the Contractor in his method statement during construction are as Annexes to Appendix II (Pre-tender Health and Safety Plan).

## 4. Documentation

### 4.1 Highlights

For the pilot project under CDM, the considerations by the designers in resolving site specific hazards at the design stage are as follows:

- Bullet-proof hoarding is specified to avoid damage of Contractor's properties on site and danger of ricochet;
- Sizing of soil nails has been carefully considered for aspects of buildability. The reinforcing bars are scheduled to provide lengths and diameter of manageable size;
- Soil nails are positioned at appropriate locations such that the root systems of existing mature trees are not damaged;
- Sufficient working area is provided to the Contractor;
- Recessed soil nail heads are adopted to prevent ricochet;
- Erosion control mat is applied to the slope surface to prevent surface erosion due to discharge of raking drains or during establishment period of vegetation;
- Hydroseeding is used to reduce the visual impact of the proposed works; and
- Appropriate maintenance programme including flushing of raking drains and establishment of vegetation on slope will be developed with PTS and ArchSD at a later stage.

The unresolved hazards to be addressed by tenderers in their OSP at the tender stage are as follows:

- Hazards associated with major site activities (e.g. temporary traffic arrangement, soil nailing, etc.);

- Improper handling of ammunition discovered on site;
- Unauthorized entry;
- Safety and health hazards related to soil nailing or works on sloping ground: falling objects, falling from height and manual handling; and
- Noise and dust.

During construction stage, the Contractor shall provide the following detailed submissions regarding the items listed above and in particular those unresolved hazards pointed out below:

- Detailed method statement should cover, without limitation, the following issues:
  1. Temporary traffic arrangement;
  2. Removal, storage and reinstatement of the public announcement system;
  3. Protection of the existing "REGAPOLE" rubber ground sheets and buried sub-soil drain at the firing range;
  4. Soil nailing;
  5. Erection of working platform;
  6. Hydroseeding;
- Construction sequences;
- Construction details including proposed footing details of bullet proof hoarding;
- Risk assessment of key site operations (e.g. mobilization of heavy objects by manual handling, risks of the works imposed to the smoke chamber, etc.);
- Safety and Health Training Plan (tailor-made safety training schedule for site personnel);
- Noise monitoring programme; and
- Temporary drainage proposal.

### 4.2 Pre-tender Health and Safety Plan

During the tender document preparation stage, a Pre-tender Health and Safety Plan is to be compiled (see Appendix II). The purpose of this Plan is to highlight the main health and safety, environmental, buildability as well as maintainability issues in connection with the works, though there may be other hazards, which are so far not apparent and therefore not covered in this Plan. Though this Plan does not form part of the Contract, it will be attached as an Appendix to the tender documents as a reference for tenderers in preparing their OSP. The Contractor should address in the

OSP all hazards and associated risks arising from design, construction, commissioning and maintenance of the project for which the contractors are responsible.

## **5. Views**

### **5.1 Key Points to Note**

The Project Engineers play a vital role in ensuring the smooth execution of CDM under the LPM Programme. They should pay particular attention to ensure all parties concerned are fully consulted on the aspects of utilities, land matters, future development, traffic arrangement as well as future maintenance requirements and incorporate all these comments into the final design.

Since CDM is a rather new approach, the Project Engineers should make reference to relevant publications to get familiar with CDM. Because many activities recommended under CDM are already inherent in the current LPM design practice, it should not be too difficult for a competent designer to grasp the essence and principles of CDM.

Generally speaking, hazards can be divided into three categories, namely: general, standard and specific. In order to avoid duplication of effort, Project Engineers should focus on those site specific hazards for each particular project under CDM. The general hazards that are common in all types of civil engineering works and the standard hazards associated with all LPM works should be dealt with at a departmental level as appropriate.

Sufficient time should be allowed for each project stage so that CDM can be satisfactory implemented. For instance, tenderers may find it very difficult to prepare the OSP that can fully address the requirements as stipulated by the designers in the Pre-tender Health and Safety Plan unless sufficient time is allowed for the tender preparation stage.

### **5.2 Improvements Derived**

The improvement in the LPM works under CDM is multi-fold, namely: potential savings in whole-life costs (including for example capital, maintenance, management, operating and disposal costs), advancement in design practice to mitigate safety and health hazards, and handover of design information in a more systematic manner to the parties concerned.

Implementation of CDM aims at tackling common problems in the construction industry like high site accident rate, unsatisfactory environmental performance, and poor buildability as well as maintainability, by encouraging considerations of the hazards related to these aspects at the planning and design stage. Since slope upgrading options and design details are still open at the design stage, designers can make significant contribution to eradicate, resolve or mitigate any potential hazards induced by the project with far less price to pay as compared with the situation when they are dealt with at the construction stage. Though extra resources are spent on provision of measures against project hazards, the intangible cost savings during construction and future maintenance of LPM works would be highly likely to compensate these expenses. A safer and environmentally friendlier LPM design will also reduce the number of site accidents and enhance the value of LPM works to the benefit of all concerned.

Application of CDM encourages designers to take a more active role in enhancing the safety and health, environmental protection, buildability and maintainability of LPM works. By following the principles of CDM, the designers shall take steps to minimize the hazards in the detailed design and to provide mitigation measures to the unavoidable hazards. In addition, CDM encourages designers to build in design elements that cover the safety and convenience of the maintenance parties in the project. Through this process innovative design may also evolve.

Due to high-risk nature of LPM works, many hazards identified by the designers can only be dealt with during construction. CDM requires the unresolved hazards to be included in the tender documents (i.e. Pre-tender Health and Safety Plan), so as to let the potential contractors to be fully aware of the unsolved risks and take them into considerations when preparing their tender submissions. As safety and health considerations are properly documented throughout the design process (e.g. hazards are listed in the Works Impact Mapping Summary), it will ensure all those concerned to have a clear picture of the site specific hazards that need to be taken care of during the construction stage as well as during the design life of LPM works.

# *APPENDIX I*

## **Design Drawings**



### APPENDIX I - DESIGN DRAWINGS

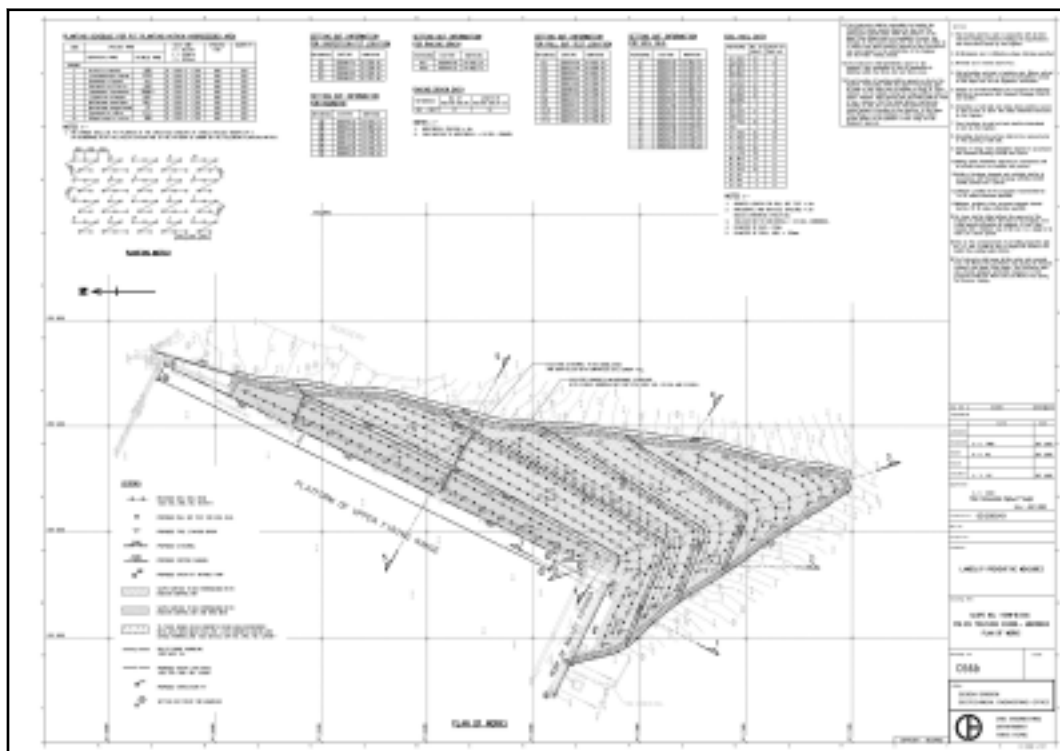
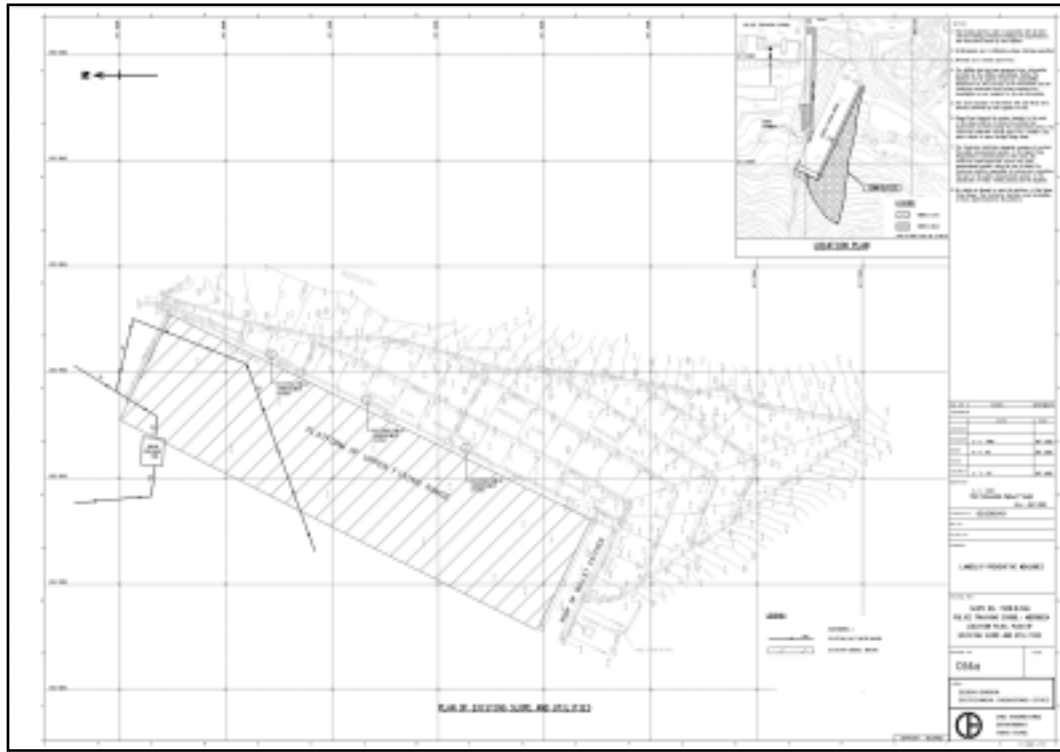

Landslip Prevention Work to Slope No.15 NW-B/C66  
at Upper Firing Range, Police Training School, Aberdeen

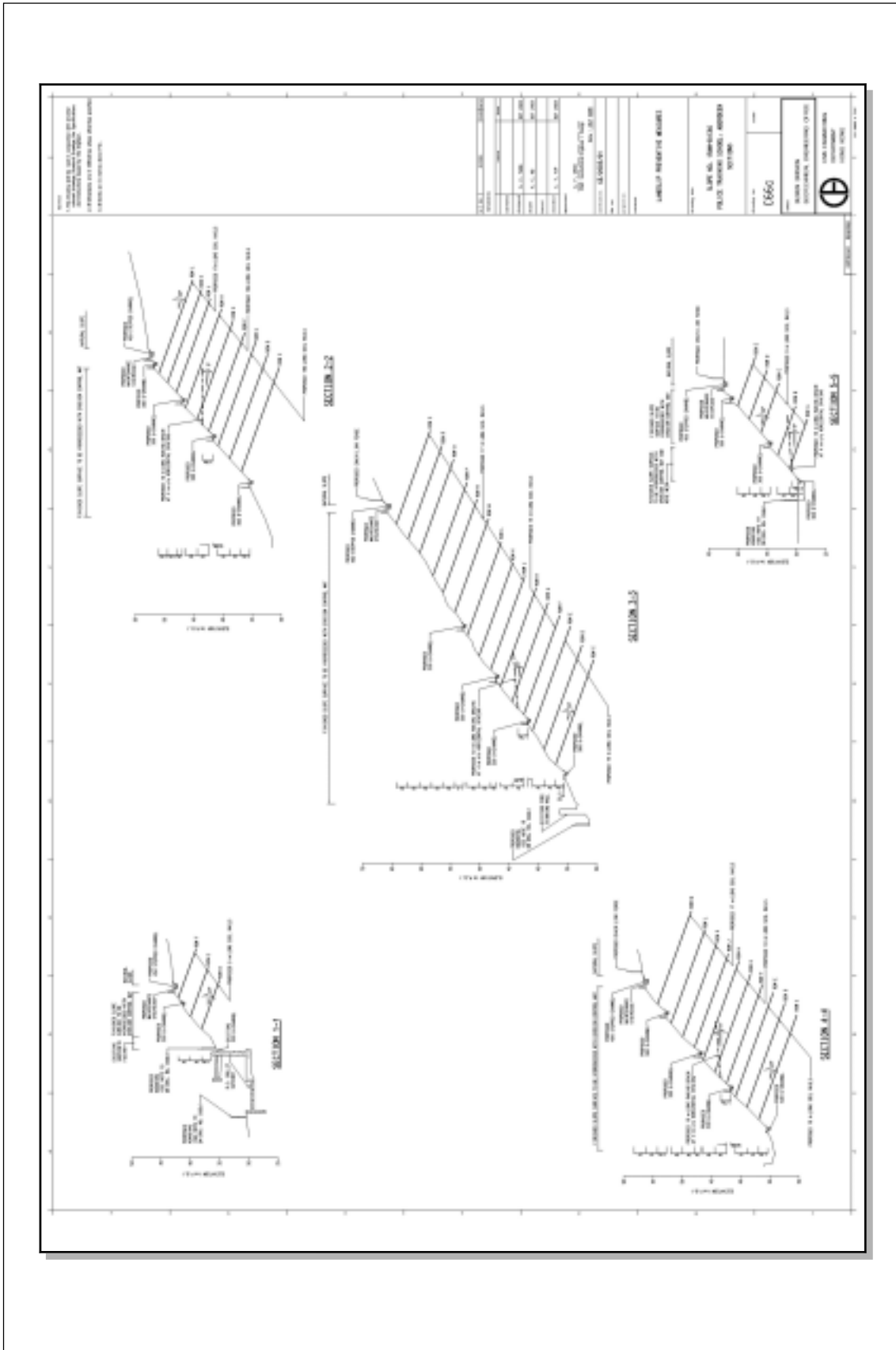

# *APPENDIX II*

## **Pre-tender Health and Safety Plan**

## APPENDIX II - PRE-TENDER HEALTH AND SAFETY PLAN

### Appendix II to Special Conditions of Tender Pre-tender Health and Safety Plan

(This Pre-tender Health and Safety Plan will not form part of the Contract and is provided for information only to assist in the preparation of the Outline Safety Plan)

---

### Contract No. GE/2003/01 Slope No. 15NW-B/C66, Police Training School, Aberdeen Pre-tender Health and Safety Plan

#### 1. NATURE OF THE PROJECT

##### 1.1 Name of Client

Systematic Identification of Maintenance Responsibility (SIMAR) report dated 2 February 1998 confirms that Hong Kong Police Force (HKPF) is responsible for the maintenance of slope 15NW-B/C66. Architectural Services Department (ArchSD) is the maintenance agent of HKPF.

The Design Division and the Works Division of the Geotechnical Engineering Office, Civil Engineering Department is responsible for the design of landslip preventive works and management of the works contract respectively.

##### 1.2 Location

Slope 15NW-B/C66 is a man-made cut slope situated above the southeastern side of the Upper Firing Range inside the Police Training School (PTS). Further to the west is a natural stream course from Nam Long Shan above. The aerial ropeway for cable car of ocean park is 180 m to the east of the slope.

##### 1.3 Nature of Slope Upgrading Works

The proposed landslide preventive works of the slope mainly comprise installation of soil nails and prescriptive raking drains, repair of the existing drainage system, landscape treatment of the slope, construction of maintenance access as well as infill of voidages behind the bullet catcher (Drawing Nos. C66a, C66b and C66c refer).

##### 1.4 Timescale for Completion

The estimated construction time of this Section of Works is 12 months. Since another 6 months are allowed for firearm training programme of the PTS (all site work need to be halted whenever firearms training is carried out), the anticipated construction period of this Section of Works is 18 months.

## **2. THE EXISTING ENVIRONMENT**

### **2.1 Surrounding Land Uses**

The Upper Firing Range at the slope toe is frequently used by the HKPF as well as Customs and Excise Department for the purpose of firearms training. Besides, the range is the only suitable site for long barrel firearms training of the PTS. As advised by the PTS, the normal planned firearms training schedule is approximate XX times a year and each time lasting for about Y weeks. The exact training schedule of PTS will be provided later.

### **2.2 Existing Services**

Drawing No. C66a showing the approximate alignments of existing services has been prepared from information provided by the utility undertakings. Neither the Employer nor his agents accept any responsibility whatsoever for the accuracy of the information and the Contractor shall make such further enquiries and investigation as are required for his own information.

The existing services comprise the public announcement system along the slope toe, soft sub-soil drainage pipes underneath the platform of Upper Firing Range, and salt water mains adjacent to the northern end of slope.

To prevent damage of subsoil drain underneath the platform of the range, no vehicle is allowed to enter the platform. The Contractor shall also avoid stockpiling of heavy plant/material on the platform.

The Contractor shall take adequate measures to protect the public announcement system in the Upper Firing Range. Before commencement of the Works, the Contractor shall temporarily remove the public announcement system along the toe of slope. The Contractor shall be responsible for storing and reinstating of that part of the public announcement system to the satisfaction of PTS and the Engineer.

### **2.3 Existing Traffic Systems and Restrictions**

The sole vehicular access to the Upper Firing Range is Range Road. This road is closed during firearms training of PTS.

### **2.4 Existing Structures**

There is a smoke chamber at the end of Range Road (approximate 30m to the west of the slope). As advised by PTS, the smoke chamber is currently used for storage of ammunitions.

### **2.5 Ground Conditions**

As for ground conditions, please refer to the Stage 3 Study Report No. S3R 266/2002.

All soil nails are designed to be drilled through colluvium and residual soil, and anchored in completely/highly decomposed tuff. If moderately decomposed tuff or better rock is encountered during drilling of soil nail hole, the Contractor shall inform the Engineer immediately and submit the relevant drilling records to the Engineer for review.

The highest recorded groundwater level is approximately 4m below the slope surface. Therefore, high groundwater level is expected during the wet season. The Contractor shall take appropriate precautionary measures against instability of ungrouted holes and difficulty of grouting up the holes.

As specified in Drawing No. C66b, the Contractor shall dig 4 additional inspection pits and carrying out insitu-density tests to investigate the extent and the relative compaction of the fill behind the bullet catcher.

### **3. EXISTING DRAWINGS**

As-built drawings of the Public Works Project "Outdoor Firing Range Improvements, Police Training School, Aberdeen" undertaken by ArchSD in early 90s is available for inspection at the Design Division of Geotechnical Engineering Office, Civil Engineering Department.

### **4. THE DESIGN**

The hazards identified in the design stage are outlined in a Work Impacts Mapping Summary (see Annex 1). Some of the hazards were already dealt with in the detailed design. For instance, in view of sloping terrain, limited working space and close proximity to existing PTS buildings, the final design of the proposed LPM works selected aim at minimizing the construction hazard involved, avoiding use of heavy machinery or construction materials, and reducing the size of the works area required. Further, the works should be easily split up into components that could be carried out in a sequence compatible with the firearms training programme. Noise, dust and construction debris should be kept to an absolute minimum.

Nevertheless, there are some inherent hazards that could not be dealt with at the design stage, some of which has been outlined in a Residual Hazards Summary Sheet (see Annex 2). The Contractor is required to address these issues in the Outline Safety Plan supplemented by detailed Method Statement in due course.

### **5. CONSTRUCTION MATERIALS**

Materials and substances used during construction will also present health and safety hazards. The Principal Contractor will be required to carry out risk assessments on this aspect, and co-ordinate such assessments of other contractors and to introduce appropriate control measures.

### **6. SITE WIDE ELEMENTS**

#### **6.1 Works Site and Works Area**

The Works Site and Works Area provided for the Contractor are shown in the Drawing No. C66a. The exact boundary of the Works Site and Works Area shall be confirmed by the Engineer on site.

## **6.2 Location of Temporary Site Accommodation**

The Principal Contractor is to make proposals for the provision and location of temporary site accommodation for his employees and other contractors for the duration of the works subject to any planning permission requirements.

## **6.3 Location of Unloading, Layout and Storage Areas**

The Principal Contractor is to plan and co-ordinate the provision of unloading, layout and storage areas, to suit the methods of construction and work in progress, subject to the approval of the Engineer or his representatives.

Materials are to be unloaded and stored in locations which will not in any way affect access or egress to the site nor the works. Initial assessment has indicated that the open space, adjacent to Range Road would be used as the storage area for material. The setting up of hoarding will be required to take into accounts of this area.

## **6.4 Site Access and Traffic/Pedestrian Routes**

The traffic/pedestrian routes will require to be managed to ensure the safety of construction workers and the PTS staff is not compromised. All routes are to be agreed with the Engineer or his representatives where necessary before the works commence including any closure, partial restriction or alteration to the agreed routes.

Access to the Works Site shall be from Range Road. No parking or stockpiling is allowed on the road such that it is of driving free without any obstruction at all time during the construction period. The Contractor shall allow enough space for a medium size police vehicle to pass through the Range Road. Suitable warning signs shall also be erected at appropriate locations at the main entrance of PTS and along Range Road to alert the road users of potential danger.

## **6.5 Emergency Routes**

The Principal Contractor will ensure that site operations will not obstruct fire or other emergency services or escape routes.

## **7. OVERLAP WITH CLIENT'S UNDERTAKING**

The Contractor shall make reference to the tentative firearms training schedule of PTS as mentioned in Section 2.1 when preparing their master programme.

## **8. SITE RULES**

### **8.1 General Permit-to-Work Requirements**

On commencement of the works the Principal Contractor will assume total responsibilities for the site.



The rules and requirements as set out in the Contract Documents for Health and Safety shall be followed at all times. The contractor is responsible for consulting statutory authorities as required by the various Acts, Regulations and standards with regards to contamination.

The Principal Contractor will co-ordinate risk assessments related to the works and establish rules and procedures for health and safety issues arising. The site rules should include reference to the following issues:

- (a) Control of persons gaining access to the site
- (b) Briefing of persons gaining access to and working on the site
- (c) Prohibition of Smoking and Alcohol
- (d) Personal hygiene and protective clothing
- (e) Radios and audio equipment
- (f) Emergency procedures
- (g) PPE
- (h) Site induction procedures with specific reference to Fire & other Emergencies, Vehicles on Site, and Use of Harnesses

The arrangements will be controlled and monitored by the Principal Contractor to meet changing needs of the public and site personnel as appropriate to the site operations.

## **8.2 Site Specific Permit-to-Work Requirements**

Special hoarding design is required on this Section of Works. All hoarding within the Upper Firing Range shall be made of two layers and in between a cavity of 75 mm minimum. On the outside facing the range shall be made of 20 mm minimum thick plywood and the inside shall be made of 1mm minimum thick iron plate.

The Contractor shall be responsible for keeping the 'REGAPOLE' rubber ground sheets, the lawn and the underground subsoil drains within the platform of the Upper Firing Range intact on completion of works. Any damages to the ground sheets, the lawn and the drains as a result of the Works shall be repaired at the Contractor's own cost, subject to the satisfaction of the Engineer and the PTS. Before erecting any hoarding, the Contractor shall submit proposed footing details of hoarding on the platform of the Upper Firing Range to avoid damages of the existing rubber ground sheets on the platform of the range for the Engineer's approval.

As mentioned, the Contractor shall cease all site works and evacuate from the Works Site and Works Area during the firearms training, on the grounds of safety and security and shall not re-enter the Works Site and Works Area without the permission of the Engineer. The Contractor shall immediately report to the Engineer if any ammunition or part of ammunition is identified within the Works Site and Works Area.

## 9. CONTINUING LIAISON

### 9.1 Outline Safety Plan and Method Statement

The Work Impacts Mapping Summary (WIMS) which lists some examples of the hazards involved during construction and maintenance is attached in (see Annex 1). It should not be considered as a comprehensive list of every hazard that may be present, but rather a list of typical hazards for the contractor's reference.

The Principal Contractor is required to take appropriate measures to eliminate or reduce and control the hazards created by construction of the LPM works and the environment mentioned above, some of which has been outlined in the WIMS. Based on the Residual Hazards Summary Sheet (see Annex 2), some unresolved hazards during the design stage shall be addressed in the **Outline Safety Plan**. Explanation of the proposed mitigation measures shall also be included in the form of detailed **Method Statement** during construction, which will provide the basis for the management of the risks to health and safety not only of the workers undertaking the work but also of those affected by the work. Any other particular hazards in addition to those above are to be identified by the Principal Contractor, who is to submit proposals as to how their associated risks may be controlled.

The procedures for consideration and evaluation of the health and safety implications of contractor designed elements of the works must follow the recognised principles of prevention and protection and take account of the issues highlighted in the Outline Safety Plan. The Principal Contractor is to provide details of the hazards, and associated risk assessments, to the Engineer or his representatives for approval before execution of the work.

Hazards arising from the use of temporary works are to be identified and risk assessed by the Contractor in advance of the execution of the work.

### 9.2 Procedures for Unforeseen Eventualities During Project Execution

The following action is to be taken in the event of unforeseen eventualities arising during the construction stage of the project which require significant design changes, or affect the resources required to carry out the work without risk to health and/or safety, or have other health or safety implications.

As soon as an unforeseen eventuality arises that affects the design or timescale for the work, the Principal Contractor should notify the Engineer or his representatives.

Full details of the relevant health and safety issues involved are to be reviewed with the Safety Officer and the Contractor as soon as possible.

Full details of any revised designs, risk assessments and identified hazards and/or hazardous materials and substances are to be issued to the Safety Officer and the Contractor in sufficient time to allow for the revision of the Health and Safety Plan and notification of all persons affected by the health and/or safety implications of the changes prior to the commencement of the affected works.

### Annex 1 - Work Impacts Mapping Summary

CEDD Contract No. GE/2003/01 – Upgrading of Retaining Walls, Cut Slopes, and Rock Slopes in Hong Kong Island, Kowloon and New Territories

**Project Title : Landslip Preventive Measures for Slope 15NW-B/C66**

**Location : Upper Firing Range, Police Training School, Aberdeen, Hong Kong**

Activity	Classification Code (See footnote below)	Key Word Development	Description of Impact	Impact Resolved Yes/No	If yes, please state the control measures	Endorsed by Design Reviewer Yes/No
Site Clearance	S	Discovery of ammunition	Workers may identify ammunition and do not know how to handle it	No	A proper reporting procedure in case of ammunition identification will be submitted by the Contractor	✓
	B	Method of removal	Potential damage of public announcement system in the firing range during temporary removal	No	Alignment of the underground cable of the public announcement system will be provided in the Utilities Plan. Contractor will be asked to submit a method statement on temporary removal, storage and reinstatement of the system	✓
	M	Maintenance of 'REGAPOLE' rubber ground sheets	Potential damage of the existing 'REGAPOLE' rubber ground sheets on the platform of the firing range	No	Contractor will be asked to propose protection measures to the rubber ground sheets during the construction period for the Engineer's approval	✓
Works Area	S	Unauthorized entry	Unauthorized entry of the works area - firing range is a sensitive area	No	Security to prevent or deter unauthorised entry into the site will be submitted by the Contractor	✓
	S	Damage of Contractor's properties	Contractor's machinery and tools remain on site may be hit by bullets during firearms training of Police Training School	Yes	Special hoarding specifications will be given for contractor's design	✓
Hoarding & Project Signboard	S	Ricochet	Ricochet - rebound of bullets	Yes	Special hoarding specifications will be given for contractor's design	✓
	B	Hoarding footing	Footing of hoarding damaging the 'REGAPOLE' rubber ground sheets on the platform of the firing range	Yes	Special hoarding specifications will be given for contractor's design	✓
Site Access	S	Traffic management	Impact of construction traffic on the Police Training School	No	Contractor will be requested to provide temporary traffic management measures, temporary signage and lighting	✓

Classification Code : Safety (S) ; Environmental Protection (EP) ; Buildability (B) and Maintainability (M)

## WORKED EXAMPLE NO. 2 - Appendix

Activity	Classification Code (See footnote below)	Key Word Development	Description of Impact	Impact Resolved Yes/No	If yes, please state the control measures	Endorsed by Design Reviewer Yes/No
	S	Manual handling	Potential injury of workers during hand carrying of heavy tools/construction materials from the loading/unloading point (about 30m away from the slope) to the slope	No	Upgrading option requiring lighter plant (e.g. soil nailing) will be adopted. Contractor will be requested to provide safety training to their workers on this issue.	✓
	S	Smoke chamber	Risk of works to smoke chamber and vice versa	No	Risk assessment will be submitted by the Contractor.	✓
	S	Scaffolding	Risk of collapse of scaffolding	No	Contractor should submit a method statement on erection of scaffolding.	✓
	B	Presence of sub-soil drains	Damage of sub-soil drains by construction activities	Yes	Extent of coverage of the sub-soil drains will be provided in the Utilities Plan. Vehicle passage and stockpiling on the platform of firing range will be strictly prohibited under the Contract.	✓
Soil Nailing	S	Pull-out test	Sudden pull-out - potential injury to site personnel	No	Contractor will be requested to provide safety training to its workers on this issue.	✓
	S	Falling objects	Potential fall of objects during installation of soil nails	No	Contractor will be asked to provide safety measures such as 200mm high toe board.	✓
	S	Falling from height	Fall of persons from scaffolding during installation of soil nails	No	Contractor will be asked to provide safety measures such as 400mm wide walkway and 1000mm high guardrail.	✓
	S	Manual handling	Potential injury to site personnel in carrying heavy objects, such as steel bars and installation gear	No	Upgrading option requiring lighter plant and materials (e.g. smaller diameter soil nail steel bar) will be adopted. Contractor will be requested to carry out risk assessment and provide safety training to its workers on this issue.	✓
	S	Fabricating and dismantling	Potential danger in fabricating and dismantling the drilling rigs on slope	No	Contractor will be requested to provide safety training to its workers on this issue.	✓
	S	Health of workers	Potential health hazard of the workers during the installation of soil nails and the construction of nail heads	No	Contractor will be requested to provide safety training to its workers on this issue.	✓
	EP	Noise	Noise nuisance to environment and surroundings	No	Noise limits to sensitive receivers (e.g. administration block of Police Training School) will be specified in the Contract. Contractor will be asked to propose noise mitigation measures to achieve the specified limits.	✓

Classification Code : Safety (S) ; Environmental Protection (EP) ; Buildability (B) and Maintainability (M)

**Landslip Prevention Work to Slope No.15 NW-B/C66  
at Upper Firing Range, Police Training School, Aberdeen**

Activity	Classification Code (See footnote below)	Key Word Development	Description of Impact	Impact Resolved Yes/No	If yes, please state the control measures	Endorsed by Design Reviewer Yes/No
	EP	Dust	Dust nuisance to environment and surroundings	No	Contractor will be asked to provide appropriate mitigation measures, e.g. tarpaulin sheet, water spraying system and wheel washing facility	✓
	EP	General site cleanliness	Potential overflow of surface runoff	No	Contractor will be required to provide temporary drainage measures, e.g. sandbag	✓
	EP	Tree protection	Damage of tree roots by soil nailing	Yes	Exact nail positions are subject to the Engineer's agreement prior to commencement of works	✓
	B	Working space	Limited working space may constraint the progress of works	Yes	Upgrading option requiring smaller working space (e.g. soil nailing) will be adopted	✓
	B	Overflow of grout	Overflow of grout may contaminate the 'REGAPOLE' rubber ground sheets on the platform of the firing range as well as seep into the ground and block the sub-soil drains underneath the platform of the firing range	No	Contractor will be required to provide temporary containment measures by provision of interceptors in the temporary drainage system	✓
	B	Phased construction	Intermittent cessation of soil nail works during firearms training	No	Contractor will submit a programme of work to accommodate the firearms training schedule	✓
	M	Corrosion problem	Potential long term corrosion problem of soil nail steel bar	Yes	Hot dip galvanization of steel bar will be specified in the Particular Specification	✓
	M	Ricochet	Potential ricochet (rebound of bullet) on the soil nail heads	Yes	Recess soil nail head design will be adopted	✓
Raking Drain	EP	Aesthetic	Surface erosion due to discharge of the raking drains	Yes	Erosion control mat will be specified	✓
	M	Blockage of drain	Potential blockage of raking drain after installation	Yes	Appropriate maintenance programme including flushing of raking drains will be developed	✓
Landscaping	S	Falling from height	Fall of persons from slope during planting works	No	Contractor will be requested to provide safety training to its worker on this issue	✓
	EP	Aesthetic	Visual impact of slope works to Ocean Park to the east of the slope (Aerial Ropeway approximately 180m away)	Yes	Appropriate landscaping measures to slope surface will be specified	✓
	M	Establishment period of vegetation (I)	Surface erosion on slope during establishment period of the vegetation	Yes	Erosion control mat will be specified	✓
	M	Establishment period of vegetation (II)	Effect of maintenance works on the firearm training schedule and vice versa	Yes	Appropriate maintenance programme will be developed with the Police Training School	✓

Classification Code : Safety (S) ; Environmental Protection (EP) ; Buildability (B) and Maintainability (M)

### Annex 2 - Residual Hazards Summary Sheet

CEDD Contract No. GE/2003/01 – Upgrading of Retaining Walls, Cut Slopes, and Rock Slopes in Hong Kong Island, Kowloon and New Territories

**Project Title : Landslip Preventive Measures for Slope 15NW-B/C66**

**Location : Upper Firing Range, Police Training School, Aberdeen, Hong Kong**

Hazards/Work Impacts	Design Considerations	Contractor's Attention	Remarks
Discovery of ammunition – workers may discover ammunition and do not know how to handle it	Specify the requirement to report to the Engineer in case of discovery of ammunition	Submit a proper reporting procedure in case of discovery of ammunition	To address in the Outline Safety Plan
Method of removal – potential damage of public announcement system in the firing range during temporary removal	Provide alignment of the underground cable of the public announcement system in the Utilities Plan	Submit a method statement on temporary removal, storage and reinstatement of the system	To address in the method statement
Maintenance of 'REGAPOLE' rubber ground sheets – potential damage of the existing 'REGAPOLE' rubber ground sheets on the platform of the firing range	Require the contractor to provide adequate measures to reduce the risk	Propose protection measures to the rubber ground sheets during the construction period	To address in the method statement
Unauthorized entry of the works area – firing range is a sensitive area	Provide hoarding around the Works Site and Works Area	Submit security system to prevent or deter unauthorized entry into the site	To address in the Outline Safety Plan
Traffic management – impact of construction traffic on the Police Training School	Seek advice from relevant authorities during circulation of project plan	Provide temporary traffic management measures, temporary signage and lighting	To address in the Outline Safety Plan and method statement To seek approval from relevant authorities on the temporary traffic arrangement proposal
Manual handling – potential injury of workers during hand carrying of heavy tools/construction materials from the loading/unloading point to the slope (about 30m away)	Adopt upgrading option requiring lighter plant (e.g. soil nailing)	Provide safety training to their workers on this issue	To address in the Safety and Health Training Plan
Risk of works to smoke chamber and vice versa	Seek advice from the Police Training School on how to avoid the impact	Carry out and submit risk assessment of works adjacent to the smoke chamber	To address in the risk assessment
Risk of collapse of scaffolding	Require the contractor to provide adequate measures to reduce the risk	Submit a method statement on erection of scaffolding	To address in the method statement

Hazards/Work Impacts	Design Considerations	Contractor's Attention	Remarks
<p>General hazards related to soil nailing:</p> <ul style="list-style-type: none"> <li>• Pull-out test - potential injury of site personnel due to sudden pull-out</li> <li>• Potential fall of objects</li> <li>• Falling from height - fall of persons from scaffolding</li> <li>• Manual handling - potential injury to site personnel in carrying heavy objects, such as steel bars and installation</li> <li>• Potential danger in fabricating and dismantling the drilling rigs on slope</li> <li>• Health of workers - potential health hazard of the workers during installation of soil nails and construction of nail heads</li> <li>• Noise and dust nuisance to environment and surroundings</li> <li>• General site cleanliness - potential overflow of surface runoff</li> </ul>	<p>Require the contractor to provide adequate measures to reduce the risks; Adopt upgrading option requiring lighter plant and materials (e.g. smaller diameter soil nail steel bar); Specify noise limits to sensitive receivers (e.g. administration block of Police Training School) in the Contract</p>	<p>Provide safety training to its worker on these issue; Carry out and submit risk assessment on manual handling;</p> <p>Propose noise mitigation measures to achieve the specified limits; Provide appropriate dust suppression measures, e.g. tarpaulin sheet and sprinkler; Provide temporary drainage measures, e.g. sandbag</p>	<p>To address in the Safety and Health Training Plan, the risk assessment, the noise monitoring programme and the temporary drainage proposal</p>
<p>Phased construction - intermittent cessation of soil nail works during firearm training</p>	<p>Negotiate with Police Training School to reschedule the firearms training schedule such that longer continuous period is provided to the Contractor</p>	<p>Submit a programme of work to accommodate the firearms training schedule</p>	<p>To address in the master programme</p>
<p>Planting works on slope - falling from height</p>	<p>Require the contractor to provide adequate measures to reduce the risk</p>	<p>Provide safety training to its worker on this issue</p>	<p>To address in the Outline Safety Plan</p>





CDM

*WORKED EXAMPLE No. 3*

*Rural Drainage Rehabilitation Scheme  
Stage 2, Phase 3 - Mo Fan Heung  
Stream Rehabilitation*

Drainage Services Department

## CONTENTS

---

<b>1. Project Information</b>	<b>73</b>
1.1 Scope of Works	
1.2 Project Location	
1.3 The Design Team	
1.4 Dates etc.	
<b>2. Site Environment and Nature of the Works</b>	<b>74</b>
2.1 Site Environment	
2.2 Nature of the Works	
<b>3. Identification of Special Hazards</b>	<b>77</b>
3.1 Safety	
3.2 Environmental Considerations	
3.3 Example of CDM Leading to Improvement in Design	
<b>4. Documentation</b>	<b>80</b>
4.1 Highlights	
4.2 Pre-tender Health and Safety Plan	
<b>5. Views</b>	<b>80</b>
Appendix I - Pre-tender Health and Safety Plan	81

## 1. Project Information

### 1.1 Scope of Works

The proposed works are to build, for the Mo Fan Heung Stream:

- a) a 400m long, 3m wide rectangular drainage channel;
- b) a vehicular crossing across the channel;
- c) a 100m long, 3.5m wide maintenance road;
- d) a 1.6m wide footpath along one side of the channel; and
- e) associated slope and landscaping works.

so as to increase the hydraulic capacity of the Mo Fan Heung Stream.

### 1.2 Project Location

The project is at Mo Fan Heung (模範鄉). Mo Fan Heung, situated at 3.5 km northeast from the Yuen Long Town Centre, is a low-lying area with no proper storm water drainage system.

Figure 1 illustrates the site location of Mo Fan Heung, and Figure 2 shows the proposed works in detail.

This case worked example covers the detailed design stage of the proposed project works.



Figure 1 - Location of the Site in Mo Fan Heung, Yuen Long

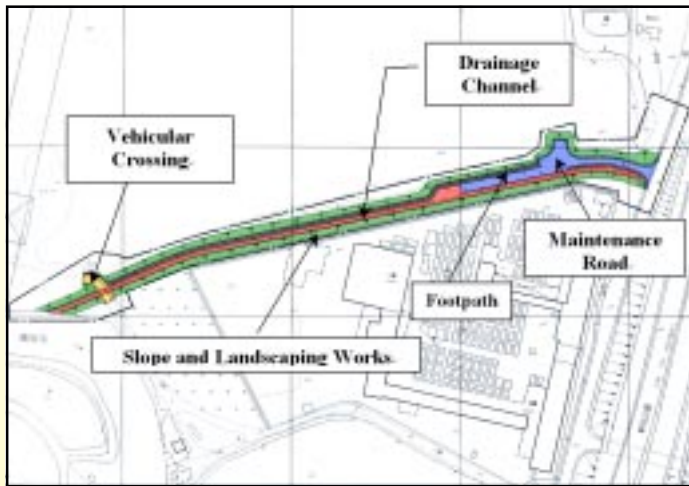
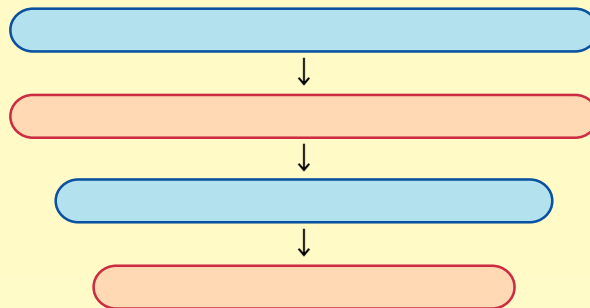

Figure 2 - Details of the Proposed Works

### 1.3 The Design Team

The project's design team comprises of engineers from Drainage Services Department (DSD) of HKSAR Government, as follows:



### 2.1 Site Environment

Figure 3 depicts the features of the site area that will be described in more detail in following sub-sections.



Figure 3 - Existing Features around the Site Area

### Soya Sauce Factory

- Special attention should be paid to potential vibration and settlement of the factory caused by excavation and erection of sheetpiles.
- Dust, noise and wastes produced during construction may affect the operation of the factory.
- Temporary traffic diversion near the entrance point of the factory is anticipated.
- The drainage and sewage system of the factory will be affected during construction.
- Temporary drainage diversion to collect storm water in the Mo Fan Heung area is required and may affect the normal operation of the factory.



Figure 4 - General View of the Soya Sauce Factory



Figure 5 - Meander of the Kam Tin River where the flow of the proposed channel will be discharged to

### Kam Tin Meander

- Construction works at the outlet of the proposed channel may disturb the natural condition of the meander including ecology, riverbed condition and existing grass embankment etc.
- Upon completion of the proposed channel, the additional flow from the channel will increase the flow volume of the meander and also disturb the natural stream flow. Increased turbulence and flow volume are expected at the outlet of the channel.

### Existing Vehicular Crossing

- A new vehicular crossing which is a box culvert to be constructed across the channel will serve to maintain traffic flow at the crossing. The road level will be slightly modified to suit the channel height. Safety fence and other traffic sign will be provided.



Figure 6 - General View of Existing Vehicular Crossing



### Castle Peak Road

- A vehicular run-in for the access of maintenance vehicles to the proposed channel will be constructed near the inlet of the channel along the Castle Peak Road.
- The existing road markings and traffic signs will be modified to suit the special traffic arrangement.
- The embankment along the Castle Peak Road at the inlet of the channel will be removed and backfilled to form the maintenance access road.



Figure 7 - Castle Peak Road (at the proposed site entrance)



Figure 8 - Pylon and Overhead Cable near the Site Area

### Pylon and Overhead Cables

- Maintenance access for the facilities might be affected and therefore access should be maintained during construction. The vehicular crossing should allow maneuver of maintenance equipment.
- The height of construction plant especially the sheetpiling equipment should be restricted and monitored to avoid disturbing the overhead cables.

## 2.2 Nature of the Works

The following project's work processes have been listed for further identification of special hazards:

### Construction of Drainage Channel

- (a) Preparation of the works area and site access;
- (b) Excavation of sediment or soil to form the channel;
- (c) Removal of excavated materials and other obstructions for disposal;
- (d) Stockpiling of excavated materials for on-site use; and
- (e) Channel lining.

### **Construction of Channel Crossing (Box Culvert)**

- (a) Excavation of sediment or soil;
- (b) Removal of excavated materials; and
- (c) Construction of box culvert structure.

### **Construction of Maintenance Road and Footpath**

- (a) Forming embankment;
- (b) Cutting and filling of earth to form the access road; and
- (c) Construction of pavement.

## **3. Identification of Special Hazards**

### **3.1 Safety**

- Sheet piles will be provided on the side adjacent to the existing soya sauce factory during excavation for the construction of the proposed channel. The piling is a source of concern. Vibration to and settlement of the adjacent factory should be considered.
- A temporary working platform in the existing meander of Kam Tin River is required to be erected at the outlet of the proposed channel. Dewatering the working space is required. Particular attention should be paid to the workers working in the river.
- A temporary bridge will be provided to maintain the traffic flow of the existing vehicular crossing at the downstream of the proposed channel during construction. Safety of the public, workers and drivers should be ensured.
- Excavation work is required upstream of the proposed channel adjacent to Castle Peak Road. Temporary stabilization work to the road is expected. Special consideration should be given to the safety of pedestrians and drivers along the Castle Peak Road.
- Works is required to connect the existing 2500mm diameter storm water pipe to the proposed channel. Storm surge may be a threat to the safety of workers during construction. Temporary works to stabilize the existing drainage structure is anticipated.
- There is a risk of flooding during construction that may have an impact on the safety of the workers, the public and all surrounding facilities. A contingency plan will have to be provided to avoid or minimize the damages due to flooding in the works area during construction on the completed permanent works and temporary plant and facilities



- Vehicles and pedestrians may accidentally drop into the channel due to unauthorized or unintended entry to the maintenance access ramp or at the vehicular crossing.
- Safety issues during land surveying, ground investigation, construction and maintenance due to existence of utilities (both above ground and underground) and lamp posts should be considered.
- Temporary storm water diversion during the construction stage is required. It should be sized to ensure no flooding could occur during wet seasons encountered in the construction period. Safety measures should be provided along the temporary drainage channel.
- Maintenance vehicles entering the proposed access from the Castle Peak Road side may affect the safety of the surrounding traffic.
- The general safety of the workers and public during construction.

### 3.2 Environmental Considerations

- Construction noise.
- Dust and smoke resulted from plant operations during construction stage may affect the factory and the public.
- Solid wastes from the site including debris, dredged soil, gasoline, used construction materials and any other construction waste.
- Waste water produced from construction may be discharged to the meander of Kam Tin River at the downstream of the proposed channel or the adjacent wetland. Wheel-washing bay, sand trap and filter tank will be used during construction to minimize the impact on the environment.
- Contaminated mud dredged from the river bed of the Mo Fan Heung Stream should be disposed of properly.
- Upon completion of the works, there will be some visual impact on the natural meander of the Kam Tin River and the grassland at the north of the proposed channel. Future development of the grassland should be considered.
- A number of trees will have to be relocated upon completion of works.
- Since the proposed drainage work is a designated project under EIAO, an Environmental Permit is required from EPD.

### 3.3 Example of CDM Leading to Improvement in Design

The operation of the soya sauce factory is vulnerable to any dust emission from the drainage channel project. In addition to common dust suppression measures such as water spraying and control on site vehicle speed limit, a 3.5m high hoarding will be erected to prevent dust spreading to the factory. See Figures 9 to 11 for the hoarding details.



Figure 9 - Fermentation Tanks in the Soya Sauce Factory

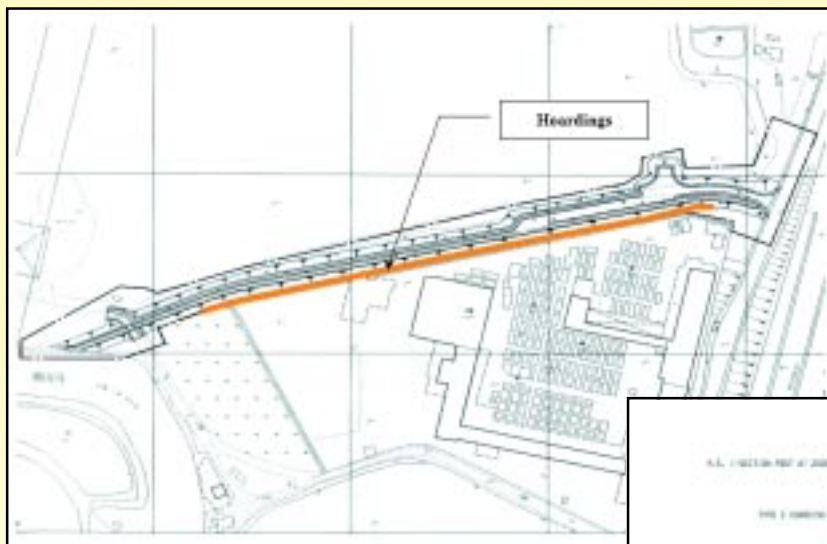

Figure 10 - Hoardings Proposed to Protect the Soya Sauce Factory

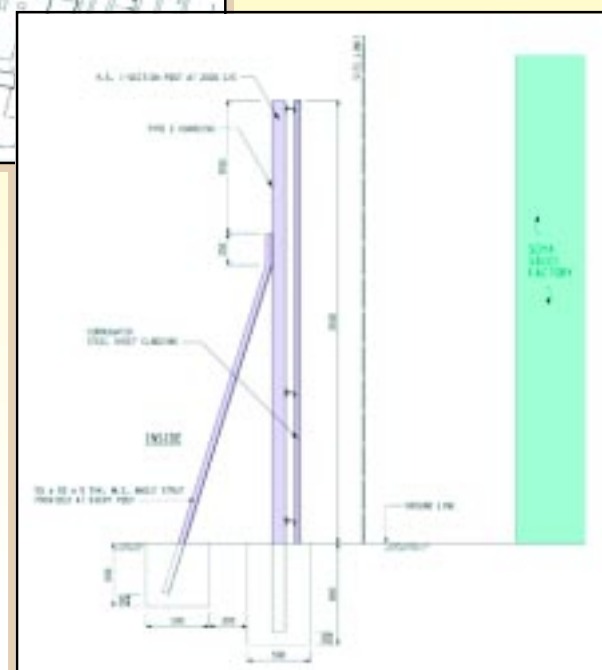

Figure 11 - Sectional View of the Hoardings

## 4. Documentation

The Pre-tender Health and Safety Plan will not form part of the Contract and is provided for information only to assist the Contractor in the preparation of the Outline Safety Plan.

### 4.1 Highlights

Sample items required to be included in the Contractor's Outline Safety Plan as stated in the Pre-tender Health and Safety Plan.

- (i) It is expected sheet piles will be installed as temporary works for excavation during construction of the drainage channel. The Contractor is reminded about the hazard of being trapped by collapsed or overturned objects during the installation process and the potential effect on nearby structures, such as settlement due to the vibration induced during the construction.
- (ii) The hazard of working in existing watercourse is required to be addressed in the outline safety plan.

### 4.2 Pre-tender Health and Safety Plan

The Pre-tender Health and Safety Plan is attached in Appendix I.

## 5. Views

For smooth execution of CDM, communication amongst design team members, client, safety or environmental specialists / advisors and other stakeholders is of paramount importance. It is critical that innovative remedial measures or ideas be proposed for solving the identified issues and ultimately achieving a better design which is practicable and acceptable to all parties involved.

Input from the parties involved should be useful during brainstorming on the project's potential issues or risks. Implementation of the CDM process provides an opportunity to identify any potential hazards at the early stage of the project so that they can be eliminated or mitigated prior to the commencement of the construction stage.

# *APPENDIX I*

## **Pre-tender Health and Safety Plan**

## APPENDIX I - PRE-TENDER HEALTH AND SAFETY PLAN

### Appendix XXX to Conditions of tender Pre-tender Health and Safety Plan

(This Pre-tender Health and Safety Plan will not form part of the Contract and is provided for information only to assist in the preparation of the Outline Safety Plan)

#### 1. GENERAL

##### 1.1 Document

This document merely serves as a guideline to the tenderers, for the preparation of the Outline Safety Plan.

The health and safety considerations outlined herein had been included comprehensively in various parts of the tender document. This document is therefore regarded as a summary of the health and safety items which the tenderers would have considered.

##### 1.2 Commencement of "Construction Phase"

The Contractor should not commence the construction phase until he has adapted and developed his Safety Plan as stated in section 9 of this document. The Contractor should submit the Safety Plan to the Engineer or his representatives and allow sufficient time for their consideration.

##### 1.3 Programme

In preparing the detailed programme, the Contractor should allow for the adoption of safe working procedures and co-ordinate and rationalize activities to avoid hazards due to clashes of activities.

##### 1.4 Sub-Contractors, Suppliers & Designers

The Contractor should ensure that the provision of all his direct appointments including his sub-contractors, suppliers and designers in connection with this project comply with relevant provisions of the Particular Specification for Site Safety in the Contract.

##### 1.5 Liaison

The Contractor should liaise with the Engineer or his representatives in the preparation of the Safety Plan as required by the Particular Specification for Site Safety.

#### 2. PROJECT DESCRIPTION

##### 2.1 Location of the Site

The Mo Fan Heung Stream at Ngau Tam Mei, Yuen Long, New Territories. Site location is shown on the Drawing No. DDN/131CD/2001.

## **2.2 Description of Work**

As stated in the Particular Specification Clause 1.56.

## **2.3 Estimated Duration of Construction Phase**

As stated in the Form of Tender.

## **3. INFORMATION REQUIREMENTS**

The tenderers should provide the following information in the Outline Safety Plan.

### **3.1 General**

- A copy of his corporate Health & Safety Policy Document.
- An Outline Safety Plan to be submitted with the tender.

### **3.2 Management**

- Details of the personnel and systems to be put in place to prepare, manage, implement and monitor the Safety Plan for the project.
- Details of relevant qualifications and experience held by the persons nominated above, including recent health and safety education and training undertaken.
- Procedures for determining the competence of contractors engaged in the project, whether employed by the Contractor directly or by others, to fulfill their duties under the Contract.

### **3.3 Programme**

- The Contractor should develop the Safety Plan within the first week after the commencement date in order to ensure that the setting up of the site for the works will be carried out properly.

## **4. SITE CONDITIONS**

### **4.1 Surrounding Land Uses and Related Constraints**

There is a soy sauce factory at the south of the proposed channel. Particular attention should be paid to potential vibration and settlement due to excavation and installation of sheetpiles during the construction stage. Temporary traffic diversion near the entrance of the factory is expected. The drainage and sewerage system of the factory may be affected during construction and the Contractor is required to implement temporary water diversion to deal with this. In addition, dust, noise and wastes generated during construction may affect the operation of the factory.

As the works are to be carried out at and in the vicinity of the existing Mo Fan Heung Stream, temporary water diversion is required. The proposed channel will connect to an existing meander of Kam Tin River at the downstream. Temporary cofferdam and water pumping will be adopted. Construction works at the outlet of the proposed channel may disturb the natural condition of the meander such as riverbed condition and existing vegetation on the embankment. Upon completion of the proposed channel, additional flow from the channel will increase the flow in the meander. Hence, additional turbulent and increased flow is expected at the outlet of the channel.

### **4.2 Existing Traffic Conditions and Constraints**

The proposed site will be accessible through Castle Peak Road. The existing road will be modified to suit the proposed traffic arrangement. The embankment along the Castle Peak Road will be modified to form the maintenance access road. Temporary traffic diversion to be implemented may affect the entrance of the factory, a nearby cargo storage area and a bus-stop.

### **4.3 Existing Services**

A pylon is located near the downstream of the existing stream and there are overhead cables alongside of the proposed channel. Maintenance access to this pylon should be maintained during construction. The vehicular crossing should allow manoeuvre of maintenance plant. The height of construction plant especially for sheetpiling plant should be monitored to avoid interfacing with the overhead cables.

Works will also be carried out near an existing 2500mm diameter storm water pipe. Substantial amount of storm water suddenly discharged from this pipe may harm the safety of workers during construction. Temporary works to stabilize the existing drainage structure and structure under construction is also necessary.

There are telephone cable ducts underneath the footpath of the Castle Peak Road and the existing truck road. They have to be detected, identified and avoided/diverted where possible.

### **4.4 Existing Structure**

At the downstream of the proposed channel, there is an existing track road crossing the channel. A vehicular crossing will be provided to maintain the traffic at the track road. The road level will be slightly modified to suit the channel height. Fencing and other safety facilities should be provided.

### **4.5 Fire Precautions and Means of Escape**

The Contractor should prepare a detailed Fire Plan to highlight proposed fire precautions, means of escape and sequence of works at the Site Office or on the Site as necessary. The Contractor should also update and amend this plan as necessary.

#### **4.6 Existing Ground Conditions**

The results of the ground investigation revealed that the underground materials included fill material, marine deposit, alluvium and completely decomposed tuff at various depths. As contaminated mud was encountered at the bed of the Mo Fan Heung Stream, the Contractor is required to handle and dispose of this contaminated mud with great care and in accordance with the requirements specified in the Contract.

#### **4.7 Adjacent Projects**

The Contractor and other contractors involved in the works should liaise and co-ordinate with any other parties carrying out works in the vicinity and with any others likely to be affected by the works on site. These may include local residents, businesses and other construction projects.

The Contractor should develop a suitable system to enable those whom may be affected by relevant works to be informed in good time before the works start, so that they can make appropriate arrangement if necessary.

### **5. EXISTING DRAWINGS AND INFORMATION**

#### **5.1 Existing Drawings**

A selection of existing drawings of the site is available for inspection at the Drainage Services Department.

#### **5.2 Information Available for Inspection**

The Drainage Services Department will keep and make information regarding the works at Mo Fan Heung Stream available for inspection at the office. The information provided is for reference purpose only.

### **6. THE DESIGN**

#### **6.1 Principal Hazards Identified by the Project Team**

Significant hazards or necessary work sequences which may be a risk to workers' health and safety as well as information that the Contractor may not be reasonably expected to know are summarized in the Hazards Summary in the Annex. This summary does not include commonplace site hazards which are deemed to be familiar to the average competent contractors and can be controlled by normal good site management practices.



## **6.2 Contractor's Proposals**

The Contractor should take appropriate measures to eliminate or reduce the risks of the hazards detailed in the Hazards Summary and throughout this document. Explanation of the proposed measures is to be included in the form of detailed method statements. Any other particular hazards in addition to those described in this document are to be identified by the Contractor, who is to submit a proposal to illustrate how their associated risks will be controlled.

## **7. SITE WIDE ELEMENTS**

### **7.1 Site Access and Egress**

Site vehicles are expected to enter the site through the only entrance to be formed by the Contractor near the upstream of the proposed channel at Castle Peak Road. The Contractor is required to remove rubbish and demolition materials regularly and maintain free access through the designated means of escape at all times.

The Contractor is required to prepare proposals for the delivery of materials into or out of the Site and for the temporary traffic arrangement.

### **7.2 Location of Temporary Site Accommodation**

The Contractor is required to prepare proposals for the temporary site accommodation for Drainage Services Department's site staff, his employees and other contractors during the execution of the Works in accordance with the Particular Specification.

Temporary site accommodation is to be located in a position such that access to the Works and the neighbouring properties will not be interfered. Formal confirmation from the Engineer or his representatives is required prior to the commencement of the works.

### **7.3 Location of Unloading, Layout and Storage Areas**

The Contractor is required to plan and co-ordinate unloading, layout and storage area to suit the methods of construction and sequence of works. Materials should be unloaded and stored in locations such that access to the works will not be affected and the neighbouring properties will not be interfered. The location is subject to the approval of the Engineer or his representatives.

### **7.4 Traffic and Pedestrian Routes**

The Contractor should ensure the safety of the road users. The temporary crossing and other associated measures should be provided to maintain the flow of the existing track road crossing the proposed channel at the downstream during construction.

In addition, all signage and barriers necessary for safety and diversion purposes should be put in place to protect pedestrians and drivers at the site entrance in Castle Peak Road.

## 7.5 Environment

Dust emission and gas resulted from operation of plant during construction stage may affect the operation of the factory and the surrounding environment. Solid wastes produced during construction such as debris, dredged soil, used construction materials and any other construction wastes are expected. Wastewater produced during construction may be discharged to the meander of Kam Tin River at the downstream of the proposed channel or the adjacent area. Wheel-washing bay, sand trap and filter tank should be used during construction to minimize impact to the environment. The Contractor should take precautions to protect against pollution of watercourses and the air. Wastes should be disposed of in accordance with the requirements stipulated in the Contract. In addition, construction nuisance is expected during the construction of the proposed works. The Contractor is required to provide protective measures against noise. Machinery should not be kept running unnecessarily.

## 8. SITE RULES

### 8.1 Permit to Work Requirements

Upon commencement of the Works, the Contractor should assume total responsibility for the site.

The Contractor is responsible for consulting statutory authorities as required by various regulations and standards related to contamination. The Contractor should co-ordinate risk assessment in respect of the works and establish rules and procedures for health and safety issues. The site rules should include reference to the following issues:

- Institute a "hot work" permit system in respect of metalwork flame cutting, site welding, asphalt repairs and the like.
- Working in confined spaces
- Working in excavated trench / cofferdam
- Control of persons gaining access to the site
- Briefing of persons gaining access to and working on the site
- Prohibition of smoking and alcohol
- Personal hygiene and protective clothing
- Radio and audio equipment
- Emergency procedures
- Personal protective equipment
- Site induction procedures with specific reference to fire & emergencies, vehicles on site and use of harnesses

The arrangements should be controlled and monitored by the Contractor to meet changing needs of site personnel and site operations.

## **8.2 Injury**

The Contractor is responsible for maintaining proper first aid facilities administered by qualified personnel. The Contractor should make arrangements to notify all accidents to the Works Branch.

## **9. CONTINUING LIAISON**

### **9.1 Health and Safety Implications of Contractors' Designs**

The procedures of considering and evaluating health and safety implications of design elements of the contractors must follow the recognized principles of prevention and protection and take account of the issues highlighted in this Pre-tender Stage Health and Safety Plan. The Contractor is required to provide details of the hazards and associated risk assessments before execution of the works.

The Contractor should identify hazards arising from the use of temporary works and assess the risk in advance of the execution of the works.

The Contractor should provide suitable and sufficient information to demonstrate that health and safety issues have been adequately and fully considered.

The Contractor should prepare risk assessments, a list of health and safety hazards identified, and a list of any materials or substances which are specified or inherent in the design and are potentially hazardous to health and/or safety.

### **9.2 Unforeseen Eventualities**

Unforeseen eventualities may arise during project execution resulting in substantial design change and which might affect resources. If any re-design is found to be necessary, the Engineer or his representatives and, the Contractor are to be advised as soon as possible. Full details of the revised design should be issued. Details of hazards and risk assessment should be prepared and incorporated into the Health and Safety Plan for the Engineer's or his representatives' consideration before execution of the works. All personnel affected by the health and/or safety implications of the changes should be notified prior to the commencement of the affected works.

### **9.3 Safety Plan**

The Contractor should modify the Safety Plan to reflect variations in design or changes in site conditions and liaise with the Safety Officer.

The Contractor should develop a pre-tender Health and Safety Plan which will:

- Incorporate the Contractor's approach to construction management to ensure that the health and safety of all personnel carrying out the construction works and all personnel whom may be affected by their works;

- Include risk assessments;
- Include method statements and appropriate and sufficient measures to be adopted by the Contractor for construction works to ensure the health and safety of all persons whom may be affected by these works;
- Include common arrangements for statutory notices and register, etc;
- Include reasonable arrangements for compliance with health and safety legislation and site rules;
- Include reasonable measures to ensure co-operation among the Contractor and sub-contractors in respect of health and safety provisions and prohibitions;
- Include the steps to be taken to ensure that only authorized persons are allowed to enter the site where construction works are being carried out;
- Include emergency procedures and the arrangement for display of notice related to these procedures;
- Include arrangements to ensure that all personnel of the Contractor and sub-contractors working on the site and visitors to the site are provided with adequate training as well as comprehensive information about the risks arising from the construction works and emergency procedures;
- Include arrangements to ensure that all personnel of the Contractor and sub-contractors carry out their work in a healthy and safe manner on the site;
- Include arrangements for the reporting of any accidents, injuries or dangerous occurrences; and
- Be modified as the works proceed by taking account of any information received from the Contractor / sub-contractors, any experience gained in the course of the project or any necessary alterations as a result of unforeseen circumstances.

#### **9.4 Site Liaison**

The Contractor should liaise with all other contractors and amend the Safety Plan after the liaison if necessary. The Contractor should set up regular training for all operatives including induction training for all staff upon arrival to the site.

#### **9.5 Health and Safety File**

The Contractor should provide any relevant information which he believes should be incorporated into the Health and Safety File.

#### **9.6 Design Development**

The Contractor should arrange liaison meetings with sub-contractors to discuss and review health and safety issues arising from the sub-contractors' designs.

**Annex : HAZARDS SUMMARY**

**PWP Item No. 4131CD**

**Drainage Improvement Works at Mo Fan Heung Stream**

**Hazards Summary**

**I) Construction of Drainage Channel**

ACTIVITIES	HAZARD	DESIGN CONSIDERATIONS	CONTRACTOR'S ATTENTION	NOTES
<ul style="list-style-type: none"> <li>Preparation of works area and site access</li> <li>Erection of Site Hoarding</li> </ul>	<ul style="list-style-type: none"> <li>Trapped by collapsing or overturning object</li> <li>Fall of person from height</li> </ul>	<ul style="list-style-type: none"> <li>Specify hoarded area for access and erection of protection works</li> <li>Specify the requirements of competent site supervision</li> <li>Liaise with villagers and the owner of the factory on the construction works</li> <li>Consider public expectation in the design</li> </ul>	<ul style="list-style-type: none"> <li>Complete the erection of site hoarding before site clearance works</li> <li>Maintain close communication with villagers and the owner of the soya sauce factory</li> <li>Maintain proper assess with adequate safety measures such as barriers</li> </ul>	<ul style="list-style-type: none"> <li>To address in the Safety Plan</li> </ul>
<ul style="list-style-type: none"> <li>Installation of Sheet Piles</li> </ul>	<ul style="list-style-type: none"> <li>Trapped by collapsing or overturning object</li> <li>Vibration and settlement</li> </ul>	<ul style="list-style-type: none"> <li>Specify the requirements of competent site supervision</li> </ul>	<ul style="list-style-type: none"> <li>Provide adequate temporary support system</li> <li>Submit design and method statement of temporary works, which shall be checked by an independent checking engineer before installation</li> <li>The system shall be certified by a Competent Person before workers can carry out excavation works</li> <li>Provide competent and close site supervisions</li> <li>Maintain proper access</li> </ul>	<ul style="list-style-type: none"> <li>To address in the Safety Plan</li> </ul>
<ul style="list-style-type: none"> <li>Excavation near Utilities</li> </ul>	<ul style="list-style-type: none"> <li>Damage to Utilities</li> <li>Contact with electricity or electric discharge</li> </ul>	<ul style="list-style-type: none"> <li>Obtain information about the existing and planned utility works from relevant utility undertakers</li> <li>Revise design to minimize the potential interface with utilities</li> </ul>	<ul style="list-style-type: none"> <li>Excavate trial pits for excavation near underground utilities</li> <li>Pay special attention when excavator operates near overhead cable</li> </ul>	<ul style="list-style-type: none"> <li>To address in the Safety Plan</li> </ul>
<ul style="list-style-type: none"> <li>Excavation</li> </ul>	<ul style="list-style-type: none"> <li>Noise Pollution to Sensitive Receivers and workers</li> <li>Dust Emission</li> <li>Pollution to existing watercourse</li> <li>Drowning</li> </ul>	<ul style="list-style-type: none"> <li>Reduce the depth of excavation by keeping the invert level of the proposed drainage channel higher</li> <li>Apply for an environmental permit</li> </ul>	<ul style="list-style-type: none"> <li>Carry less excavation in December and January when wind blows towards the soya sauce factory</li> <li>Stagger the works into sections to reduce dust emission.</li> <li>Provide remedial measures such as mist curtain, wheel wash basin, regular water spraying, paved road, slow car speed, fence, screen and spraying of grass.</li> </ul>	<ul style="list-style-type: none"> <li>To address in the Safety Plan</li> <li>To reflect work sequences in the master programme</li> </ul>

I) Construction of Drainage Channel

ACTIVITIES	HAZARD	DESIGN CONSIDERATIONS	CONTRACTOR'S ATTENTION	NOTES
<ul style="list-style-type: none"> <li>Stockpiling of excavated material for on-site use</li> </ul>	<ul style="list-style-type: none"> <li>Dust Emission</li> <li>Trapped by collapsing or overturning object</li> </ul>	<ul style="list-style-type: none"> <li>Specify the requirements of competent site supervision.</li> </ul>	<ul style="list-style-type: none"> <li>Cover excavated material before backfilling.</li> <li>Spray water occasionally</li> <li>Excavation will only be allowed if subsequent backfilling work is foreseeable.</li> <li>Backfilling work is suggested to be carried out as soon as possible.</li> </ul>	<ul style="list-style-type: none"> <li>To address in the Safety Plan.</li> <li>To reflect work sequences in the master programme.</li> </ul>
<ul style="list-style-type: none"> <li>Disposal of contaminated sediment</li> </ul>	<ul style="list-style-type: none"> <li>Pollution to existing watercourse</li> <li>Exposure to or contact with harmful substance</li> </ul>	<ul style="list-style-type: none"> <li>Liaise with EPD on the proposed disposal scheme</li> <li>Adopt uniform drainage channel section to minimize the production of solid wastes.</li> <li>Reduce the depth of excavation by keeping the invert level of the proposed drainage channel higher</li> <li>Retain most of the existing structures to reduce the amount of demolition waste.</li> </ul>	<ul style="list-style-type: none"> <li>Carry out chemical and biological testing on mud samples obtained from the site before construction to determine the level of contamination of the excavated mud.</li> <li>Use these results to identify the possible disposal site, probably East Sha Chau for those contaminated muds.</li> <li>Carry out special treatment if the level of contamination is severe as suggested by EPD.</li> <li>Dispose the contaminated sediment found during excavation to designated site.</li> </ul>	<ul style="list-style-type: none"> <li>To address in the Safety Plan.</li> </ul>
<ul style="list-style-type: none"> <li>Disposal of solid waste produced</li> </ul>	<ul style="list-style-type: none"> <li>Pollution to existing watercourse</li> </ul>	<ul style="list-style-type: none"> <li>Liaise with relevant department concerning the landfill site.</li> </ul>	<ul style="list-style-type: none"> <li>Screen solid wastes before disposal to the designated landfill site and local dumping shall be prohibited.</li> <li>Adopt trip ticket system for the disposal of construction and demolition waste.</li> </ul>	<ul style="list-style-type: none"> <li>To address in the Safety Plan.</li> </ul>
<ul style="list-style-type: none"> <li>Transportation of excavated material off the site</li> </ul>	<ul style="list-style-type: none"> <li>Dust emission</li> </ul>	<ul style="list-style-type: none"> <li>Specify the requirements to minimize the dust nuisance.</li> </ul>	<ul style="list-style-type: none"> <li>Provide wheel washing bay for trucks</li> <li>Cover the excavated material during transportation off the site.</li> </ul>	<ul style="list-style-type: none"> <li>To address in the Safety Plan.</li> </ul>
<ul style="list-style-type: none"> <li>Temporary Stream Water Diversion</li> </ul>	<ul style="list-style-type: none"> <li>Drowning</li> </ul>	<ul style="list-style-type: none"> <li>Advance flow diversion to facilitate good site drain management.</li> <li>Identify services that may be affected by the diversion work.</li> </ul>	<ul style="list-style-type: none"> <li>The design and method statement of the diversion scheme shall be checked by an independent checking engineer.</li> <li>Provide adequate and appropriate safety equipment during the diversion.</li> <li>Set up emergency team to handle flooding incidents.</li> </ul>	<ul style="list-style-type: none"> <li>To address in the Safety Plan.</li> <li>To reflect work sequences in the master programme.</li> </ul>

## WORKED EXAMPLE NO. 3 - Appendix

### I) Construction of Drainage Channel

ACTIVITIES	HAZARD	DESIGN CONSIDERATIONS	CONTRACTOR'S ATTENTION	NOTES
<ul style="list-style-type: none"> <li>Channel Lining</li> </ul>	<ul style="list-style-type: none"> <li>Drowning</li> <li>Fall of person from height</li> <li>Struck by falling objects</li> <li>Environmental Nuisances</li> </ul>	<ul style="list-style-type: none"> <li>Consider this hazard in the design of temporary stream diversion</li> <li>Specify the requirements of competent site supervision.</li> </ul>	<ul style="list-style-type: none"> <li>Erect a temporary working platform in the existing meander of Kam Tin River at the outlet of the proposed channel.</li> <li>Provide safety equipment at the working spaces of workers.</li> <li>Set up emergency team to handle flooding incidents.</li> <li>Provide a safety officer who shall be responsible for the monitoring of safety issues.</li> <li>Adopt appropriate construction method and procedures.</li> <li>Use less chemical for the construction of channel lining.</li> </ul>	<ul style="list-style-type: none"> <li>To address in the Safety Plan.</li> <li>To reflect work sequences in the master programme.</li> </ul>

**II) Construction of Channel Crossing (Box Culvert)**

ACTIVITIES	HAZARD	DESIGN CONSIDERATIONS	CONTRACTOR'S ATTENTION	NOTES
<ul style="list-style-type: none"> <li>Excavation of sediment or soil &amp; Demolition of Existing Stream Crossing</li> </ul>	<ul style="list-style-type: none"> <li>Drowning</li> <li>Struck by falling objects</li> <li>Trapped by collapsing or overturning object</li> <li>Dust Emission</li> <li>Environmental Nuisances</li> <li>Vibration and Ground settlement</li> </ul>	<ul style="list-style-type: none"> <li>Specify the requirements of competent site supervision</li> </ul>	<ul style="list-style-type: none"> <li>Implement temporary stream water diversion which shall be checked by an independent checking engineer</li> <li>Provide safety equipment during the diversion</li> <li>Set up emergency team to handle flooding incidents</li> <li>Provide temporary crossing</li> <li>Erect temporary fence along the crossing</li> <li>Provide temporary support to the crossing during demolition.</li> <li>Provide competent site supervisions for demolition works</li> <li>Introduce remedial measures such as mist curtain &amp; wheel wash bay</li> <li>Monitor the vibration and ground settlement due to excavation and installation of sheetpile during construction</li> </ul>	<ul style="list-style-type: none"> <li>To address in the Safety Plan and Demolition plan</li> <li>To reflect work sequences in the master programme.</li> </ul>
<ul style="list-style-type: none"> <li>Disposal of contaminated mud,</li> <li>Disposal of solid waste produced &amp; Transportation of excavated material off the site</li> </ul>	<ul style="list-style-type: none"> <li>Pollution to existing watercourse</li> <li>Exposure to or contact with harmful substance</li> <li>Pollution to existing watercourse</li> <li>Dust emission</li> </ul>	<ul style="list-style-type: none"> <li>Liaise with EPD on the proposed disposal scheme</li> <li>Adopt uniform drainage channel section to minimize the production of solid wastes.</li> <li>Reduce the depth of excavation by keeping the invert level of the proposed drainage channel higher</li> <li>Retain most of the existing structures to reduce the amount of demolition waste.</li> <li>Liaise with relevant department concerning the landfill site.</li> <li>Specify the requirements to minimize the dust nuisance.</li> </ul>	<ul style="list-style-type: none"> <li>Carry out chemical and biological testing on mud samples obtained from the site before construction to determine the level of contamination of the excavated mud</li> <li>Use these results to identify the possible disposal site, probably East Sha Chau for those contaminated muds</li> <li>Carry out special treatment if the level of contamination is severe as suggested by EPD</li> <li>Dispose the contaminated sediment found during excavation to designated site</li> <li>Screen solid wastes before disposal to the designated landfill site and local dumping shall be prohibited</li> <li>Adopt trip ticket system for the disposal of construction and demolition waste</li> <li>Provide wheel washing bay for trucks</li> <li>Cover the excavated material during transportation off the site.</li> </ul>	<ul style="list-style-type: none"> <li>To address in the Safety Plan</li> <li>To reflect work sequences in the master programme.</li> </ul>
<ul style="list-style-type: none"> <li>Construction of box culvert structure</li> <li>Erection of temporary working platform</li> </ul>	<ul style="list-style-type: none"> <li>Fall of person from height</li> </ul>	<ul style="list-style-type: none"> <li>Specify the requirements of competent site supervision</li> </ul>	<ul style="list-style-type: none"> <li>Ensure workers wear safety belts when working at height</li> </ul>	<ul style="list-style-type: none"> <li>To address in the Safety Plan</li> </ul>



### WORKED EXAMPLE NO. 3 - Appendix

#### III) Construction of Maintenance Road & Footpath

ACTIVITIES	HAZARD	DESIGN CONSIDERATIONS	CONTRACTOR'S ATTENTION	NOTES
<ul style="list-style-type: none"> <li>Forming of embankment</li> </ul>	<ul style="list-style-type: none"> <li>Impact to Water Quality</li> <li>Settlement of embankment</li> </ul>	<ul style="list-style-type: none"> <li>Design the embankment with minimal short- and long- term settlement</li> </ul>	<ul style="list-style-type: none"> <li>Treat construction wastewater before discharging to the existing drainage system</li> <li>Use geotechnical instrument such as inclinometer and extensometer to monitor the stability and settlement of the embankment</li> </ul>	<ul style="list-style-type: none"> <li>To address in the Safety Plan</li> </ul>
<ul style="list-style-type: none"> <li>Cutting and filling of earth to form the access road</li> </ul>	<ul style="list-style-type: none"> <li>Dust emission</li> <li>Struck by falling object</li> <li>Fall of person from height</li> <li>Striking against or struck by moving object</li> </ul>	<ul style="list-style-type: none"> <li>Specify the requirements of competent site supervision</li> </ul>	<ul style="list-style-type: none"> <li>Erect temporary support system with working platform checked by an independent checking engineer</li> <li>Use geotechnical instrument such as inclinometer and extensometer to monitor the effect on the existing carriageway</li> <li>Implement temporary traffic arrangement to divert the traffic flow in Castle Peak Road</li> <li>Fence off the works from the carriageway</li> <li>Keep the fenced area the minimum to avoid obstruction with the existing traffic flow</li> </ul>	<ul style="list-style-type: none"> <li>To address in the Safety Plan</li> </ul>
<ul style="list-style-type: none"> <li>Construction of road pavement</li> </ul>	<ul style="list-style-type: none"> <li>Accidents caused by vehicles and pedestrian</li> <li>Injured whilst lifting or carrying</li> </ul>	<ul style="list-style-type: none"> <li>Specify the location of the entrance of the maintenance access and include it in the design</li> <li>Minimize the interface with the public road</li> <li>Incorporate a vehicular gate with lock in the design enclosing the maintenance access and footpath to prevent unauthorized entry</li> </ul>	<ul style="list-style-type: none"> <li>Erect adequate temporary traffic sign for the road diversion to warn the road users</li> <li>Introduce remedial measures such as fence, barrier and screen</li> <li>Carry out the construction of road pavement in non-peak hours</li> </ul>	<ul style="list-style-type: none"> <li>To address in the Safety Plan</li> </ul>

# CDM

## *WORKED EXAMPLE No. 4*

*Widening of Tolo Highway and  
Fanling Highway - Traffic Control and  
Surveillance System*

Electrical and Mechanical Services Department

## CONTENTS

---

<b>1. Project Information</b>	<b>97</b>
1.1 Scope of Works	
1.2 Project Location	
1.3 The Design Team	
1.4 Programme	
<b>2. Site Environment and Nature of the Works</b>	<b>99</b>
2.1 Site Environment	
2.2 Liaison Activities	
<b>3. Identification of Special Hazards</b>	<b>100</b>
3.1 Improvement in Design under CDM	
3.2 Impacts Summary	
<b>4. Documentation</b>	<b>101</b>
4.1 Highlights	
4.2 Pre-tender Health and Safety Plan	
<b>5. Views</b>	<b>101</b>
Appendix I - Pre-tender Health and Safety Plan	102

## 1. Project Information

### 1.1 Scope of Works

This project comprises the construction of Traffic Control and Surveillance Systems (TCSS) along the widened Tolo Highway and Fanling Highway between Ma Liu Shui Interchange and Wo Hop Shek Interchange. The works includes CCTV traffic surveillance cameras, vehicle incident detection stations, variable message signs lane use signals, fibre optic communication network and a central control and monitoring system. Figures 1 to 3 illustrate some of the TCSS field equipment (taken from other projects).

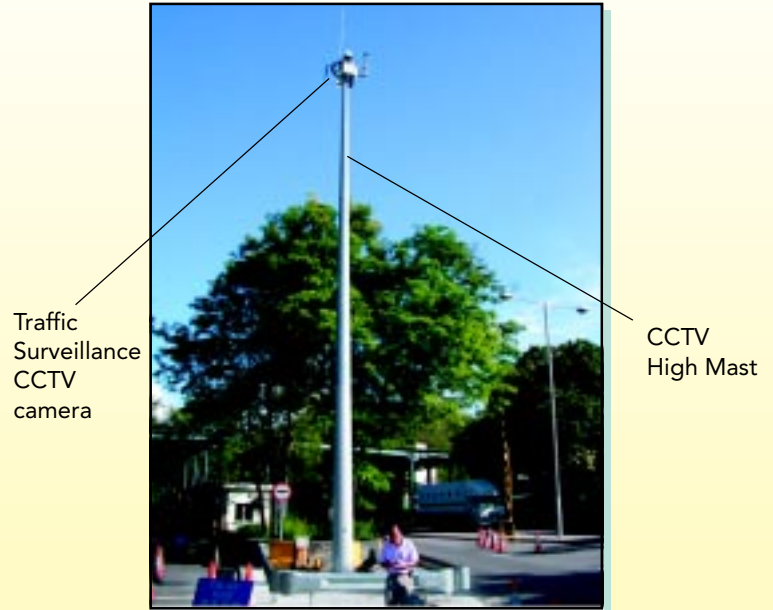

Figure 1 - TCSS : CCTV

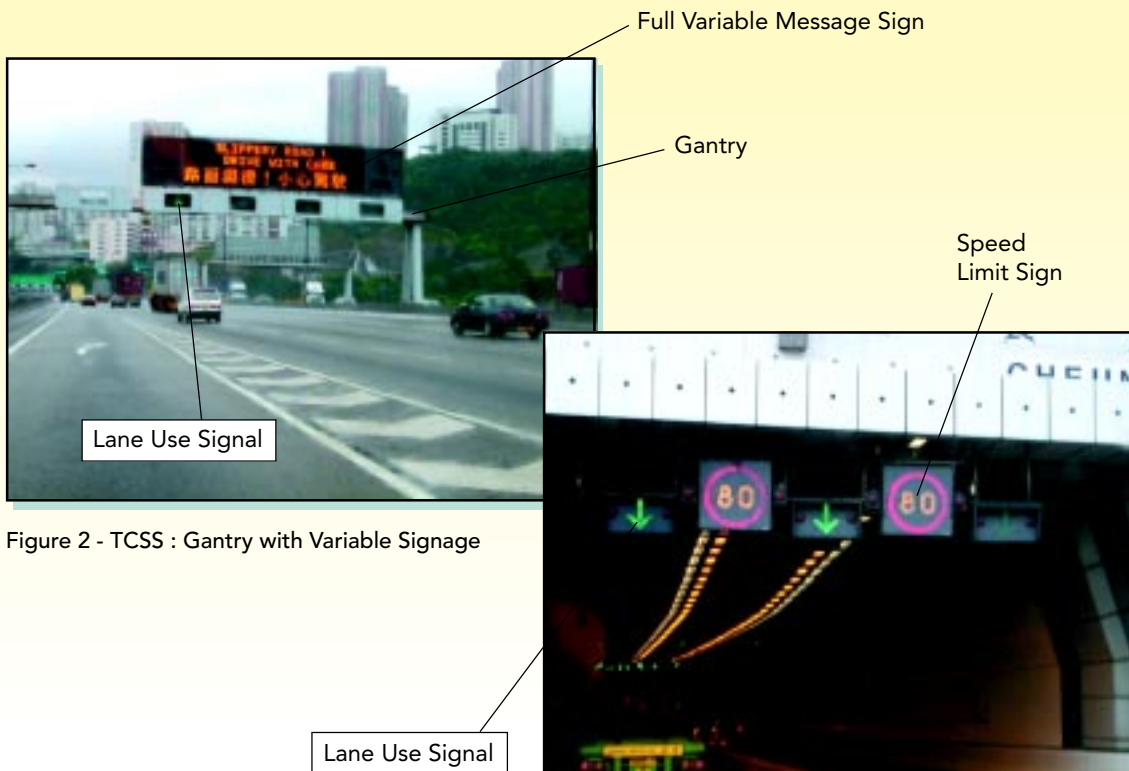

Figure 2 - TCSS : Gantry with Variable Signage

Figure 3 - TCSS : Signage

## 1.2 Project Location

The project is in 2 stages, one associated with the South Section (Stage 1) and the other the North Section (Stage 2). The South Section is from Ma Liu Shui Interchange to Island House Interchange near Tai Po. The North Section is from Island House Interchange near Tai Po to Wo Hop Shek Interchange near Fanling. Figure 4 shows the geographical lay out of the two sections.

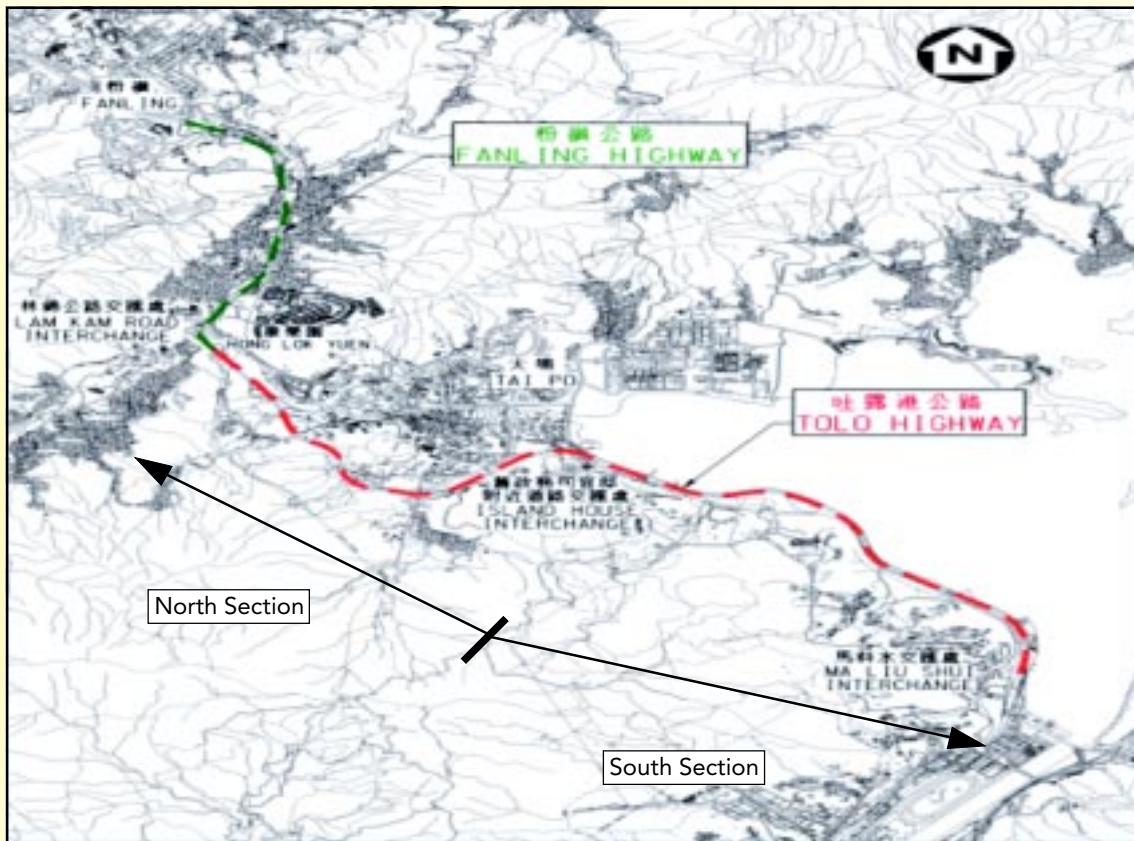

Figure 4 - Layout of Tolo Highway

## 1.3 The Design Team

The design team consists of representatives from three government departments, namely Electrical and Mechanical Services Department, Transport Department and Highways Departments, and a consultant firm from the private sector.

## 1.4 Programme

The contract of the TCSS, is supposed to match with the progress of the civil engineering work on site.

When the contract for this project commences, civil engineering work for the South Section will be completed, and for the North Section, it will still be in progress.

The contract for the TCSS system requires design work for the entire North and South Sections be completed within 14 months of contract award. Subsequently, manufacturing for the South Section will take 6 months, followed by installation, testing and commissioning in another 6 months.

For the North Section, manufacturing of the TCSS system will commence one year after testing and commissioning of the TCSS Systems for the South Section, so as to match the progress of civil engineering work, and will be completed within 3 months and then followed by installation, testing and commissioning of the system which is expected to take another 3 months.

The design of the TCSS is supposed to start around mid 2002.

## **2. Site Environment and Nature of the Works**

### **2.1 Site Environment**

The South Section is a dual 3-lane highway with a 3.3m wide hard shoulder in each direction. During the whole period of implementation, this section will be fully open to traffic in both directions. Road closures or lane closures during daytime for construction work be likely to draw objections and complaints from the travelling public, and must be avoided. There is more freedom for lane closure at night (between 01:00 to 05:00) but that will necessitate traffic diversion to Tai Po Road, with full consultation and prior agreement from the relevant District Councils, Traffic Police, Highways Department and Transport Department. A full Traffic Impact Analysis Report will be needed and any alternative traffic arrangement is subject to consultation.

In the case of full variable message signs, the framework of the sign needs to be erected by the TCSS Contractor on a gantry provided by the main civil contractor. Subsequent to the erection, the wiring will be done and connected to the communication cable network. This is then followed by testing and commissioning, when the electrical and optical characteristics of the field equipment are adjusted. The erection of full variable message signs on the gantries involves the lifting of a 5 ton steel structure from ground level to the top of the gantry (approximately 5.5m from the finished road level), which may have safety implications to the travelling public and necessitates road closure.

Maintenance of the full variable message sign involves maintenance personnel working on the top of the gantry with or without moving traffic below. Closure of one or more of the traffic lanes below may reduce the consequence of falling object from operation but will cause inconvenience to the travelling public. This is main subject in the pre-tender Health and Safety Plan in this worked example.

The North Section was originally designed as a dual 2-lane standard highway. It will be upgraded under a civil engineering contract to a dual 3-lane standard highway, which include the realignment of various slip roads. A 3.3m wide hard shoulder will also be provided where site conditions permit. The work will be held concurrently with the execution of the TCSS Contract. Erection of Full Variable Message Sign on gantries can be done at the same night under the same site possession when the main civil contractor erects the gantry. This is subject to close co-ordination with the civil contractor. The maintenance of any full variable message signs erect on the road will face the same hazards identified for the South Section.

### 2.2 Liaison Activities

During the CDM process, the design team members should have project meetings and liaise with other stakeholders. For example, the consultant is to deal with the traffic police and Highways Department on road closure traffic arrangements. Meetings are necessary with the maintenance section of the Highways Department to consider the maintainability of various TCSS field equipment options e.g. vehicle detection systems. Members of the design team also hold meetings with the power utility company on the arrangement of power supply to TCSS field equipment.

## 3. Identification of Special Hazards

### 3.1 Improvement in Design under CDM

The CDM process may lead to possible improvement in the design of the gantry and its associated full variable message sign. As pointed out in the Impacts Summary, hydraulic platform is a feasible solution. Another possible solution is the use of a movable working platform with the necessary safety guard can be constructed on top of the gantry to facilitate the transportation of maintenance personnel. Another design idea generated in the CDM process is the addition of a safety net under the gantry to catch any falling objects from the maintenance personnel.

It is recognized that the Contractor is the best designer of the work and the design improvement are from the suggestions from the TCSS Contractor.



### 3.2 Impacts Summary

The Impacts Summary is as Annex to Appendix I (Pre-tender Health and Safety Plan).

## 4. Documentation

### 4.1 Highlights

In the outline safety plan of the tender document, the attention of the tenderer is drawn to the permit-to-work requirement, method statements, traffic diversion and lane closure as described in the pre-tender safety plan.

There are a number of issues identified during the impact analysis phase of the project requiring attention from the tenderer, for instance, the use of hydraulic platform for maintenance of the full variable message sign. These issues are described in the Impact Analysis which is included as part of the Pre-tender Health and Safety Plan.

### 4.2 Pre-tender Health and Safety Plan

A copy of the Pre-tender Health and Safety Plan is attached in Appendix I.

## 5. Views

If CDM is to operate successfully in a project, prior training of the project officers and the whole design team on the relevant skills and techniques is a prerequisite. In addition, investment in terms of time and other resources to help the project officers and the whole design team to appreciate the value and advantage offered by CDM through worked examples should be worthwhile.

CDM can help to improve design and execution of a project where it involves site conditions with significant environmental and maintenance constraints. The advantage should be more apparent in civil engineering works and building construction works.



# *APPENDIX I*

## **Pre-tender Health and Safety Plan**

## APPENDIX I - PRE-TENDER HEALTH AND SAFETY PLAN

### Widening of Tolo Highway and Fanling Highway Traffic Control and Surveillance System

#### Pre-tender Health and Safety Plan

---

#### CONDITIONS OF TENDER

#### Clause XX. Outline Safety Plan

---

- (a) The tenderer shall submit with his Tender an Outline Safety Plan which shall be the tenderer's proposals to ensure safety and health in the execution of the Works.
- (b) The Outline Safety Plan shall start with a formal statement of policy on safety and health and shall include:
  - (1) identification of safety and health hazards which may be encountered in the execution of Works;
  - (2) an outline of proposed safety and health measures for the control and prevention of such safety and health hazards; and
  - (3) the manner by which safety and health measures will be implemented and monitored.
- (c) The Outline Safety Plan shall be used for the purpose of tender assessment and shall not form part of the Contract.
- (d) Attached at to the Special Conditions of Tender is the Pre-tender Health and Safety Plan prepared by the Project Design Team. The Pre-tender Health and Safety Plan will not form part of the Contract and is provided for information only to assist in the preparation of the Outline Safety Plan.

#### Pre-tender Health and Safety Plan

---

### 1. GENERAL

#### 1.1 Document

This document merely serves as a guideline to the tenderers, for the preparation of the Outline Safety Plan. It is to be read in conjunction with the associated tender specifications.

The health and safety consideration outlined herein had been included comprehensively in various parts of the tender document. This document is therefore regards as a summary of the health and safety items, for which the tenderers would have been taken into account.

### **1.2 Start of "Construction Phase"**

The Contractor should not commence the construction phase until he has adapted and developed his Safety Plan as stated in section 12 of this document. The Safety Plan should be submitted to the Engineer or his representative in sufficient time for their consideration.

### **1.3 Programme**

In preparing the detailed programme, the Contractor should allow for the adoption of safe working procedures and co-ordinate and rationalize activities to avoid uncontrollable hazards arising due to the clashes of activities.

### **1.4 Sub-Contractors, Suppliers & Designers**

The Contractor should ensure that all direct appointments in connection with this project include provisions for the compliance of his sub-contractors, suppliers and designers, etc, with the relevant provision of the Particular Specification for Site Safety in the Contract.

### **1.5 Liaison**

The Contractor should liaise with the Engineer or his representatives as required under the requirements of the Particular Specification for Site Safety and in connection with the preparation of the Safety Plan.

## **2. PROJECT DESCRIPTION**

### **2.1 Site Addresses**

The proposed sites for pump house and fresh water tank will be located at Tolo Highway and Fanling Highway between Ma Liu Shui Interchange and Wo Hop Shek Interchange.

### **2.2 Description of Work**

This project comprises the construction of Traffic Control and Surveillance Systems along the widened Tolo Highway and Fanling Highway between Ma Liu Shui Interchange and Wo Hop Shek Interchange. The work includes CCTV traffic surveillance cameras, vehicle incident detection stations, variable message sign, lan use signals, fibre optics communication network and a central control and monitoring system.

### **2.3 Estimated Duration of Construction Phase**

As stated in the Form of Tender.

## **3. INFORMATION REQUIREMENT**

The tenderers should provide the following information in the Outline Safety Plan.

### **3.1 General**

- A copy of his corporate Health & Safety Policy Document.
- An Outline Safety Plan to be submitted with the tender.

### **3.2 Management**

- Details of the personnel and systems to be put in place to prepare, manage, implement and monitor the Safety Plan for the project.
- Details of relevant qualifications and experience held by the persons nominated above, including recent health and safety education and training undertaken.
- Procedures for determining the competence of contractors engaged on the project, whether employed by the contractor directly or by others, to fulfil their duties under the Contract.

### **3.3 Programme**

- The Contractor should develop the Safety Plan within the first week after the commencement date, in order to ensure the set up of the site for the works to be carried out properly.

## **4. SITE CONDITIONS**

### **4.1 Site Location**

South Section and North Section are defined as follows:

#### **4.1.1 South Section**

The South Section is from Ma Liu Shui Interchange to Island House Interchange near Tai Po. Civil work on the widening of this section is complete before commencement of this Contract.

#### **4.1.2 North Section**

The North Section is from Island House Interchange near Tai Po to Wo Hop Shek Interchange near Fanling. Civil construction work will not be completed at commencement of this contract.

### **4.2 Existing Traffic System and Restriction**

The South Section is a dual 3-lane highway with a 3.3m wide hard shoulder in each direction. The North Section is originally a dual 2-lane standard highway. It will be upgraded by other contractors to a dual 3-lane standard including realigning the various slip roads. A 3.3m wide hard shoulder will also be provided where site conditions permit. The work will be held concurrently with the execution of the TCSS Contract.

For the South Section, construction work on the widening of the highway will be completed before commencement of the TCSS work. Site access to this section of the highway will be

from the 3.3m wide shoulder with possible closure of one lane. In this situation, it is necessary to apply protection to the working party and obtain permit from the Highways Department and the Transport Department. The duration of the closing of one lane will likely be during non peak hours and always subject to approval from the Transport Department, Traffic Police and the Highways Department. Traffic Impact Assessment will need to be produced if required by the Transport Department and Police for each lane closure application. In the event if the Contractor needs to close all lanes for the south section, traffic diversion will be necessary. A detail Traffic Impact Assessment with the proposed traffic diversion arrangement will need to be produced by the Contractor for acceptance by all concerned parties. The Contractor shall need to bear all costs associated with the application of the road closure application and its implementation.

The North Section will also be open to traffic as much as possible during the construction phase of the widening work. For the North Section, the Main Contractor responsible for the civil work will need to close section of the North Section from time to time. They will also make arrangement to close all lanes for some important construction work (e.g. erection of gantry). The existing footpath/trail is narrow. The TCSS Contractor may either take advantage of the road closure or lane closure obtained by the main contractor and carry out the necessary site installation work without the need to separately apply for lane close permit. However, the TCSS Contractor will need to be closely liaise with the main contractor and be prepared to adjust the program of its site to suite the road closure applied by the main contractor. Alternatively, the TCSS Contractor may wish to independently apply lane or road closure permit as per the South Section.

### **4.3 Existing Services**

Ductings and draw pit will be provided by the main contractor as part of the site construction. Gantries will be supplied and installed by the main contractors. The TCSS Contractor shall need to erect full variable message signs on gantries provided by the main contractor. In this respect, the TCSS contractor shall need to co-ordinate with the main contractor both on the design and implementation program. The TCSS contractor shall need to supply and install CCTV high masts on foundations constructed by the main contractor. The TCSS Contractor shall need to co-ordinate with the main contractor on the design and construction program of the high mast.

### **4.4 Adjacent Projects**

The Contractor and other contractors involved in the works should liaise and coordinate with any other parties carrying out works in the vicinity and with any others likely to be affected by the work on site. This may include other construction projects.

The Contractor should develop a suitable system to enable those who may be affected by relevant works to be informed in good time before the works start, so that they can make appropriate arrangement as necessary.

## **5. EXISTING DRAWINGS AND INFORMATION**

### **5.1 Existing Drawings**

The complete set of drawings relevant to this project is available for inspection at the Electrical and Mechanical Services Department.

### **5.2 Information Available for Inspection**

The Electrical and Mechanical Services Department will keep and make available for inspection information regarding the civil design of the widened highway at the office, and the information are only for reference purpose.

## **6. THE DESIGN**

### **6.1 Principal Hazards Identified by the Project Team**

This section is to list those hazardous operations / hazards, design assumptions, of work sequences which may be a risk to construction workers' health and safety, and which cannot be avoided. It may not be a comprehensive list of every hazard that may be present, but rather those hazards that the designers consider the most important, and the information that contractors may not be reasonably expected to know. The list does not include commonplace site hazards which are deemed to be familiar to the average competent contractor and can be controlled by normal good site management practices.

"The hazards identified in the design stage are outlined in the Impacts Summary (see Annex). Some of the hazards were already dealt with in the detailed design. Nevertheless, there are some unresolved hazards that need to be dealt with during construction. The Contractor shall take appropriate measures to eliminate, or reduce and control the risks created by the hazards given below or as stated in the Impacts Summary for addressing in the Safety Plan. Explanation of the proposed measures is to be included in the form of detailed method statements. Any other particular hazards in addition to those mentioned above are to be identified by the Contractor, who is to submit proposal as to how their associated risks may be controlled."

### **6.2 Contractor's Proposals**

The Contractor should take appropriate measures to eliminate or reduce and control the risks created by the hazards detailed below and in the Impacts Summary (See Annex 1) throughout this document. Explanation of the proposed measures is to be included in the form of detailed method statements. Any other particular hazards in addition to those above are to be identified by the Contractor, who is to submit proposal as to how their associated risks may be controlled.

## **7. SITE WIDE ELEMENTS**

### **7.1 Site Access and Egress**

- The Contractor should develop a Construction Access Strategy for the project.
- Materials and plant shall be stored away from means of access for the general public and local residents.
- Rubbish and demolition materials shall be removed regularly. Accumulation is not allowed on site.
- All practical measures shall be taken to minimize the close of traffic lanes to the public.

### **7.2 Deliveries**

The Contractor is to make proposal of the delivery strategy of the construction materials.

### **7.3 Emergencies**

Most of the works will be carried out along the Tolo Highway and Fanling Highway. The Contractor is to make proposal for the communication of his employees, Electrical and Mechanical Services Department's site staff and other sub-contractors working in the areas e.g. provision of mobile phones or walkie-talkie.

### **7.4 Location of Temporary Site Accommodation**

The Contractor is to note that no temporary site accommodation has been allowed in this contract and the Contractor shall make separate arrangement for the provision of temporary site accommodation for his employees, and other sub-contractors for the duration of the works necessary for the execution of the TCSS work.

### **7.5 Location of Unloading, Layout and Storage Areas**

The Contractor is to plan and co-ordinate the provision of unloading, layout and storage areas, to suit the methods of construction and work in progress, subject to the approval of the Engineer or his representatives.

Materials are to be unloaded and stored in locations which will not in any way affect access or egress to the site nor the works. In additions, all efforts shall be made by the Contractor to minimize the need for closing one or more traffic lanes on the Tolo Highway and Fanling Highway from the public.

### **7.6 Traffic and Pedestrian Routes**

The road, public footpaths are to be kept open at all times. All necessary signage and barriers are to be put in place to protect pedestrians at the site entrance and access and egress points. The Contractor should provide adequate separation between the works area and the public access.

### **7.7 Special Consideration to Welfare Facilities**

The Contractors should be fully conversant with the tender documents and will be required to develop proposals to respond to the health and safety requirements in this section.

### **7.8 Environment**

#### **Noise:**

After reviewing the work, it is considered that there are no particular activities likely to cause noise pollution to offices of households along the work site.

#### **Pollution:**

After reviewing the work, it is considered that there are no particular activities likely to cause water or air pollution to offices of households along the work site.

#### **Waste Disposal:**

The main type of waste is a small amount (say less than 10 cm for each site) of PVC type cable covers and some copper and optical fibre cable ends (again estimated to be less than 10 cm for each site). Refer to Particular Specification for the disposal of wastes.

### **7.9 Security**

- Ensure that all ladders and other means of access are removed at the end of each working day and locked in a secure area.
- Maintain a daily log of all site operatives and visitors to record time of arrival to site and departure from site.
- Issue all operatives with suitable identification badges to be worn and displayed at all times whilst on site.
- Immobilize plant at the end of each work period.

### **7.10 Safety**

- Ensure that all employees are aware of the safety policy and put into place arrangements to ensure that all visitors and workers new to the site are aware of the site safety provisions.
- Portable electric tools and equipment are to have special measures taken to protect them from mechanical damage and wet conditions.
- Locate underground electricity cables, mark and take precautions to avoid.
- Ensure that cartridge operated tools are operated by trained personnel and in accordance with the makers' instructions that the gun is cleaned regularly and kept in a secure place when not in use.
- Ensure waste material is removed regularly and that the site is kept tidy and materials stored safely.
- Ensure that all personnel can reach their place of work safely.



- Provide adequate artificial lighting when work is carried out after dark or inside building.
- Ensure that ladders are in good condition and that they are secured either at the top or bottom to prevent slipping. The ladders are to rise by at least 1.07m above their landing place.
- Provide adequate hydraulic platform vehicles to carry out the works ensuring that there is proper access, fully board working platforms, provide adequate guard rails and toe boards to every side which a person can fall more than 1.98m, that where loaded with materials, they are evenly distributed,

## **8. OVERLAP WITH CLIENT'S UNDERTAKING**

### **8.1 Works at High Level**

- Provide temporary protection to areas below to prevent injury from falling materials.

## **9. TEMPORARY WORKS**

### **9.1 Scaffolding and Working Platform**

The erection of scaffolding for installation of TCSS field equipment is not envisaged. However, the Contractor's attention is drawn to the use of hydraulic platform for transport working staff to the top of gantry for installation of TCSS field equipment.

### **9.2 Access Generally**

- Provide protections cones, warning boards, warning lights to divert traffic in accordance with the guide lines published by the Highways Department is necessary to protect personnel working along the highway.
- Provide safe access to site in form of temporary traffic arrangement with appropriate signage well in advance from location of work or keys to open up access gates for barriers along the highway.

## **10. SITE RULES**

### **10.1 Permit to Work Requirements**

On commencement of the works the Contractor will assume total responsibility for the site.

The Contractor is responsible for consulting statutory authorities as required by the various Regulations and standards with regards to close of traffic lanes. The Contractor should co-ordinate risk assessments related to the works and establish rules and procedures for health and safety issues arising. The site rules should include reference to the following issues:

- Control of persons gaining access to the site
- Briefing of persons gaining access to and working on the site
- Prohibition of Smoking and Alcohol
- Personal hygiene and protective clothing
- Radio and audio equipment
- Emergency procedures
- Site induction procedures with specific reference to Traffic Diversion, Site protection, Vehicles on Site and Use of Harnesses

The arrangements will be controlled and monitored by the Contractor to meet changing needs of the site personnel as appropriate to the site operations.

### **10.2 Injury**

- Maintain proper first aid facilities administered by qualified personnel.
- Make arrangements for all contractors to report accidents, ill health and dangerous occurrences notifiable to the Environment, Transport and Works Bureau.

## **11. METHOD STATEMENTS**

### **11.1 Access to Full Variable Message Sign (FVMS)**

The following are to be considered before implementation of the associated works:

- Provide general arrangement drawing for access to the components of FVMS detailing the consideration of safe access to electronics subsystems located near the top of the FMVS. In this aspect, possible use of cat ladders, safety harness and safety net mounted at the bottom of the FVMS can be considered. Another alternative is a movable working platform to be manually shifted from one end of the gantry to the other end allowing working staff to safety access electronics located near the top of the FVMS. The consideration on the choice of the access needs to take into account this issues of ease of access, safety, cost and inconvenience to the traffic.
- Co-ordination with the gantry supplier on the installation of FVMS to the gantry. The consideration includes the matching of the installation of the FVMS on site or off site, its program compatibility and additional night for the close of traffic for all lanes along the same direction of traffic.

### **11.2 Traffic Diversion and Lane Closure**

Method Statements should be submitted for any proposals for the erection and maintenance access of each type of TCSS field equipment stating if it will necessitate traffic diversion and lane closure for protection of the work site from traffic along the Tolo Highway and Fanling Highway. Description on the possible traffic diversion and its possible effect on traffic along the Tolo Highway and Fanling Highway is also needed.

## **12. CONTINUING LIAISON**

### **12.1 Procedures for the Health and Safety Implications of Contractors' Designs**

The procedures for consideration and evaluation of the health and safety implications of contractor designed elements of the works must follow the recognized principles of prevention and protection and take account of the issues highlighted in this outline of the Health and Safety Plan. The Contractor is to provide details of the hazards, and associated risk assessments to the Project Team before execution of the work.

Hazards arising from the use of temporary works to be identified and risk assessed by the Contractor in advance of the execution of the work.

Suitable and sufficient information to demonstrate that health or safety issues have been adequately considered.

#### **Risk assessments**

A list of health and/or safety hazards identified which cannot be designed out.

A list of any materials or substances which are specified or inherent in the design which are potentially hazardous to health and safety.

### **12.2 Procedures for Dealing with Design Changes**

Details of any re-design found to be necessary, together with details of the hazards and risk assessments should be issued in ample time before execution of the work. The Contractor is requested to submit the assessment to the Engineer or his representatives for approval and the subsequent incorporation into the Safety Plan.

### **12.3 Unforeseen Eventualities**

The following action is to be taken in the event of unforeseen eventualities arising during the construction stage of the project which require significant design changes, or affect the resources required to carry out the work without risk to health and/or safety, or have other health or safety implications.

The Engineer or his representatives and, where possible, the Contractor are to be advised as soon as possible.

Full details of the relevant health and safety issues involved are to be reviewed with the Safety Officer and the Contractor as soon as possible.

Full details of any revised designs, and risk assessments and identified hazards and/or hazardous materials and substances are to be issued to the Safety Officer and the Contractor in sufficient time to allow for the revision of the Health and Safety Plan and notification of all persons affected by the health and/or safety implications of the changes prior to the commencement of the affected works.

## 12.4 Safety Plan

Modify the Safety Plan to reflect variations in design or changes in site conditions and liaise with the Safety Officer.

The Contractor should develop Safety Plan so that it:

- a. Incorporates the Contractor's approach to managing the construction work to ensure the health and safety of all persons carrying out the construction work and all persons who may be affected by their work.
- b. Includes the risk assessments prepared by all Contractors.
- c. Includes the arrangements for ensuring that, where appropriate or specifically requested, all Contractors / Sub-Contractors prepare suitable and sufficient method statements for their construction works which incorporate adequate measures for ensuring the health and safety of all persons who may be affected by these works.
- d. Incorporates the common arrangements for site welfare, statutory notices and registers, etc.
- e. Includes the site rules to be adopted for controlling the risks to health and safety during the construction phase(s) or the project.
- f. Includes reasonable arrangements for monitoring compliance with health and safety legislation and site rules.
- g. Includes reasonable measures to ensure co-operation between all Contractors and Sub-Contractors in respect of health and safety provisions and prohibitions.
- h. Includes the steps to be taken to ensure that only authorized persons are allowed into any parts of the site / premises where construction works is being carried out.
- i. Includes arrangements for emergency procedures as required under the Health and Safety Regulations and the arrangements for displaying notices relating to these procedures.
- j. Includes arrangements for ensuring that, so far as is reasonably practicable, every Contractor and Sub-Contractor is provided with comprehensible information about the risks to health and safety of that Contractor / Sub-Contractor, or of any employees or other persons under the control, arising out of the construction works, including the emergency procedures.
- k. Includes details of the arrangements for ensuring, so far as is reasonably practicable, that the employees or other persons under the control of any Contractor / Sub-Contractor, and visitors to the site, receive adequate information about the risks to their health and safety arising out of the construction works and, where necessary, adequate training to carry out their work in a safe and healthy manner.
- l. Includes arrangements for providing all persons at work on the site and visitors to the site with the opportunity and means of discussing and offering advice on health and safety issues relating to the construction works.
- m. Includes arrangements for the reporting of any accidents, injuries or dangerous occurrences.

- n. Can be modified as the work proceeds to take into account of any information received from Contractor / Sub-Contractors, any experience gained during the course of the project or any changes necessary as a result of unforeseen circumstances or alterations to the design.

### **12.5 Site Liaison**

Liaison with all other contractors and implement any agreed changes to the Safety Plan arising from such liaison. Set up regular training for all operatives including induction training for all staff upon arrival to site.

### **12.6 Health and Safety File**

Provide the Project Team with any relevant information which the contractor believes should be incorporated into the Health and Safety File.

### **12.7 Design Development**

Provide the Project Team with all design information prepared by sub-contractors; arranging liaison meetings with sub-contractors to discuss and review health and safety issues arising from the sub-contractors' designs.

### Annex 1 - Impacts Summary

**Project Title : Traffic Control and Surveillance System for the Tolo Highway Widening between Island House Interchange and Fanling**

Activity	Description of Impact	Classification Code (See footnote below)	Impact Resolved Yes/No	If yes, please state the control measures	Endorsement by Design Reviewer
Installation and commissioning of Full Variable Message Sign (FVMS)	During installation of FVMS, the sign hits the noise protection barrier	S	Yes	Contractor to provide in the Safety Plan the method statement for the erection of the FVMS for the acceptance of the Engineer before commencement of erection. This is part of the contract requirement. Use of heavy duty hydraulic crane and hydraulic platform can be considered.	✓
	During installation of FVMS, the sign falls down and hits worker	S	Yes	Contractor to provide in the Safety Plan the method statement for the erection of the FVMS for the acceptance of the Engineer before commencement of erection. This is part of the contract requirement. The Contractor can consider possible use of safety net underneath of the Gantry. It is also possible to use a mobile platform, propelled manually in the horizontal direction with safety net constructed underneath the platform.	✓
	FVMS not secure and fall on the highway	S	Yes	Contract requires the Contractor to provide calculation and site inspection report on the installation of the FVMS. Certification of the calculation by RPE will be required.	✓
	Workman while drawing the FVMS cable hit by traffic on the highway	S	Yes	The Contract Specification to require the Contractor to provide in the Safety Plan the method statement covering the procedure in drawing FVMS cable. Close of at least one traffic lane can be considered.	✓
	Power not available for operating the sign	B	Yes	During the design stage, each location be examined on the power availability. The route for the supply of power will be reviewed to-gather with power company. The extent of work required by the TCSS Contractor to connect up power from the CLP cut out point to the FVMS equipment will be defined and incorporated as part of the Contract.	✓

Classification Code : Safety (S) ; Environmental Protection (EP) ; Buildability (B) and Maintainability (M)

WORKED EXAMPLE NO. 4 - Appendix

Activity	Description of Impact	Classification Code (See footnote below)	Impact Resolved Yes/No	If yes, please state the control measures	Endorsement by Design Reviewer
	Maintenance access to FVMS	M	Yes	During the design stage, maintenance walkway will be provided for FVMS on gantry. Hydraulic vehicles can be used to transport maintenance staff to from ground level to the walkway. For 2 special FVMS where walkways cannot be provided, arrangement to use hydraulic platform to transport maintenance staff to the location of work with the corresponding road closure procedure will be required. Alternatively, the Contractor may consider the installation of a mobile working platform propelled manually and moved in the horizontal direction. The mobile platform can be of two levels with safety net constructed under the platform to catch any fallen objects.	✓
Installation and commissioning of Closed Circuit Television (CCTV)	During installation of CCTV high mast, the high mast hits the noise protection barrier	S	Yes	Contractor to provide in the Safety Plan the method statement for the erection plan for the erection of the high mast for the acceptance of the Engineer before commencement of erection. This is part of the contract requirement.	✓
	During installation of CCTV high mast, the high mast falls down or hits worker	S	Yes	Contractor to provide in the Safety Plan the method statement for the erection of the high mast for the acceptance of the Engineer before commencement of erection. This is part of the contract requirement.	✓
	High mast not secure and falls on the highway	S	Yes	Contract requires the Contractor to provide calculation and site inspection report on the installation of the high mast. Certification of the calculation by RPE will be required.	✓
	Workman while drawing the CCTV hit by traffic on the highway	S	Yes	The Contract Specification to require the Contractor to provide in the Safety Plan the method statement covering the procedure in drawing CCTV cable	✓
	Location of the high mast cannot be accessed by vehicle to erect the high mast	B	Yes	During the design stage, each CCTV high mast location to be checked to ensure it is accessible.	✓
	Power not available for operating the high mast	B	Yes	During the design stage, each location be examined on the power availability. The route for the supply of power will be reviewed to-gather with power company. The extent of work required by the TCSS Contractor to connect up power from the CLP cut out point to the CCTV equipment will be defined and incorporated as part of the Contract.	✓

Classification Code : Safety (S) ; Environmental Protection (EP) ; Buildability (B) and Maintainability (M)

**Widening of Tolo Highway and Fanling Highway  
- Traffic Control and Surveillance System**

Activity	Description of Impact	Classification Code (See footnote below)	Impact Resolved Yes/No	If yes, please state the control measures	Endorsement by Design Reviewer
	Maintenance access to high mast	M	Yes	During the design stage, each CCTV high mast location to be checked to ensure it is accessible by maintenance.	✓
Installation and commissioning of Vehicle Detection Device	During installation of vehicle detector device, the device falls down or hits worker	S	Yes	Contractor to provide in the Safety Plan the method statement for the erection of the device for the acceptance of the Engineer before commencement of erection. This is part of the contract requirement.	✓
	Vehicle detection device not secure and fall on the highway	S	Yes	Contract requires the Contractor to provide calculation and site inspection report on the installation of the vehicle detector. Certification of the calculation by RPE will be required.	✓
	Workman while drawing the vehicle detection device hit by traffic on the highway	S	Yes	The Contractor Specification to require the Contractor to provide in the Safety Plan the method statement covering the procedure in drawing vehicle detection cable	✓
	Location of the vehicle detector cannot be accessed by vehicle to install the detector	B	Yes	During the design stage, each vehicle detection location to be checked to ensure it is accessible.	✓
	Power not available for operating the vehicle detector	B	Yes	During the design stage, each location be examined on the power availability. The route for the supply of power will be reviewed to-gather with power company. The extent of work required by the TCSS Contractor to connect up power from the CLP cut out point to the Vehicle Detector equipment will be defined and incorporated as part of the Contract.	✓
	Maintenance access to the vehicle detector	M	Yes	Hydraulic vehicle to be used to transport maintenance to access the detector mounted on the pole. Lane closure procedure shall be in accordance with established road closure procedure.	✓
Installation and commissioning of Variable Speed Limit Sign (VSLs)	During installation of VSLs, the sign falls down or hits worker	S	Yes	Contractor to provide in the Safety Plan the method statement for the erection of the VSLs for the acceptance of the Engineer before commencement of erection. This is part of the contract requirement.	✓
	VSLs not secure and falls on the highway	S	Yes	Contract requires the Contractor to provide calculation and site inspection report on the installation of the VSLs. Certification of the calculation by RPE will be required.	✓

Classification Code : Safety (S) ; Environmental Protection (EP) ; Buildability (B) and Maintainability (M)



WORKED EXAMPLE NO. 4 - Appendix

Activity	Description of Impact	Classification Code (See footnote below)	Impact Resolved Yes/No	If yes, please state the control measures	Endorsement by Design Reviewer
	Workman while drawing the VLSL cable hit by traffic on the highway	S	Yes	The Contractor Specification to require the Contractor to provide in the Safety Plan the method statement covering the procedure in drawing VLSL cable.	✓
	Power not available for operating the VLSL	B	Yes	During the design stage, each location be examined on the power availability. The route for the supply of power will be reviewed to-gather with power company. The extent of work required by the TCSS Contractor to connect up power from the CLP cut out point to the VLSL equipment will be defined and incorporated as part of the Contract.	✓
	Maintenance access to VLSL	M	Yes	During the design stage, maintenance walkway will be provided for VLSL on gantry. Hydraulic vehicles will be used to transport maintenance staff to from ground level to the walkway.	✓
Relocation of Speed Camera	During relocation of the camera structure, it falls down or hits worker	S	Yes	Contractor to provide in the Safety Plan the method statement for the erection of the device for the acceptance of the Engineer before commencement of erection. This is part of the contract requirement.	✓
	The camera structure not secure and falls on the highway	S	Yes	Contract requires the Contractor to provide calculation and site inspection report on the installation of the camera structure. Certificate of the calculation by RPE will be required.	✓
	Workman while drawing power cable for the speed camera hit by traffic on the highway	S	Yes	The Contractor Specification to require the Contractor to provide in the Safety Plan the method statement covering the procedure in drawing power cable for the speed camera	✓
	Location of the speed camera cannot be accessed by vehicle to install the camera or structure	B	Yes	During the design stage, each speed camera structure location to be checked to ensure it is accessible.	✓
	Maintenance access to the speed camera	M	Yes	Orientation of the structure is such that when the speed camera is lowered, the maintenance personal need not stand near the traffic in order to maintain or operate the equipment. No lane closure is necessary.	✓

Classification Code : Safety (S) ; Environmental Protection (EP) ; Buildability (B) and Maintainability (M)

CDM

*WORKED EXAMPLE No. 5*

*Footbridge Across Po Kong Village Road  
at Junction with Tsz Wan Shan Road*

Highways Department

## CONTENTS

---

<b>1. Project Information</b>	<b>121</b>
1.1 Scope of Works	
1.2 The Design Team	
<b>2. Site Environment and Nature of the Works</b>	<b>122</b>
2.1 Site Environment	
2.2 Liaison Activities	
<b>3. Identification of Special Hazards</b>	<b>124</b>
3.1 Improvement in Design under CDM	
3.2 Impacts Summary	
<b>4. Documentation</b>	<b>125</b>
4.1 Highlights	
4.2 Pre-tender Health and Safety Plan	
<b>5. Views</b>	<b>125</b>
5.1 Suggestions	
5.2 Comments	
 Appendix I - Pre-tender Health and Safety Plan	 126

## 1. Project Information

### 1.1 Scope of Works

The scope of the project comprises the construction of a covered footbridge of 4-metre clear width across Po Kong Village Road at the junction with Tsz Wan Shan Road, including the associated piling, landscaping, drainage and electrical & mechanical works (the majority of which are the escalators and the lifts).

Photomontages of the project are shown in Figures 1 and 2, and the scope of works is illustrated in Figure 3. A location plan is attached as Annex A to Appendix I (Pre-tender Health and Safety Plan).



Figure 1: Perspective View of the Proposed Footbridge (North Elevation)



Figure 2: Perspective View of the Proposed Footbridge (South Elevation)

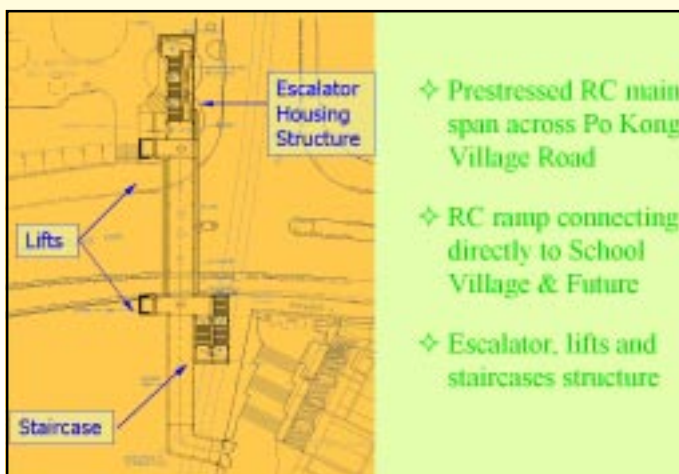

Figure 3: Scope of Project

## 1.2 The Design Team

The design team comprises a senior engineer and an engineer in the Project Section of the Structures Division of the Highways Department.

## 2. Site Environment and Nature of the Works

### 2.1 Site Environment

Po Kong Village Road is a single four-lane carriageway with two lanes on each bound. At the junction with Tsz Wan Shan Road, there is an existing staggered crossing controlled by signals across Po Kong Village Road. The works area is very congested particularly in the northern portion of the site. There is a small garden along Tse Wan Shan Road which may have to serve as works area (Figures 4 and 5).



Figure 4: Road junction of Po Kong Village Road and Tsz Wan Shan Road



Figure 5: Tsz Wan Shan Rest Garden

In view of the site environment and the works processes, we have identified several major hazards:

1. Construction vehicles and working at height will cause hazards to road users.
2. The erection of hoardings around the works area will cause a sight line problem to road users.
3. Piling works and the use of generators will cause noise nuisance to adjacent schools.

4. Dust and wastewater will be generated during construction works.
5. Post-tensioning operation within a congested working environment will be a potential hazard.
6. Limited space within the footbridge, tight access and working at height over a road would cause problems to maintenance of planters and the roof.

## 2.2 Liaison Activities

In the design stage, design team members have met frequently to identify potential hazards, propose improvement measures and review the design whenever necessary. For instance, the main span of the footbridge is designed to be a precast and prestressed concrete beam with an aim to minimize hazards arising from working at height and adverse impacts on existing traffic. Mini-piles are adopted because of the limited working space and the need to mitigate exposure to construction noise by the public. Moreover, the hoarding has been designed to avoid blocking the sight line of drivers at the road junction.

In addition, the design team have closely liaised with the relevant interested parties as listed in Table 1.

Table 1 - Liaison

Interested Parties	Issue concerned
Transport Department	<p><b>Ingress and Egress Arrangements</b></p> <p>"Left-in Left-out" restriction at site access should be adhered to during construction works. Cross-lane traffic at the junction will not be allowed and hence construction vehicles should gain access into the works site within Tsz Wan Shan Road's rest garden from the eastbound of Po Kong Village Road to the north.</p>
Leisure and Cultural Services Department (LCSD) & District Lands Office (DLO)	<p><b>Works Area</b></p> <p>Agreement from LCSD and DLO has to be obtained for providing sufficient working space at Tse Wan Shan Road's rest garden. A contractor's works area will also be provided at the southern side of Po Kong Village Road. The contractor should plan the loading/unloading points and storage areas to suit his methods of construction.</p>
LCSD	<p><b>Tree preservation</b></p> <p>The trees that will need to be transplanted or retained have to be agreed with LCSD.</p>

### 3.1 Improvement in Design under CDM

In the preliminary design stage, the concrete planters on the bridge deck were originally placed alongside the main span of the footbridge. The concrete planters would be separated from the bridge deck by railings. At the review in the CDM meetings and the subsequent consultations with the maintenance authorities and concerned parties, we received comments on the need for the provision of safe maintenance access for the plants in the planters in the detailed design stage. The design team substituted the concrete planters by GRP planter boxes with lifting handles so that a 400 mm wide maintenance walkway could be reserved between the planter boxes and the railings without altering the width of the footbridge. Moreover, lockable openings were provided at the ends of the main span for the ease of maintenance. The improvements are illustrated in Figure 6.

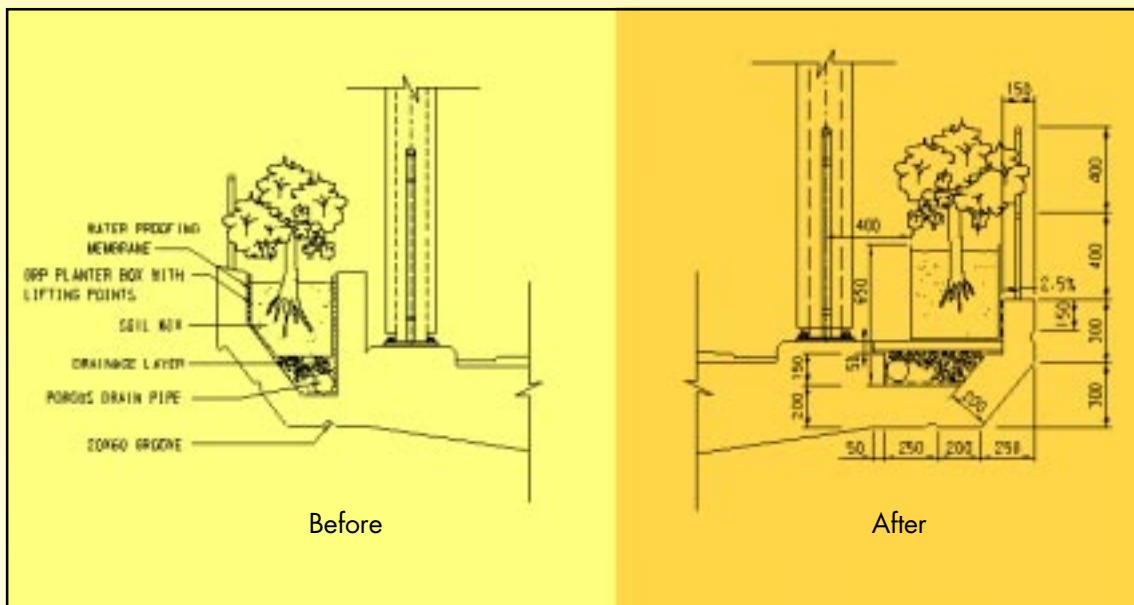

Figure 6: Improvement to Edge Planter Design (Safer and easier access for maintenance)

In the CDM meetings, the design team were also advised to pay attention to the location of the anchorages for fall protection system at the roof for future maintenance and to study the feasibility of the use of precast units for staircase and lift housings in view of the limited working spaces. The design team then revised the location of the anchorages from the edge to the center of the roof and allowed in the tender documents the tenderers to propose alternative design with precast units for staircase and lift housings.



### 3.2 Impacts Summary

The Impacts Summary is as Annex D to Appendix I (Pre-tender Health and Safety Plan)

## 4. Documentation

### 4.1 Highlights

In the Contractor's Outline Safety Plan, the following items shall be addressed, based on the Pre-tender Health & Safety Plan:

- (a) Ingress and egress arrangements of the site
- (b) Safety provisions for pedestrians to protect against working at height hazards.
- (c) Proper arrangement for piling works with particular attention to the nearby schools.
- (d) Waste management and dust and wastewater prevention.
- (e) Risk assessment and safety measures in respect of post-tensioning operation.
- (f) Care of the existing trees.
- (g) Alternative designs with precast units for staircase and lift housings in view of limited working spaces.

### 4.2 Pre-tender Health and Safety Plan

A copy of the Pre-tender Health and Safety Plan is attached in Appendix I.

## 5. Views

### 5.1 Suggestions

Kick-off meetings and progress meetings of CDM for government projects are recommended to be attended by senior engineers/safety officers of all relevant parties, including those from the side of the designer, and future maintenance and management agencies.

### 5.2 Comments

CDM provides a useful forum for relevant parties to review the design at the preliminary design stage.



# *APPENDIX I*

## **Pre-tender Health and Safety Plan**

## APPENDIX I - PRE-TENDER HEALTH AND SAFETY PLAN

### Footbridge Across Po Kong Village Road at Junction with Tsz Wan Shan Road

#### Pre-tender Health and Safety Plan

---

## 1. INTRODUCTION

This safety plan provides information on managing safety and health throughout the design and construction of a project. Its purpose is to highlight the main safety and health issues in connection with the construction work on the project. This will also enable tendering contractors to respond more specifically on how to deal with and control any residual hazards and risks which cannot be eliminated in design stage.

## 2. NATURE OF THE PROJECT

### 2.1 Parties to the Project

Client : Transport Department of HKSAR

Works Agency : Highways Department of HKSAR

### 2.2 Location

#### 2.2.1 Site location and boundaries

The site is located at the junction of Po Kong Village Road and Tsz Wan Shan Road. The location plan is shown in Annex A.

#### 2.2.2 Present site usage

Part of the site in the north of Po Kong Village Road is currently occupied by a rest garden, namely the Tsz Wan Shan Road Rest Garden. In addition, a site which has been reserved for the future development of a clinic adjoins the western side of the school village.

#### 2.2.3 Proposed development

A covered footbridge will be constructed across Po Kong Village Road. Its objective is to provide a safe, direct and convenient grade-separated crossing from Tsz Wan Shan North to the new development in the southern side including a school village and a future clinic. It not only eliminates the conflict between the large amount of pedestrians and vehicles, but also alleviates the traffic congestion at the junction.

### **2.3 Nature of the Work**

The footbridge comprises the construction of a 25 m long, 4 m wide main span across Po Kong Village Road. There will be a lift and a staircase on both ends of the main span. To accommodate the high pedestrian flow, an escalator will be provided on the northern side while a 20 m long ramp will be constructed on the southern side directly connected to the western entrance of the school village and future clinic. The scope of the project also includes associated geotechnical, landscape, drainage and E&M works.

There are no construction works currently underway in the surrounding area.

### **2.4 Programme of the Work**

Originally, the construction works are scheduled to commence in mid 2003 for completion in early 2005. However, the programme of the works has been deferred and is subject to review by the Project Office.

## **3. THE EXISTING ENVIRONMENT**

### **3.1 Surrounding Land Uses and Related Restrictions**

Po Kong Village Road is a single four-lane carriageway with two lanes on each bound. At the junction with Tsz Wan Shan Road, there is an existing staggered pedestrian crossing controlled by signals across Po Kong Village Road.

A college, a rest garden and a bus terminal are located along the northern side of Po Kong Village Road. On the southern side of Po Kong Village Road, there is a school village comprising three aided primary schools, an aided secondary school and a private independent school.

### **3.2 Existing Services**

The relevant utility companies and government offices have been consulted regarding the locations and details of the existing underground utility services in the vicinity of the proposed footbridge. As revealed from the utility records, all existing utility services are under the footpath and carriageway. It is anticipated that utility diversion would be minimal.

However, it should be highlighted that an existing effluent tunnel with an internal diameter of 3.18 m lies directly underneath the site at a level of 22.7 mPD which is approximately 60 m deep including a 30 m bedrock cover. Geotechnical assessments prepared by the Advisory Division of GEO concluded that the site investigation and foundation works for supporting the footbridge would not cause any adverse effects on the effluent tunnel.

### **3.3 Existing Traffic Systems and Restrictions**

A traffic impact assessment (TIA) has been conducted by a traffic consultant commissioned by Architectural Services Department. It was assessed in the TIA that a very high pedestrian flow of about 1175 and 1505 school students would use the footpath and the crossings to access the schools during 15 minutes peak in the morning and afternoon respectively.

## 4. EXISTING DRAWINGS AND INFORMATION

### 4.1 Site History

Ground investigation for the following projects in the vicinity, which are stored in the database of GIU in the Geotechnical Engineering Office (GEO), will provide useful information in respect of the geological setting of the site.

GIU Ref.	Title of G.I. Report
7632	Diamond Hill Development Work Area 8
12865	Tsz Wan Shan Development
30804	One 20 Classroom Primary School (P3) at Po Kong Village Road, Kowloon
34429	Footbridge across Po Kong Village Road at junction with Tsz Wan Shan Road

### 4.2 Existing Drawings

Existing topographical and geotechnical surveys and reports are available from the Project Office - Kowloon Regional Office of Highways Department. For the current available drawings, refer to the tender document.

## 5. THE DESIGN

### 5.1 Significant Hazards

This section is to list those hazards, design assumptions, or work sequences which may be a risk to construction workers' safety and health, and which cannot be avoided or designed out. It may not be a comprehensive list of every hazard that may be present, but rather those hazards are considered most important, and the information that the Contractor may not be reasonably expected to know.

A summary of General Design Considerations for general site activities and works to be carried out on site during construction, operation & maintenance is provided in Annex B.

### 5.2 Design Principles

#### 5.2.1 Construction Method and Sequence for Bridge Deck Construction

Works area will be at the planned site of clinic locating at the western side of school village. The main deck of the footbridge structure can be precast off site at ground level within the works area and subsequently lifted into position by cranes at night-time. As such, the potential hazard of working at height can be reduced and the disturbance to the existing traffic will be kept to a minimum. The main span can also be constructed by using conventional cast in-situ method. However, headroom clearance of 4700 mm with adequate signing should be maintained during construction of the main span across the carriageways.

Temporary full road closure and/or partial road closure will be required. During construction, the Contractor will be responsible for preparing submission of temporary traffic arrangements to Transport Department and the Hong Kong Police Force for comments if considered necessary.

### **5.2.2 Construction Method and Sequence for Other Structures**

For the rest of the footbridge system, including columns, staircases, escalator housing structure and lift shafts, ramp and abutment, they are basically constructed by cast in-situ method using conventional formwork and concreting technique. Since these in-situ reinforced concrete structures are off the road, there is only minimal effect of its construction to the existing traffic. However, safe working platforms complying with safety standard should be provided during construction stage.

For roof construction, the Contractor can choose either in-situ erection or pre-fabricated off-site and then install above the deck on site. If the former construction option is adopted, the Contractor should provide a safe working platform along both side of the structure.

### **5.2.3 Foundation Works**

During excavation for substructure, the Contractor should be aware of the existing utility cables beneath ground, especially those would impose danger to workers, e.g. gas mains and high voltage cables. The Contractor should identify the utility cables/mains in advanced and should take appropriate measures to protect the cables/mains as well as prevent the workers from those dangers.

Mini-piles will be adopted for the foundation of the footbridge system. As smaller drilling machines will be required, this can avoid the use of heavy-duty boring machines in congested areas, particular in the works area within Tsz Wan Shan Road Rest Garden. It can also minimize the generation of excessive noise and significant vibration in rock mass which might have adverse effect on the existing effluent tunnel.

The Contractor shall schedule the foundation piling works to be carried out outside the examination periods to minimize the probable nuisance to students in the nearby schools.

### **5.2.4 Environmental Protection**

During construction, the Contractor should control any sewage, wastewater or effluent to flow from the Site onto any adjoining land, especially the wastewater generated from piling operation and wheels washing facilities.

The Contractor is required to liaise with Environmental Protection Department for the application of noise permit in order to minimize the noise impact to the sensitive receivers such as students and residents. Noise barrier will be required if consider necessary.

In the southeast of the rest garden, there are some trees that would be inevitably affected by the footbridge. Every effort should be made to either retain or transplant the trees as shown on the Landscape Plan and Planting Design. If necessary, the Contractor should seek advice from Leisure and Cultural Services Department and Landscape Unit of Highways Department on how to properly retain and maintain the trees during construction stage.

### **5.3 Specific Hazards / Residual Risks**

The Contractor is required to take appropriate measures to eliminate or reduce and control the risks created by the hazards detailed in the Project Specific Design Considerations and the Impacts Summary as attached in Annex C and Annex D respectively. These hazards are stated here only to the extent necessary to enable a competent contractor to identify safety and health issues relating to key areas and to assess the risks, and to put into place methods to manage them.

The Contractor is required to elaborate further and provide proposals to either eliminate or mitigate the residual risks which cannot be avoided or designed out including amongst others;

- (a) working on, over or near existing live traffic;
- (b) working at height;
- (c) tensioning of prestressing tendons; and
- (d) generation of nuisance such as noise, wastewater and dust, etc.

## **6. SITE WIDE ELEMENTS**

### **6.1 Site Access and Egress Points**

Site access and egress points have been discussed with Transport Department. The criterion of "left-in left-out" restriction for construction vehicles should be adhered to during the course of construction. The Contractor may propose other traffic arrangement for construction vehicles and shall develop a Construction Access Strategy for the project.

#### **6.1.1 Northern site access and egress points**

As cross-lane traffic at the junction will not be allowed for the sake of road safety, construction vehicles should gain access into the works area from Po Kong Village Road and exit from Tsz Wan Shan Road. It is anticipated that impacts on pedestrian movement along Yuk Wah Street can be minimized.

#### **6.1.2 Southern site access and egress points**

Access in and out of the site in the south of Po Kong Village Road is expected from Po Kong Village Road.

## **6.2 Location of Temporary Site Accommodation**

The Contractor is required to prepare a proposal for the provision and location of temporary site accommodation during the works complying with the Specifications.

The fire and emergency access must be maintained at all times.

## **6.3 Location of Unloading, Layout and Storage Area**

The Contractor is required to plan and co-ordinate the provision of unloading, layout and storage areas, to suit the methods of construction and work in progress complying with the Specifications.

## **6.4 Traffic/Pedestrian Routes**

Temporary pedestrian routes are to be provided so that the pedestrian flow can be adequately maintained. Clear signage depicting the temporary routes should be provided on site.

All routes are to be agreed with the Engineer where necessary before the works commence including any closure, partial restriction or alteration to the agreed route. Temporary traffic arrangement will be carried out if necessary.

## **6.5 Emergency Routes**

The Contractor shall ensure that site operations will never obstruct fire or other emergency services or escape routes.

## **6.6 Special Consideration to Welfare Facilities**

To take care of the needs and welfare of workers, the Contractor will be required to develop proposals to respond to the safety and health requirements in this section.

The Contractor shall provide storage compartments, drinking water facilities, toilet facilities, hand-wash facilities and rubbish bins on the Site.

The Contractor shall also arrange and provide a hard-paved area, which shall be designed to be able to sustain the load at that area throughout the Contract, on the Site. The hard-paved area can be an open area in front of the site office, or an area inside building structure under construction, or at the main works areas. The Contractor shall maintain the hard-paved area and the cover throughout the Contract, and shall demolish and reinstate the area prior to completion of the Works.

## **7. OVERLAP WITH CLIENT'S UNDERTAKING**

There is no specific overlap with the clients undertaking on this site as the site is not and will not be partially occupied by the clients.

## **8. SITE RULES**

On commencement of the works, the Contractor shall assume total responsibility for the site.

The rules and requirements as set out in the contract documents for safety and health shall be followed at all times. These shall be included in the Safety Plan for the execution of the works.

The Contractor shall carry out risk assessments related to the works and establish rules and procedures for safety and health issues arising.

The arrangements shall be controlled and monitored by the Contractor to meet changing needs of the public and site personnel as appropriate to the site operations.

## **9. CONTINUING LIAISON**

### **9.1 Procedures for Safety and Health Implications of Contractor's Designs**

- (a) The Contractor should provide details of the hazards, and associated risk assessments before execution of the work.
- (b) Hazards arising from the use of temporary works should be identified and the risk should be assessed by the Contractor in advance of the execution of the work.
- (c) Details of any re-design found to be necessary, together with details of the hazards and risk assessments should be issued in ample time before execution of the work.

### **9.2 Procedures for Dealing with Unforeseen Eventualities**

- (a) As soon as an unforeseen eventuality arises during project execution resulting in substantial design change which might affect the resources, design or timescale for the work, the Contractor should notify the Project Office.
- (b) Details of the hazards, together with details of the risk assessments, arising from the eventuality are to be submitted by the Contractor to the Project Office as soon as possible after the occurrence.

### **9.3 Safety and Health Plan**

During the construction phase, the Safety and Health Plan is the responsibility of the Contractor. Safety and health must be an agenda item in the site meetings.

### **9.4 Safety and Health File**

The Safety and Health File is a consolidated document and will be consistent with the Safety and Health Plan that describe the safety and health information available.

The Contractor shall provide relevant information to the Safety and Health File during the progress of the work with the aim that there should be no outstanding information by completion of the construction of the property. Such information may be design criteria, selected "as built" drawings, general details of methods and materials used, details of any ongoing actions and requirements, and details of the location and nature of utilities and services.



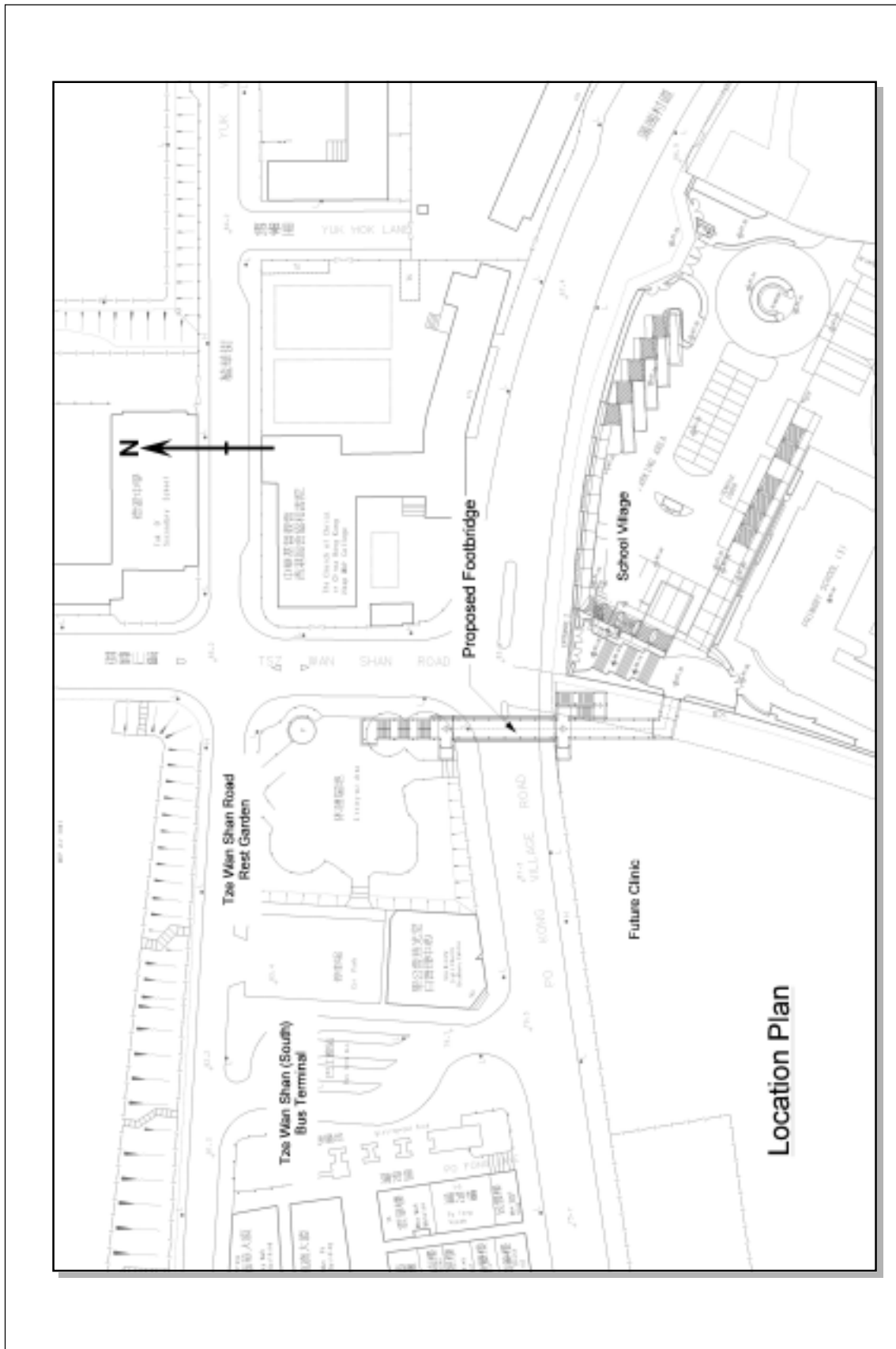

## ANNEX B - GENERAL DESIGN CONSIDERATIONS

### (A) General Site Activities

- (1) Site Logistics
  - (a) Storage, handling, use and disposal of materials, in particular waste management.
  - (b) Works area, site office and accommodation.
- (2) Public Safety & Impact
  - (a) Pedestrians, particularly school children.
  - (b) Road users.
  - (c) Public facilities including consideration for the disabled, e.g. bus terminal & stops, rest garden, traffic signs and signals.
  - (d) Parking of construction vehicles.
- (3) Environmental Control
  - (a) Noise - noise sensitive receivers, e.g. schools, residents.
  - (b) Visual impact, e.g. noise barrier.
  - (c) Promotion of greening and preservation of trees
  - (d) Slope - stability.
- (4) Layout
  - (a) Provision for the disabled, including lift and escalator.
  - (b) Impact on pedestrians during maintenance of lift and escalator (if provided)
  - (c) Convenience of connection to public facilities.
  - (d) Public promotion and customer satisfaction.

### (B) Construction

- (1) Site Formation
  - (a) Environmental protection - impact due to dust suppression, noise, etc.
  - (b) Safety - considerations on utilities, machine and equipment (e.g. bulldozer, truck, excavators, etc), human and vehicular access, excavated collapse and erosion.
- (2) Piling
  - (a) Environmental protection - impact due to dust suppression, noise, wastewater or muddy water (e.g. spraying and provision of sedimentation tank).
  - (b) Safety - considerations on lifting operation, plant safety, etc.
- (3) Landing Structure
- (4) Span Construction

### (C) Operation and Maintenance

- (1) Consideration to Facilitate Community Provision and Dismantling
  - (a) Lift and escalator.
  - (b) Greening, e.g. planter and water points.
  - (c) Cleaning, e.g. span, landing, roof, drains, etc.
  - (d) Lighting.
- (2) Consideration to Facilitate Structural Maintenance
  - (a) Bearings.
  - (b) Movement joints.

## ANNEX C - PROJECT SPECIFIC DESIGN CONSIDERATIONS

### NORTHERN PART / LANDING

#### (A) General

- (1) Site logistics
  - (a) Congested Site - size of works area.
  - (b) Insufficient space for maneuvering of machinery plant and equipment.
- (2) Environmental control (greening)

Damage to tree needed to be retained & maintained.
- (3) Pedestrian / Public safety.
  - (a) Safety of pedestrian.
  - (b) Safety of road users at site access.

#### (B) Construction

- (1) Site formation and piling works

Hindrance on piling works due to erection of hoarding.
- (2) Lift and escalator
  - (a) Consideration of precast unit for the lift shaft and escalator housing.
  - (b) Lift and escalator maintenance.

### MAIN SPAN

#### (A) General

- (1) Traffic impact
- (2) Safety impact
  - (a) Safety during future maintenance of soft landscaping works on edge of planter.
  - (b) Safety during roof construction.

#### (B) Construction

- (1) Lifting operation

Consideration of precast unit for main span.
- (2) Consideration of lifecycle cost

Procedures in post-tensioning the tendons of the main deck.

#### (C) Maintenance

- (1) Consideration on the provision of proper safe access for maintenance works
- (2) Consideration of lifecycle cost

### SOUTHERN PART / LANDING

#### (A) General

- (1) Environmental Control (Nuisance)
  - (a) Generation of wastewater during excavation and piling works.
  - (b) Noise nuisance to sensitive receivers e.g. students and residents.
  - (c) Dust nuisance to pedestrian walking adjacent to the works site.
- (2) Public Safety
  - (a) Safety of pedestrian.
  - (b) Safety of road users at site access.

#### (B) Construction

- (1) Site formation and piling works

Hindrance on piling works due to erection of hoarding.
- (2) Lift and escalator.
  - (a) Consideration of precast unit for the lift shaft and escalator housing.
  - (b) Lift and escalator maintenance.

### ANNEX D - IMPACTS SUMMARY

#### Impacts Summary

**Project Title : PWP Item No. 152TB - Footbridge across Po Kong Village Road at Junction with Tsz Wan Shan Road**

**Main Activity : General Site Activities**

Classification Code (See footnote below)	Key Word Development	Description of Impact	Impact Resolved Yes/No	If yes, please state the control measures	Endorsed by Design Reviewer Yes/No
S	Ingress / Egress arrangements	Safety of road users at site access	Yes	"Left-in left-out" restriction at site access should be adhered to during construction works. Cross-lane traffic at the junction will not be allowed and hence construction vehicles should gain access into the works site within Tsz Wan Shan Rest Garden from the eastbound of Po Kong Village Road and exit from Tsz Wan Shan Road to the north. Provision of revolving amber lights and chain across footpath will be considered if necessary.  The layout of hoardings should be designed to avoid blocking the sight line of drivers at the road junction.  Hoarding will be erected in such a way that it will not impinge upon the construction of piling works for the northern pier and at the same time, a safe sight line of road users at the junction can be maintained.	
S	Pedestrian traffic	Safety of pedestrian	Yes	Measures such as erection of hoarding and provision of alternative pedestrian routes will be provided during construction.	
S	Pedestrian traffic (cont'd)	Safety of pedestrian	Yes	A 2m wide public access will be provided for pedestrian movement at the north of Tsz Wan Shan Rest Garden. Adjacent schools will be well informed of site activities/ programme at each stage of traffic arrangement in order to keep students alert of the site activities	
EP	Construction noise	Construction noise nuisance to adjacent schools	No	The site is close to schools. The contract will specify that the contractor has to comply with the construction noise standards in the EIA Ordinance. The Contractor will need to plan his works, use suitable construction plant and provide necessary temporary noise mitigation measures to comply with the contractual and legal requirements.	
S	Maintenance of traffic	Construction works may affect traffic	Yes	Minipiles, which will only require little working space, have been adopted for use in the foundation. The foundations are located away from the carriageway. Sufficient working space will be provided to the contractor. No works will need to be carried out on the carriageway. It should be feasible to maintain traffic in the carriageway at most of the time.	
EP	Waste management	Temporary storage and transportation of construction wastes	No	Contractor is required to plan for temporary storage and transportation of construction wastes.	
B	Works area	Congested works site in urban area.	Yes	Agreement from LCSD and DLO has been obtained for providing sufficient working space at Tsz Wan Shan Rest Garden. A contractor's works area will also be provided at the southern side of Po Kong Village Road. The contractor should plan the loading/unloading points and storage areas to suit his methods of construction.	

Classification Code : Safety (S) ; Environmental Protection (EP) ; Buildability (B) and Maintainability (M)

## WORKED EXAMPLE NO. 5 - Appendix

### Impacts Summary

**Project Title : PWP Item No. 152TB - Footbridge across Po Kong Village Road at Junction with Tsz Wan Shan Road**

**Main Activity : To construct the pile foundation and substructure for the footbridge system**

Classification Code (See footnote below)	Key Word Development	Description of Impact	Impact Resolved Yes/No	If yes, please state the control measures	Endorsed by Design Reviewer Yes/No
EP	Tree preservation	Trees affected by the project	Yes	The trees which will need to be transplanted or retained have been agreed with LCSD. The contractor will be required to engage a specialist contractor to transplant the trees and protect the existing trees according to the requirements of LCSD.	
EP	Dust	Dust nuisance to pedestrian walking adjacent to the works site	Yes	Measures to mitigate dust problem will be adopted, e.g. dust suppression, water spraying, pave all site access, provision of wheel washing facilities, etc.	
EP	Wastewater	Generation of wastewater during excavation and piling works	Yes	Measures to mitigate wastewater problem will be used, e.g. provision of wheel washing facilities and sedimentation tanks. The contractor will need to apply for a licence from EPD to discharge wastewater to public drains in accordance with the Water Pollution Control Ordinance if necessary.	
B	Site logistics	Limited space for maneuvering of machinery plant and equipment	Yes	Mini-piles have been adopted in the foundation design in order to minimize the working space required. Agreement from LCSD and DLO has been obtained to provide sufficient working space to the Contractor.	
B	Foundation type	Pile foundations required at different locations.	Yes	Same type of pile foundation has been adopted for the whole project in order to achieve better buildability of the project.	

Classification Code : Safety (S) ; Environmental Protection (EP) ; Buildability (B) and Maintainability (M)

**Impacts Summary**

**Project Title : PWP Item No. 152TB - Footbridge across Po Kong Village Road at Junction with Tsz Wan Shan Road**

**Main Activity : To construct the columns, table-tops, main span and associated structures of the footbridge system**

Classification Code (See footnote below)	Key Word Development	Description of Impact	Impact Resolved Yes/No	If yes, please state the control measures	Endorsed by Design Reviewer Yes/No
S	Construction of bridge deck	Hazards during post-tensioning of tendons in the bridge deck	No	The post-tensioning will be carried out within the casting yard. Sufficient working space will be provided to the contractor for setting up the casting yard. The contractor is required to provide method statement together with risk assessment to ensure the safety of the workers and others.	
S	Construction of bridge deck over live traffic	Construction works may affect traffic underneath the proposed bridge deck.	Yes	Precast bridge deck has been specified for the bridge span over carriageway. Potential hazards of working at height and over existing live traffic have been minimized. The contract will specify that the erection of the precast bridge deck can only be carried out at night time in order to minimize disturbance to traffic.	
S	Construction of footbridge roof over live traffic	Hazards during roof construction	No	Contractor is required to provide method statement of erecting temporary working platform for the roof construction to ensure the safety of the workers and the roadusers underneath.	
S	Pre-fabrication	In-situ construction of staircases and lift housings.	No	For staircase and lift housings, the possibility of using pre-cast units would depend on the skill and resources of the contractor. The contractor is allowed under the contract to propose alternative design.	
S/M	Access for maintenance of planters	Hazards during future maintenance of soft landscaping works on edge planters in the bridge deck.	Yes	Safety measures in compliance with the safety standard such as 1000 mm high guardrail with a mid-rail 400 mm from top rail, 400 mm wide walkway and 200 mm high toe board have been provided to facilitate future maintenance of the edge planters on the bridge deck. Lockable parapets will be provided at the ends of both sides of the main span for access to the planters.	
M	Access for maintenance of roof	Hazards during maintenance of roof	Yes	Measures such as erection of working platform and the use of self-propelled hydraulic scaffold for painting and maintenance works will be adopted.	
M	Lifecycle consideration	Lifecycle cost	Yes	Roof cover is designed to be dome shaped to achieve the function of self-cleansing. Cladding will be provided to the roof posts to minimize future maintenance of the roof posts.	

Classification Code : Safety (S) ; Environmental Protection (EP) ; Buildability (B) and Maintainability (M)



CDM

*WORKED EXAMPLE No. 6*

*Escalators for Footbridge at LRT/Road  
Junction of Lung Mun Road and  
Tuen Tsing Lane*

Highways Department



## CONTENTS

---

<b>1. Project Information</b>	<b>143</b>
1.1 Scope of Works	
1.2 Project Location	
1.3 The Design Team	
<b>2. Site Environment and Nature of the Works</b>	<b>145</b>
2.1 Site Environment	
2.2 Nature of Work	
2.3 Liaison Activities	
<b>3. Identification of Special Hazards</b>	<b>147</b>
3.1 Improvement in Design under CDM	
3.2 Impacts Summary	
<b>4. Documentation</b>	<b>148</b>
4.1 Highlights	
4.2 Pre-tender Health and Safety Plan	
<b>5. Views</b>	<b>149</b>
5.1 Suggestions	
5.2 Comments	
 Appendix I - Pre-tender Health and Safety Plan	 150

## 1. Project Information

### 1.1 Scope of Works

The scope of the proposed Project comprises -

- (a) The erection of two escalators situated respectively:
  - adjacent to the northbound Light Rail Transit (LRT) platform at the "LRT Depot" stop, and
  - adjacent to the southbound LRT platform at the same stop and the adjoining footpath along Lung Mun Road;
- (b) The extension of the footbridge over the emergency LRT track across the western footpath of Lung Mun Road to connect a proposed escalator adjacent to the southbound LRT platform; and
- (c) Their associated road and drainage works.

At the time of the preparation of this "Worked Example", the status of the Project is categorized as "Cat B (under planning)". The Project is likely to be delayed due to funding arrangement.

### 1.2 Project Location

The project work area is situated at the junction of Lung Mun Road and Tuen Tsing Lane in Tuen Mun, New Territories. The location is shown in Figures 1a and 1b respectively.

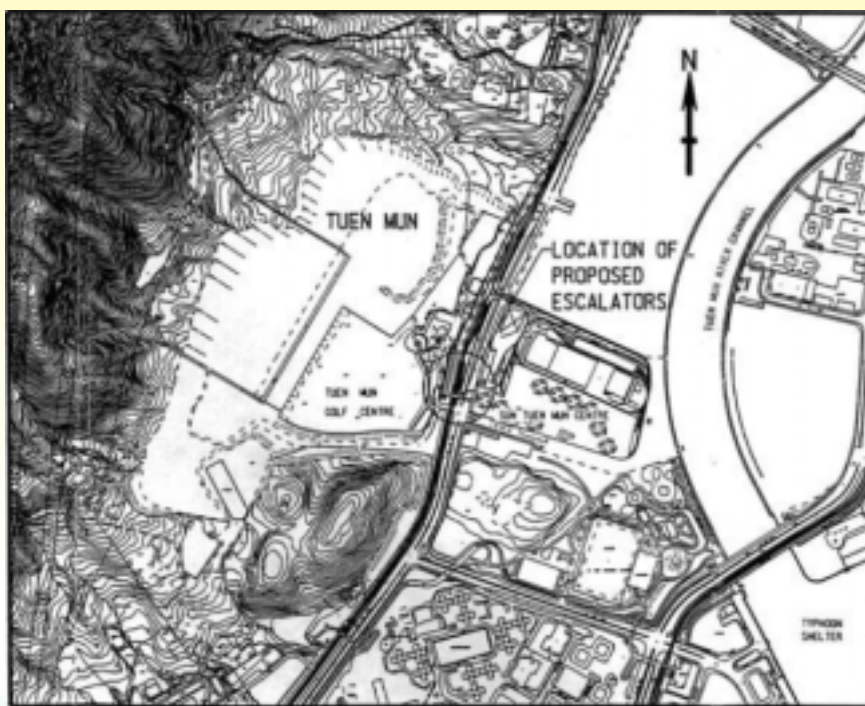

Figure 1a - Location Plan

## WORKED EXAMPLE NO. 6

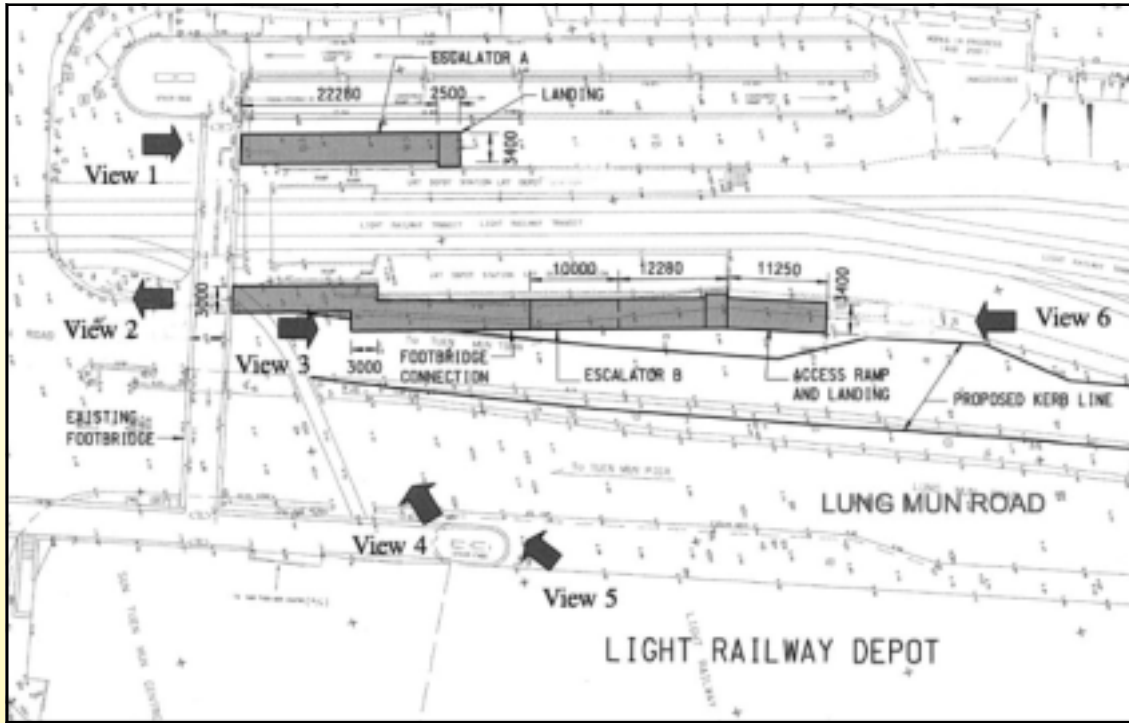
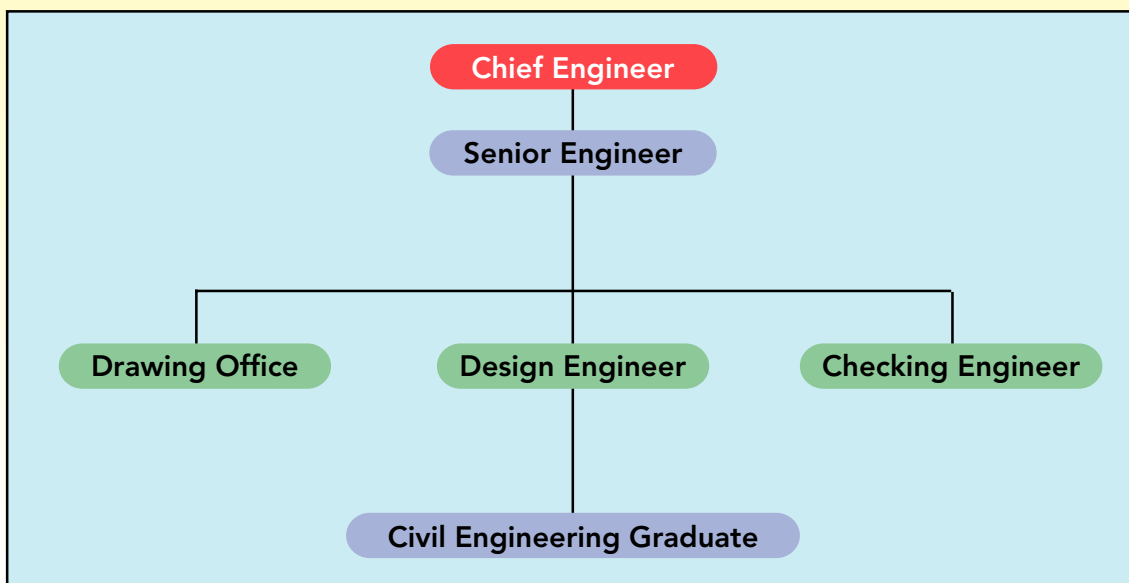

Figure 1b - Layout Plan

### 1.3 The Design Team

The organization structure of the design team is depicted as Table 1 as follows:

Table 1



## 2.1 Site Environment

The general site environment is well illustrated by the series of photographs in Figure 2 showing the different views around the site. Refer to Figure 1b for the directions.



View 1



View 2



View 3



View 4



View 5



View 6

Figure 2 - Views Around the Site

## 2.2 Nature of Work

The main construction activities envisaged, [with associated site constraints in boxes] are:

- (a) Implementation of temporary traffic and pedestrian diversion  
Works are adjacent to a heavy-traffic carriageway and footpath, and are close to LRT tracks and platforms.
- (b) Road and drainage works
- (c) Foundation works  
There is only limited working space along footpath for permanent works and plants during construction
- (d) Pre-fabrication of footbridge decks  
Availability of works area for prefabrication yard
- (e) Erection of footbridge decks  
Working over heavy-traffic carriageway, footpath and LRT emergency track; erection of bridge deck requires the closure of the carriageway at night
- (f) Construction of roofing and finishing works

## 2.3 Liaison Activities

The following stakeholders should be liaised with regard the project.

- (a) Highways Department NT Regional Office**
  - project management related issues
  - contact point for liaison with Transport Department, the client, regarding project scope and program of implementation.
- (b) EMSD**
  - interfacing issues regarding the E & M works for escalators as related to the escalator housing structures
- (c) Transport Department and Traffic Police**
  - temporary traffic arrangement and traffic related issues
- (d) KCRC**
  - interfacing design issues for works adjacent to LRT premises



(e) Management Office of the Sun Tuen Mun Centre (maintenance authority of existing footbridge)

- design issues regarding footbridge connection and demolition of existing parapet wall
- temporary occupation of the existing footbridge area for connection work

### 3. Identification of Special Hazards

#### 3.1 Improvement in Design under CDM

During a peer review, (*editor's note: peer review is not formally part of CDM, but the design team can always seek improvement to their design, by self criticism or peer review or whatever means convenient and if there is such opportunity*) queries were raised about the difficulty of maintenance of the footbridge roofing and the safety concern for the workers. The design team responded that future maintenance of the roofing as well as the deck could be carried out based on the current practices of using falsework, bamboo scaffolding or self-propelled hydraulic scaffold (see Figure 3a and 3b for reference. These pictures are taken from other projects).



Figure 3a



Figure 3b



Figure 3c

The peer review also provided useful advice to the design team about having safety anchorages or fall protection system installed on the roof. Examples of such system (from other projects) are illustrated in Figure 3c and 3d.

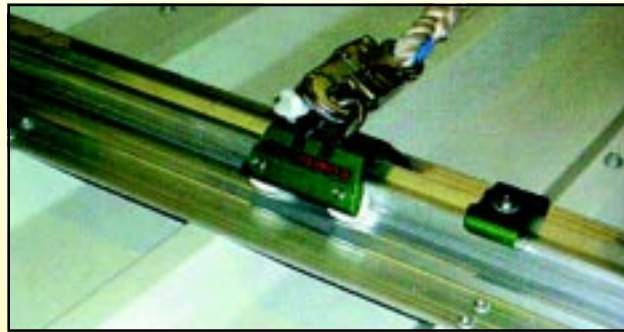

Figure 3d

### 3.2 Impacts Summary

The Impacts Summary is as Annex D to Appendix I (Pre-tender Health and Safety Plan)

## 4. Documentation

### 4.1 Highlights

The Pre-tender Health and Safety Plan contains information identified during the planning stage of the project on managing safety and health matters throughout the design and construction stage. It serves as handover notes to subsequent designers during the detailed design stage highlighting the main safety and health issues in connection with the construction work on the project. This will also form a basis for the preparation of the future Project Health and Safety Plan of the Contractor.

As the scope of the project involves mainly the construction of an elevated pedestrian walkway in a public area, the major areas of concern regarding health and safety hazards are:

- (a) working on, over or near busy traffic;
- (b) working in the vicinity of LRT tracks, overhead cables and wires;
- (c) working at height; and
- (d) nuisance such as noise, wastewater and dust, etc.

## **4.2 Pre-tender Health and Safety Plan**

A Pre-tender Health and Safety Plan is attached as Appendix I.

# **5. Views**

## **5.1 Suggestions**

The adequacy of relevant design and construction experience of the project officers is a key issue contributing to the success of the CDM process. The design team believes that the participants of the brainstorming sessions should be carefully selected, and include adequate experienced personnel, not necessarily restricted to those directly responsible for the project, to ensure fruitful results and enhance experience sharing. This is particularly important when the scope of the project is of such a nature calling for relevant experience for the identification of major issues such as buildability, safety and health hazards, maintainability and environmental concerns. Experienced architects/engineers outside the project team should be invited to attend the sessions where necessary.

## **5.2 Comments**

The implementation of the CDM process can provide an effective and systematic approach at the early stage of the project for the designers to minimize, if not eliminate, potential hazards and problems during construction and maintenance. It is hoped that the benefits of CDM can be fully appreciated during the actual implementation of the process.



# *APPENDIX I*

## **Pre-tender Health and Safety Plan**

## APPENDIX I - PRE-TENDER HEALTH AND SAFETY PLAN

### Escalators for Footbridge at LRT/Road Junction of Lung Mun Road and Tuen Mun Lane Pre-tender Health and Safety Plan

---

#### 1. INTRODUCTION

This pre-tender safety plan provides information identified during the planning stage of the Project on managing safety and health throughout the design and construction of a project. It serves as handover notes to subsequent designers (hereafter referred to as the Designer) during the detailed design stage highlighting the main safety and health issues in connection with the construction work on the project. This will also form a basis for the preparation of the future Pre-tender Health and Safety Plan enabling tendering contractors to respond more specifically on how to deal with and control any residual hazards and risks which cannot be eliminated in design stage.

#### 2. NATURE OF THE PROJECT

##### 2.1 Parties to the Project

Client : Transport Department of HKSAR  
Works Agency : Highways Department of HKSAR

##### 2.2 Location

###### 2.2.1 Site location and boundaries

The project area is situated at the junction of Lung Mun Road and Tuen Tsing Lane in Tuen Mun, New Territories. The location plan is shown in Appendix I.

###### 2.2.2 Proposed development

Provision of two escalators connecting the existing at-grade Light Rail Transit (LRT) platforms at Lung Mun Road and the existing footbridge linking Sun Tuen Mun Centre. The new escalators serve to encourage the public to use the existing footbridge rather than the at-grade crossing to gain access to and from the LRT platforms.

##### 2.3 Nature of the Work

The Project will involve the construction of two escalators with the housing structures, a footbridge extension and the associated road and drainage works.

##### 2.4 Programme of the Work

The original tentative construction period for the Project is from October 2004 to September 2006. The Project has been delayed and the programme is subject to review by the Project Office.

### **3. The Existing Environment**

#### **3.1 Surrounding Land Uses and Related Restrictions**

The proposed escalators and footbridge extension is situated at the two sides of the LRT platforms alongside the northbound Lung Mun Road near Tsuen Tsing Lane. The completed works will connect the platforms and the footpath with the existing footbridge system spanning across Lung Mun Road.

An LRT Reserve delineating the LRT premises from the public areas is located along the LRT tracks and platforms. No work will be allowed within the above zone without the consent of KCRC. An emergency LRT track crosses Lung Mun Road at the southern portion of the site leading to a LRT depot adjacent to the Sun Tuen Mun Centre.

#### **3.2 Existing Services**

The relevant utility companies and government offices have been consulted regarding the locations and details of the existing underground utility services in the vicinity of the proposed footbridge. As revealed from the utility records, all existing utility services are under the footpath and carriageway apart from the overhead LRT cables and anchorage wires located near the LRT platforms and the emergency track. An existing underground stormwater culvert also lies underneath the northbound Lung Mun Road which will affect the location of the foundation of the footbridge extension.

#### **3.3 Existing Traffic Systems and Restrictions**

Lung Mun Road is a dual-2 carriageway linking the southern Tuen Mun with the Tuen Mun New Town and Tuen Mun Highway. A traffic impact assessment (TIA) will be conducted to assess the impact of the proposed works on the existing traffic system during the detailed design stage.

#### **3.4 Ground Conditions**

Ground Investigation for the Project was carried out in mid 2002 under GEO Works Order No. GE/2001/14.21. In general, the existing ground conditions have no major impact on the feasibility and design of the Project.

### **4. EXISTING DRAWINGS AND INFORMATION**

Existing topographical surveys are available from the Project Office - New Territories Regional Office of Highways Department. The as-built drawings of the existing footbridge, LRT platform layout drawings, details of the LRT tracks, cables and structural gauge, utilities plans and the existing stormwater box culvert layout drawings are also available at the Structures Division of the Highways Department.

## 5. HAZARDS IDENTIFIED DURING PLANNING STAGE

### 5.1 Significant Hazards

This section is to list those hazards, design assumptions, or work sequences which may be a risk to construction and maintenance workers' safety and health, and which cannot be avoided or designed out. It may not be a comprehensive list of every hazard that may be present, but rather those hazards which are considered most important, or those information that the Designer should be made aware of.

A summary of General Design Considerations for general site activities and works to be carried out on site during construction, operation & maintenance is provided in Annex B.

### 5.2 Preliminary Design Principles

#### 5.2.1 Construction Method and Sequence for Superstructure Construction

Due to the presence of the LRT platforms and the limited working space on site, the main deck of the footbridge extension structure will be planned to be precast off site at ground level and will be subsequently lifted into position by cranes at nighttime. Hence, the potential hazard of working at height can be reduced and the disturbance to the public will be kept to a minimum. The escalator and the housing structure at the western side of the LRT platforms (escalator A on the sketch shown in Annex A) will be constructed in-situ as there is also no working space for the crane to operate due to the existing footbridge ramps. In addition, the precast units cannot be lifted across the LRT tracks.

Temporary and/or partial road closure will be required during lifting operations. The Contractor will be responsible for preparing submission of temporary traffic arrangements to Transport Department and the Hong Kong Police Force for comments if considered necessary.

For roof construction, the Contractor can choose either in-situ erection or pre-fabricated off-site and then install above the deck on site. If the former construction option is adopted, the Contractor should provide a safe working platform with adequate protective measures along both side of the structure.

#### 5.2.2 Substructure Construction

The Designer should be aware of the existing utility cables beneath ground, especially those would impose danger to workers (e.g. gas mains and high voltage cables). The Designer should identify the utility cables/mains in advanced and should take appropriate measures to protect the cables/mains as well as prevent the workers from those dangers.

Due to the limited working space on site, mini-piles are planned to be adopted for the foundation of the footbridge extension. As smaller drillings will be required, this can avoid the use of heavy-duty boring machines in congested areas. It can also minimize the generation of excessive noise which may cause nuisance to the nearby residential area in Sun Tuen Mun Centre.

The columns will be constructed in the form of an inverted L-shape (see Fig 1) in view of the narrow footpath adjacent to the LRT platforms and the insufficient carriageway width of Lung Mun Road on site to widen the footpath.

### 5.2.3 Environmental Protection

The Designer is required to liaise with Environmental Protection Department for the application of noise permit in order to minimize the noise impact to the nearby sensitive receivers such as residents, and the control of any sewage, wastewater or effluent to flow from the Site onto any adjoining land and carriageway, especially the wastewater generated from piling operation and wheels washing facilities.

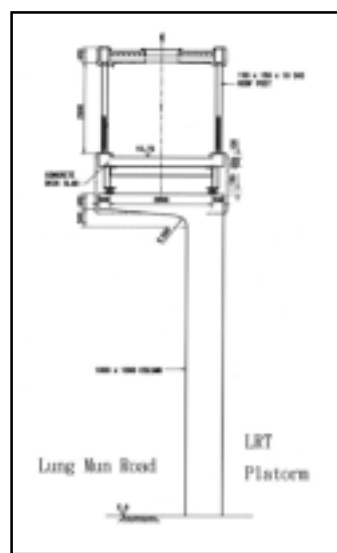

Fig 1

## 5.3 Specific Hazards / Residual Risks

The Designer is reminded to take appropriate measures to eliminate or reduce and control the risks created by the hazards detailed in the Project Specific Design Considerations and the Impacts Summary as attached in Annex C and Annex D respectively. These hazards will be stated here only to the extent necessary to enable the Designer to identify safety and health issues relating to key areas and to assess the risks, and to put in place methods to manage them.

The Designer is required to elaborate further and provide proposals to either eliminate or mitigate the residual risks which cannot be avoided or designed out including amongst others;

- (a) working on, over or near existing live traffic;
- (b) working in the vicinity of LRT tracks, overhead cables and wires;
- (c) working at height;
- (d) generation of nuisance such as noise, wastewater and dust, etc.

## 5.4 General Site Wide Hazards / Risks

### 5.4.1 Site Access and Egress Points

Site access and egress points should be discussed and agreed with Transport Department. The Designer shall consider temporary traffic arrangement for construction vehicles and develop a construction access strategy for the project.

5.4.1.1 Site access and egress points for Escalator B and Footbridge Extension  
Construction vehicles could gain access into the works area directly from the northbound Lung Mun Road.

5.4.1.2 Site access and egress points for Escalator A  
Construction vehicles could not gain access to this portion of site directly from Lung Mun Road due to the presence of the LRT platforms. Access in and out of the site could utilize the access road leading to the golf centre.

#### **5.4.2 Location of Temporary Site Accommodation and Works Areas**

DLO/TM shall be consulted to identify the appropriate location of temporary site accommodation and works areas for the Project.

#### **5.4.3 Traffic/Pedestrian Routes**

Temporary closure of the footpath along the eastern side of the LRT platforms will need to be closed off for construction of the substructures. The pedestrian can be diverted through the LRT platforms but such arrangement has to be agreed with KCRC. Alternatively, temporary crossing at Lung Mun Road can be utilized to divert the pedestrians. The feasibility of both measures will be discussed and agreed with the Transport Department and Traffic Police during a later stage of the Project.

## **6. CONTINUING LIAISON**

### **6.1 Procedures for Safety and Health Implications of Detailed Designs**

- (a) The Designer should consider details of the hazards, associated risk assessments and mitigation measures in the detailed design.
- (b) As the works is adjacent to the LRT Reserve, the Designer should maintain a close liaison with KCRC throughout construction to ensure safety of works in the vicinity of LRT Reserve. The safety guidelines and Particular Specifications issued by KCRC for works around LRT tracks should also be closely observed.
- (c) Details of any re-design found to be necessary, together with details of the hazards and risk assessments should be issued in ample time before execution of the work.

### **6.2 Pre-tender Health and Safety Plan**

During the detailed design phase, the Health and Safety Plan is the responsibility of the Contractor. Safety and health must be an agenda item in the site meetings. Pre-tender Health and Safety Plan shall also be prepared.

### **6.3 Safety and Health File**

The inputs to the Safety and Health File will be brought into a consolidated document and will be consistent with the Health and Safety Plan that describes the safety and health information available.

The Designer shall provide relevant information to the Health and Safety File during the progress of the work with the aim that there should be no outstanding information by completion of the construction of the property. Such information may be design criteria, selected "as built" drawings, general details of methods and materials used, details of any ongoing actions and requirements, and details of the location and nature of utilities and services.

The file will be added to during the construction stage.

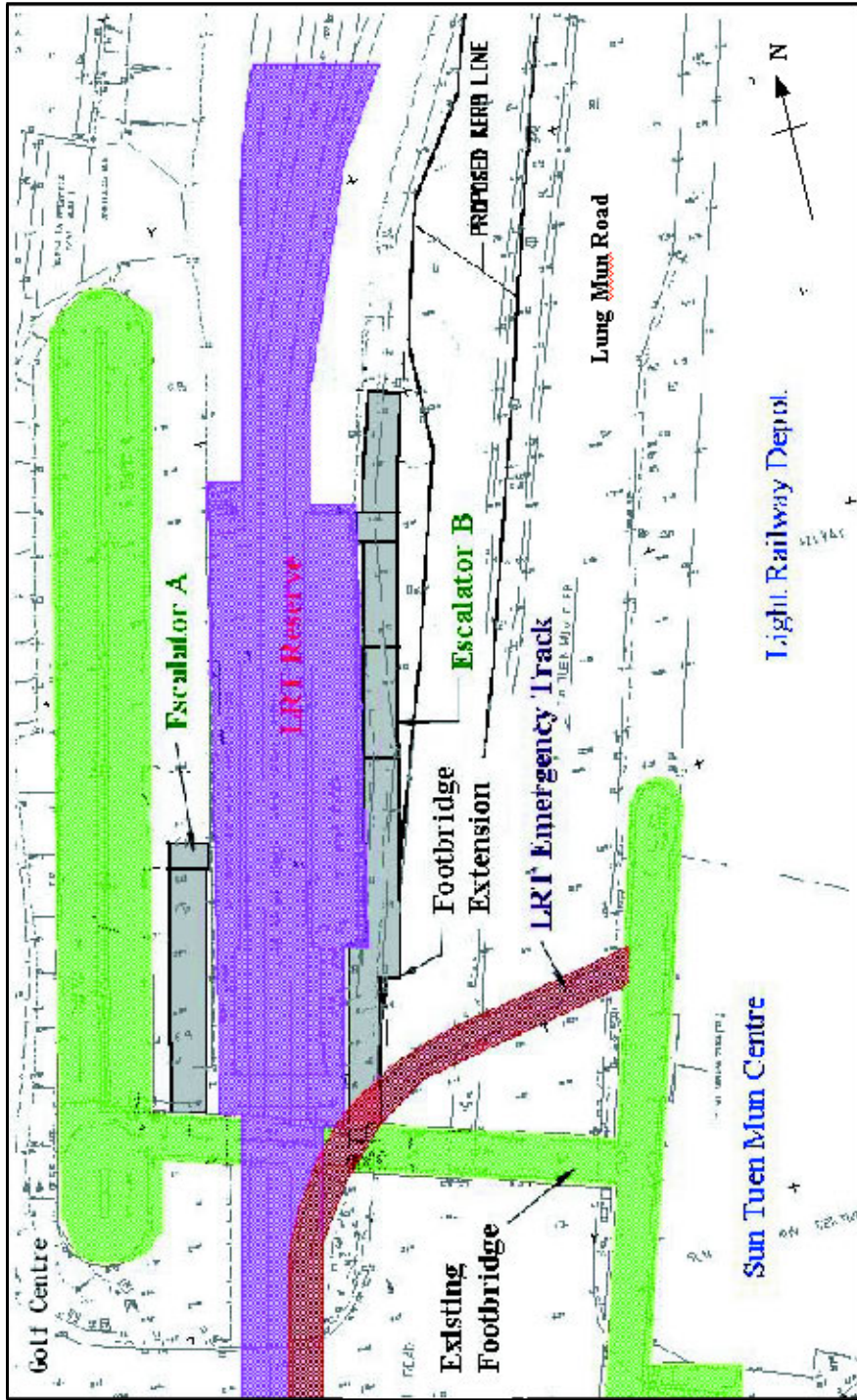

## ANNEX B - GENERAL DESIGN CONSIDERATIONS

### (A) General Site Activities

- (1) Site Logistics
  - (a) Storage, handling, use and disposal of materials, in particular waste management.
  - (b) Works area, site office and accommodation.
- (2) Public Safety & Impact
  - (a) Pedestrians.
  - (b) Road users.
  - (c) Public facilities, e.g. LRT platforms, bus stops, traffic signs and signals.
  - (d) Parking of construction vehicles.
- (3) Environmental Control
  - (a) Noise - noise sensitive receivers, e.g. residents, golf centre.
  - (b) Promotion of greening and preservation of trees.
- (4) Layout
  - (a) Provision for the disabled - escalators.
  - (b) Impact on pedestrians during maintenance of escalators.
  - (c) Convenience of connection to public facilities.
  - (d) Public promotion and customer satisfaction.

### (B) Construction

- (1) Site Formation
  - (a) Environmental protection - impact due to dust suppression, noise, etc.
  - (b) Safety - considerations on utilities, machine and equipment (e.g. bulldozer, truck, excavators, etc), human and vehicular access, excavated collapse and erosion.
- (2) Piling
  - (a) Environmental protection - impact due to dust suppression, noise, wastewater or muddy water.
  - (b) Safety - considerations on lifting operation, plant safety, etc.
- (3) Landing Structure
- (4) Span Construction

### (C) Operation and Maintenance

- (1) Consideration to Facilitate Community Provision and Dismantling
  - (a) Escalator.
  - (b) Cleaning, e.g. span, landing, roof, drains, etc.
  - (c) Lighting.
- (2) Consideration to Facilitate Structural Maintenance
  - (a) Bearings.
  - (b) Movement joints.



## ANNEX C - PROJECT SPECIFIC DESIGN CONSIDERATIONS

### ESCALATOR A

#### (A) General

- (1) Site logistics
  - (a) Congested Site - limited works area between existing footbridge ramps and LRT platform.
  - (b) Lack of site access.
- (2) Pedestrian / Public safety.
  - (a) Safety of pedestrian and LRT passengers.
  - (b) Provision of proper hoarding at the ramps section for the prevention of crime at night time.

#### (B) Construction

- (1) Site formation and piling works  
Insufficient space for maneuvering of machinery plant and equipment.
- (2) Superstructures  
Proper sufficient hoarding and fencing to prevent trespassers both at the footbridge main deck and the ramps.

### FOOTBRIDGE EXTENSION AND ESCALATOR B

#### (A) General

- (1) Traffic impact  
Closure of slow lane at Lung Mun Road for the construction of foundations and columns.
- (2) Effect of construction works on the operation of the emergency LRT track.
- (3) Safety impact  
Safety during roof construction and maintenance.
- (4) Pedestrian / Public safety.
  - (a) Safety of pedestrian and LRT passengers.
  - (b) Sufficient sight distance for vehicles during erection of hoarding.

#### (B) Construction

- (1) Superstructures
  - (a) Consideration of precast unit for the decks of the footbridge extension.
  - (b) Sufficient safety provisions for works at height above footpath and LRT platforms.
  - (c) Proper hoarding and fencing to prevent trespassers at the interface with the existing footbridge.

### ANNEX D - IMPACTS SUMMARY

#### Work Impacts Mapping Summary

**Project Title : PWP Item No. 6144 TB/B - Escalators for Footbridge at LRT/Road Junction of Lung Mun Road and Tuen Tsing Lane**

**Main Activity : General Site Activities**

Classification Code (See footnote below)	Key Word Development	Description of Impact	Impact Resolved Yes/No	If yes, please state the control measures	Endorsed by Design Reviewer Yes/No
S	Works area	Work close to LRT tracks and stop	No	Continuous discussion with KCRC during future design and construction stages. Particular attention should be given to the existence of overhead LRT wires and the emergency track to the LRT depot adjacent to the work site	
B	Works area	Work over and across an emergency track	Yes	Maximize the use of prefabricated units to minimize possible disturbance to the entrance of the LRT depot	
EP	Disturbance to public	Create nuisance to the public and railway operation	Yes	Erect hoarding and safety fence	
S	Traffic	Safety of road users	Yes	(i) Site hoarding should not block sight lines of drivers (ii) "Left-in left-out" restriction at site access should be adhered to during construction works (iii) Temporary traffic arrangement and pedestrian diversion should be carefully planned to allow the proper functioning of the bus stop at the northern side of the LRT platform	
B	Site logistic	Safety of pedestrian	Yes	(i) Erection of hoarding to separate the public from work site and provision of sufficient warning signs (ii) Provision of alternative routes with adequate clear direction signs in case of temporary closure/diversion of footpaths	

Classification Code : Safety (S) ; Environmental Protection (EP) ; Buildability (B) and Maintainability (M)

## WORKED EXAMPLE NO. 6 - Appendix

### Work Impacts Mapping Summary

**Project Title : PWP Item No. 6144 TB/B - Escalators for Footbridge at LRT/Road Junction of Lung Mun Road and Tuen Tsing Lane**

**Main Activity : To construct the pile foundation for the footbridge and escalators**

Classification Code (See footnote below)	Key Word Development	Description of Impact	Impact Resolved Yes/No	If yes, please state the control measures	Endorsed by Design Reviewer Yes/No
B	Site logistics	Insufficient space for permanent substructures and maneuvering of machinery plants and equipment during construction.	Yes	(i) Inverted L-shaped columns will be used in view of narrow footpath adjacent to LRT platform along Lung Mun Road. (ii) Mini-piles construction will be adopted.	
EP	Wastewater	Generation of wastewater during excavation and piling operation.	Yes	Provisions of effective wheel washing facilities and proper temporary drainage system.	
EP	Dust	Dust nuisance to pedestrian and passengers at the LRT platform.	Yes	Pave all site access and erection of higher hoarding.	
EP	Noise	Noise nuisance to sensitive receivers at the nearby residential areas and shopping centre.	No	Evaluation of noise impact is required.	

Classification Code : Safety (S) ; Environmental Protection (EP) ; Buildability (B) and Maintainability (M)

**Work Impacts Mapping Summary**

**Project Title** : PWP Item No. 6144 TB/B - Escalators for Footbridge at LRT/Road Junction of Lung Mun Road and Tuen Tsing Lane

**Main Activity** : To construct the columns, main deck, escalators, roofing and associated structures of the footbridge

Classification Code (See footnote below)	Key Word Development	Description of Impact	Impact Resolved Yes/No	If yes, please state the control measures	Endorsed by Design Reviewer Yes/No
S	Pre-fabrication	Consideration of prefabricated units for the main span.	Yes	(i) Use of precast units for the construction of main span to minimise the potential hazards of working at height and around LRT premises. (ii) Erection of the precast unit at night time to minimize interference to the existing traffic.	
B	Connection	Connection of prefabricated units at height after erection.	Yes	(i) Consideration to use bolt connection for better control of workmanship. (ii) On site welding over carriageway, footpath and LRT platform is avoided where possible for safety consideration.	
M	Lifecycle consideration	Consideration of lifecycle cost.	Yes	Cladding will be used to minimize hazard due to maintenance of protective coating on steel girders. A harmonic view with the existing Sun Tuen Mun Centre can also be achieved.	
S	Demolition	Demolition of edge parapet at the interface with the existing footbridge over Lung Mun Road	Yes	(i) Good programming of works to minimize nuisance and inconvenience to the public using the existing footbridge. (ii) Erect hoarding before the opening of the footbridge extension to prevent trespasses.	
S & M	Fall of persons	Hazards during routine maintenance of roof.	Yes	Installation of safety anchorages on footbridge roof for workers to attach the safety belt.	

Classification Code : Safety (S) ; Environmental Protection (EP) ; Buildability (B) and Maintainability (M)



CDM

*WORKED EXAMPLE No. 7*

*Water Supply to Tai Long,  
Lantau Island*

Water Supplies Department

## CONTENTS

---

<b>1. Project Information</b>	<b>165</b>
1.1 Scope of Works	
1.2 Project Location	
1.3 The Design Team	
<b>2. Site Environment and Nature of the Works</b>	<b>166</b>
2.1 Site Environment	
2.2 Liaison Activities	
<b>3. Identification of Special Hazards</b>	<b>169</b>
3.1 Improvement in Design under CDM	
3.2 Impacts Summary	
<b>4. Documentation</b>	<b>171</b>
4.1 Highlights	
4.2 Pre-tender Health and Safety Plan	
<b>5. Views</b>	<b>172</b>
Appendix I - Impacts Summary	173
Appendix II - Pre-tender Health and Safety Plan	179

## 1. Project Information

### 1.1 Scope of Works

This is a village supply project. It comprises the construction of a fresh water pump house, a fresh water tank, and the laying of about 4 km of fresh water main from Chi Ma Wan Road (芝麻灣道) at Cheung Sha Wan (長沙灣) to Sea Ranch (澄碧邨) via Tai Long (大浪), Lantau Island.

### 1.2 Project Location

Figure 1 illustrates the respective locations.



Figure 1 - Chi Ma Wan Peninsula, Lantau Island

### 1.3 The Design Team

The design team comprises a senior engineer / design and an engineer / design from Water Supplies Department (WSD).



## 2. Site Environment and Nature of the Works

### 2.1 Site Environment

#### Site A - Tai Long Fresh Water Pump House

Site A is a permanent land allocation on Chi Ma Wan Road at Cheung Sha Wan, Lantau Island. Figure 2 below shows the location of the site, its existing condition and the appearance of the proposed pump house after completion.

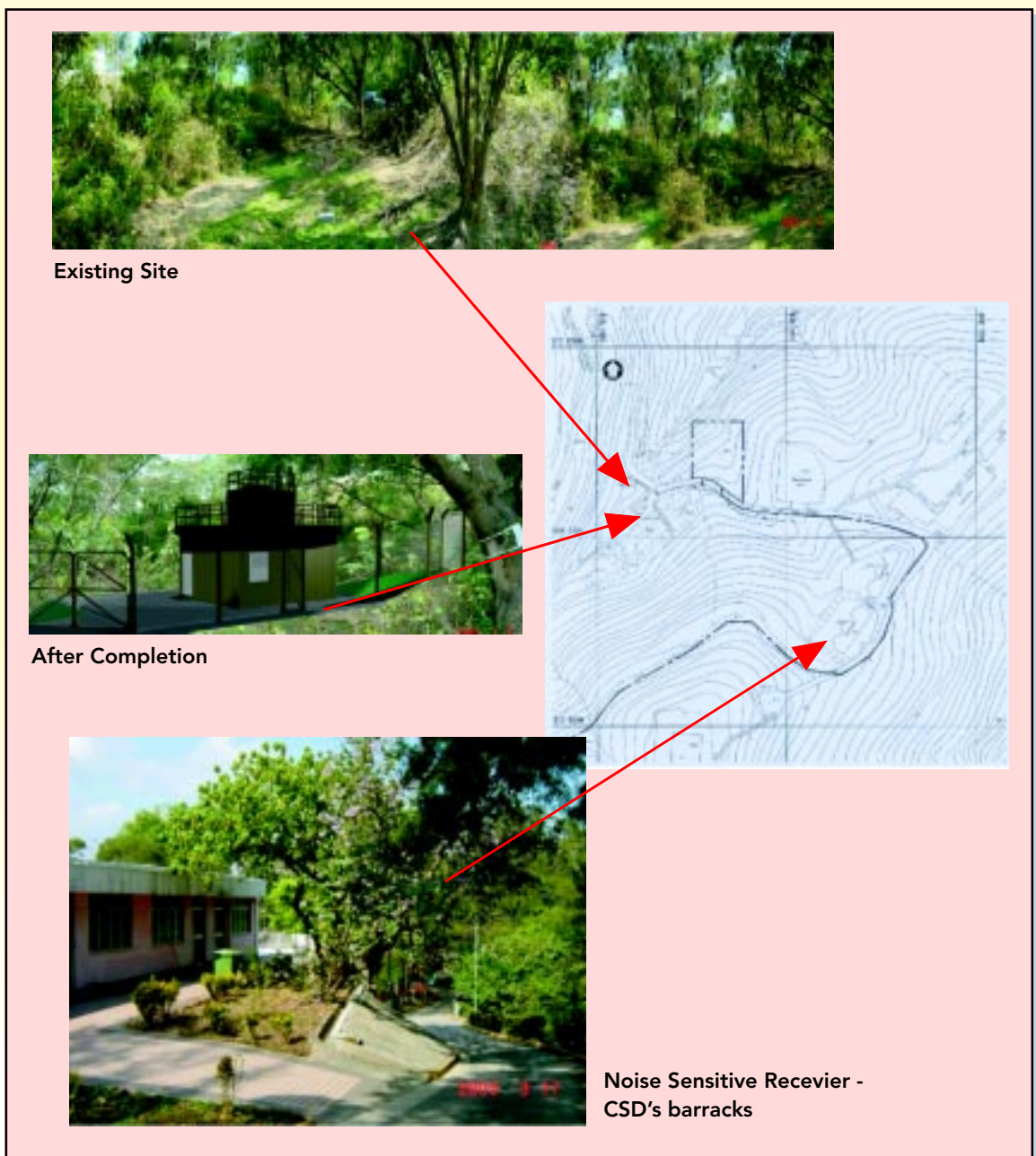

Figure 2 - Location of Site A Tai Long Fresh Water Pump House

Site A is within the Chi Ma Wan Correctional Institution (CMWCI) and close to the barracks, which are the nearest noise sensitive receivers (NSRs). In addition, some trees are also found within the boundary of the proposed Site A that may obstruct the construction of the pump house. When designing the general arrangement of the pump house, the NSRs and tree factors have been taken into account. The following are the principal concerns and special hazards:

1. Noise nuisance to NSRs;
2. Harmful effect of noise to working staff;
3. Tree preservation by minimizing the number of trees being cut; and
4. Construction works involving working at height.

#### **Site B - Tai Long Fresh Water Tank**

Site B is a permanent land allocation at Lung Mei (龍尾), Lantau Island within the Lantau South Country Park, which is inaccessible to land transport, causing difficulties to construction and materials transportation.

Selection of material for the water tank has been a crucial factor affecting its buildability. A good choice of material for the water tank can definitely facilitate the works. This design consideration is under Section 3.

#### **Site C - Laying of the Water Main**

The alignment of the proposed water main follows generally the existing road or trail from Chi Ma Wan Road to Sea Ranch via Tai Long, Lantau Island. The alignment is cross-country. Some sections of the trail are narrow. Construction materials cannot be transported to the site by land transport but must be hand carried. Choice of pipe material is restricted by this constraint. Communication amongst workers is important to safeguarding their safety in these remote areas. The general site condition is shown in Figure 3.

The alignment of the proposed water main also runs through Tai Long Wan archaeological site. Potential impact on archaeological resources is a concern that must be minimized. Section 3 will also cover how these considerations are to be dealt with.

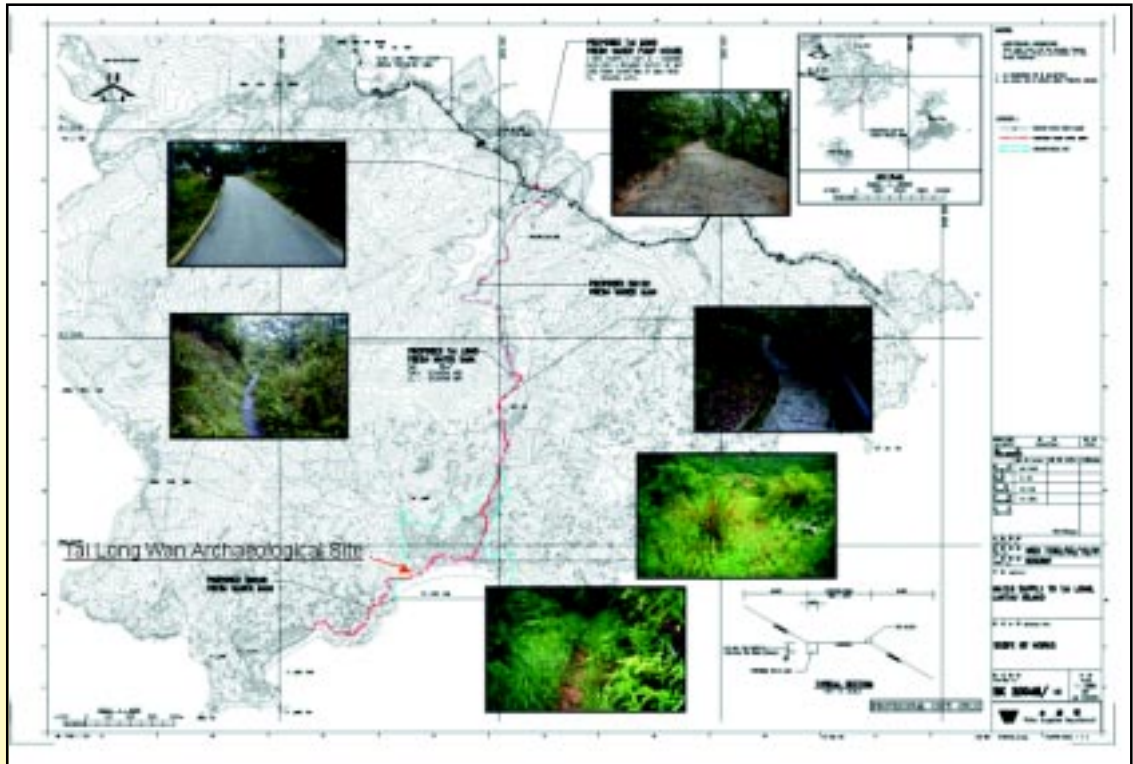

Figure 3 - Overview of Project Site Conditions

## 2.2 Liaison Activities

### Correctional Services Department

Site A is located in the vicinity of CMWCI. As the use of a helicopter to transport construction materials is considered, it is necessary to liaise with Correctional Services Department about the conditions of using their premises for the works and restrictions, and the allocation of an open area as a loading and unloading point.

### Country and Marine Park Authority (CMPA)

Liaison with Agriculture, Fisheries and Conservation Department is required to obtain approval from CMPA to carry out the proposed works in Lantau South Country Park.

### Antiquities and Monuments Office (AMO)

Liaison with AMO of Leisure and Cultural Services Department is required for carrying out the main laying works within the Tai Long Wan Archaeological Site. AMO will offer their professional comments on the preservation of archaeological resources and lay down the requirements and conditions for carrying out the works.







Figure 5 - GRP Tank with Brick Walls at Perimeter as Fire-break

### Pipe Laying within Tai Long Wan Archaeological Site

The project requires laying about 4 km water mains. When the pipe is laid through the Tai Long Wan Archaeological Site, care must be taken to avoid damaging the archaeological resources. Archaeological survey has been conducted in the detailed design stage, and some antiquities were found in the survey. AMO advised that the alignment of the pipe should be modified to avoid damaging the antiquities. AMO also advised that if an alternative alignment were not possible, archaeological rescue works would be necessary prior to laying the pipe. As the objective is to minimize any impact to the environment, the invaluable advice from AMO should be taken, and the pipe should run above ground within the Tai Long Wan Archaeological Site. This can avert substantial trench excavation, which may cause damages to the archaeological resources. Excavation for pipe support cannot be avoided, but rescue works can be greatly reduced, and the damage to the resources can be kept to minimum.

But to build the pipe above-ground in the archaeological site does affect the choice of pipe materials in the design. Originally, it is proposed to use polyethylene (PE) pipe throughout the whole alignment. PE pipe has advantage that it can be easily handled by labourers due to its lightweight. It is particularly suitable for cross country mainlaying works. PE pipe can be joined by electrofusion making the water main continuous (see Figure 6). This joining method eliminates the possible leaks from the joints and reduces the size and number of bend blocks. Nevertheless, PE pipe has a drawback that it is not durable when exposed direct sunlight. Therefore, DI pipe should be selected for above-ground laying (see Figure 7). Ductile Iron (DI) pipe is heavier than PE and therefore is relatively more difficult to handle, but a balance has to be struck between the ease of construction and environmental protection.



Figure 6 : Buried PE pipe along the most of the proposed alignment and Electrofusion Control Unit



Figure 7 : Exposed D.I. Pipes within Tai Long Wan Archaeological Site

### 3.2 Impacts Summary

The Impacts Summary is as Appendix I .

## 4. Documentation

### 4.1 Highlights

In the CDM process, it is necessary to prepare a Pre-tender Health and Safety Plan for the Tenderer to appreciate the considerations by the designer such that the identified issues, such as safety and health hazards and environmental nuisances, can be controlled and avoided during the execution of the works.

Based on the Impacts Summary developed during the CDM process, tables detailing the impacts or hazards, design considerations have been prepared as part of the Special Conditions of Tender to draw the Tenderer's attention. The Tenderers are required to address the concerned issues in their submitted tenders.

Remoteness and lack of access are the main characteristics of this project. Therefore, attention has been paid to the transportation of materials and the selection of construction materials.

### 4.2 Pre-tender Health and Safety Plan

A Pre-tender Health and Safety Plan is attached as Appendix II.

## 5. Views

Village water supply project aims at developing and installing a typical water supply system. It normally consists of the construction of a pump house, a water tank and water mains laying. The locations of works sites are largely remote and inaccessible. It is necessary in the design stage to consider factors such as the transportation of construction materials, mitigation of environmental impacts, safety and provisions for future maintenance. The solutions to cope with these design considerations have long been practised, but not in a systematic way. The implementation of CDM provides a structured means to consider and analyze those factors that may have great impact on the proposed works. Under the CDM process, through brain-storming and analyzing the factors in terms of buildability, environmental protection, safety and maintainability, the potential problems can be identified in the planning and design stages. Appropriate measures can then be taken to tackle these problems so that the project can be delivered smoothly and successfully.

Although different projects have different problems and characteristics, there are some common features in any class of projects. To save the resources and efforts in the process of CDM, it may be better to build a database, using information technology, for each class of projects so that some common hazards or issues can easily be dealt with by referring to the precedent cases. Only special hazards need to be considered specifically for particular scenarios, but once resolved, these new cases would become precedents for future projects, by updating the database. With this ongoing case development, the efforts put on CDM can be minimal and the quality of the project delivery maintains at a high level.

# *APPENDIX I*

## **Impacts Summary**



**APPENDIX I - IMPACTS SUMMARY**

**Project Title : Water Supply to Tai Long, Lantau Island**

**Main Activity : General Hazards**

Classification Code (See footnote below)	Key Word Development	Description of Impact	Impact Resolved Yes/No	If yes, please state the control measures	Endorsed by Design Reviewer Yes/No
EP	Hygiene	There is lack of toilet facilities in the vicinity of the Works.	Yes	Temporary toilet facilities will be provided for the use of workers. Where appropriate, septic tank and soak away pit will also be provided for the discharge from toilet.	Yes
EP	Disposal of Packing Materials	Due to remoteness of the site, disposal of packing materials will be a problem.	Yes	The packing materials will be gathered together for batch disposal by helicopter or by land transport if applicable.	Yes
EP	Drinking Water	There is shortage of water supply to the workers for drinking purpose.	Yes	Contractors will be requested to supply portable water to the workers.	Yes
S	Electrical Safety	There is potential electric shock when using the portable generator.	Yes	Earthing system will be provided for the portable generator to prevent the operator from electric shock.	Yes
S	Falling from height	There is potential falling for working at height during construction.	Yes	Provision of safe working platform to protect the workers from falling.	Yes

Classification Code : Safety (S) ; Environmental Protection (EP) ; Buildability (B) and Maintainability (M)

**Work Impacts Mapping Summary**

Project Title : Water Supply to Tai Long, Lantau Island

Main Activity : To construct a fresh water pump house next to Chi Ma Wan Road

Classification Code (See footnote below)	Key Word Development	Description of Impact	Impact Resolved Yes/No	If yes, please state the control measures	Endorsed by Design Reviewer Yes/No
B		Nil			
EP	Noise	Noise nuisance - The residents in the barracks in the vicinity of the proposed pump house may be affected during construction and operation stages.	Yes	The barracks are about 100m away from the site and sparsely occupied. Hoardings will be erected to reduce the construction noise to an acceptable level.	Yes
				Acoustic louvre will be positioned away from the receiver to reduce the noise level to less than 50 db during operation.	Yes
EP	Visual Impact	Tree felling - some existing trees obstruct the construction of the proposed pump house and platform are needed to be removed.	Yes	Compensatory plant and landscape design are proposed to mitigate the visual impact. The final approved proposal by relevant authorities will be strictly followed.	Yes
S	Pedestrian Safety	Pedestrian safety - People may gain access to the construction site.	Yes	Erection of hoarding to prevent the people from entering the construction site.	Yes
S	Falling from height	Working at height is a potential risk during the pump house construction.	Yes	Provision of safe working platform to protect the workers from falling.	Yes
M	Ear Protection	The noise generated by the operating pumps may be harmful to the maintenance staff entering and staying in the pump house.	Yes	Warning signs will be displayed in prominent position to remind the maintenance staff to wear ear protective equipments when carrying out routine inspection and repair inside the pump house.	Yes
M	Falling from height	There is a risk of falling from height when carrying out maintenance works on the roof.	Yes	Parapet walls will be constructed to reachable area and anchorage points for safety belt will also be provided.	Yes

Classification Code : Safety (S) ; Environmental Protection (EP) ; Buildability (B) and Maintainability (M)

## WORKED EXAMPLE NO. 7 - Appendix

### Work Impacts Mapping Summary

**Project Title : Water Supply to Tai Long, Lantau Island**

**Main Activity : To construct a fresh water tank at Lung Mei**

Classification Code (See footnote below)	Key Word Development	Description of Impact	Impact Resolved Yes/No	If yes, please state the control measures	Endorsed by Design Reviewer Yes/No
B	Site Inaccessibility	Site remoteness - The site is inaccessible and construction materials such as GRP or other suitable materials for the pre-fabrication of water tank cannot be transported by normal transport means.	Yes	The mechanical and electrical plants, and construction materials will be transported in batch by helicopter to suit the works programme.	Yes
B	Site Formation	Site formation - Due to the remoteness of site, it is difficult to transport and use heavy plant for construction.	Yes	Site formation works will be kept to a minimum and light-weight construction plants will be used to for the works.	Yes
		Concreting Works - Longer time is required for in-situ casting of the water tank and transportation of construction materials, such as aggregates, formworks etc is difficult.	Yes	GRP or other suitable materials will be used for pre-fabricated water tank. Bricks will be used to construct the perimeter wall as fire protection covers to minimize the use of in-situ concrete.	Yes
B / EP	Concreting Works	Noise Nuisance - noise will be generated by the helicopter during concreting works and cause nuisance to the country park visitors.	Yes	Time restriction can be imposed for the concreting works from 9:00 a.m. to 5:00 p.m. daily excluding Sundays & public holidays.	Yes
B	Test on Completion	Water Test - Inavailability of water for testing the water tank.	Yes	The proposed Tai Long pump house can be programed for early completion so as to provide water for testing the water tank.	Yes
EP	Visual Impact	Tree felling - some existing trees obstruct the construction of the proposed water tank and platform.	Yes	Compensatory plant and landscape design have been proposed to mitigate the visual impact. The final approved proposal by relevant authorities will be strictly followed.	Yes
EP	C&D Waste	C&D Waste Disposal - It is difficult to dispose the C&D waste due to the site remoteness.	Yes	The excavated materials will be fully used on site for landscaping works so as to minimize the disposal quantities.	Yes
S	Emission of irritant gases	During fabrication of GRP tank, there is a possibility of emission of irritant gases from the volatile solvents, and other hazardous materials, hot asphalt and bitumen.	Yes	The Contractor will be reminded about this potential hazard and required to propose precautionary measures.	Yes
S	Country Park Visitor Safety	Country Park Visitor Safety - People may gain access to the construction site.	Yes	Erection of hoarding to prevent the people from entering the construction site.	Yes
S	Falling from height	Workers may fall from height during the water tank excavation and construction.	Yes	Provision of safe working platform and fencing to protect the workers from falling.	Yes
S	Concreting Works	Concreting Works by Helicopter - There is potential hazard by using helicopter for concreting operation.	Yes	Provision of special safety training course for concreting labourers.	Yes
M	Water tank cleaning	The completed water tanks become confined spaces.	Yes	Procedures and requirements for 'Working in confined spaces' have to be followed.	Yes

Classification Code : Safety (S) ; Environmental Protection (EP) ; Buildability (B) and Maintainability (M)

**Work Impacts Mapping Summary****Project Title : Water Supply to Tai Long, Lantau Island****Main Activity : To lay water mains within the Lantau South Country Park and Tai Long Wan archaeological site**

Classification Code (See footnote below)	Key Word Development	Description of Impact	Impact Resolved Yes/No	If yes, please state the control measures	Endorsed by Design Reviewer Yes/No
B	Site Inaccessibility	Inaccessibility of land transport - The proposed water mains will follow the existing narrow trail/footpath. Pipe and construction materials cannot be transported to site by trucks. Manual handling is required.	Yes	Pipe materials will be delivered as close to the site as possible by land and marine transport e.g. small truck or boat to minimise manual handling. The Contractor is required to take means not to allow the labourers to carry excessive weight.	Yes
				Where applicable, the existing condition of the trails should be improved to facilitate the transportation of construction materials by hand tools. Bricks will be used for the construction of valve pits and pipe supports instead of in-situ concrete.	Yes
B	Pipe Materials	Selection of Pipe Materials - Ductile Iron (D.I.) pipe is suitable for exposed pipe. However, for buried pipe, it will need to provide leakage collection system to collect the possible leak which may affect the stability of existing slopes. Due to the remoteness of the site, it will be more difficult to transport materials for leakage collection system construction.	Yes	Where possible, polyethylene (PE) pipe will be used for buried pipe. As PE pipes are jointed by electrofusion, it will become a continuous string. No leakage collection system is required and this reduces the quantity of construction materials.  The use of PE pipe can reduce the risk for manual handling of heavy weight as it is lighter than D.I. Pipe.	Yes
B / S	Trench Works	The pipe trench may be flooded in rainy days.	Yes	The pipe trench will be backfilled immediately after pipelaying to avoid flooding of trench.	Yes

Classification Code : Safety (S) ; Environmental Protection (EP) ; Buildability (B) and Maintainability (M)

## WORKED EXAMPLE NO. 7 - Appendix

### Work Impacts Mapping Summary

**Project Title** : Water Supply to Tai Long, Lantau Island

**Main Activity** : To lay water mains within the Lantau South Country Park and Tai Long Wan archaeological site

Classification Code (See footnote below)	Key Word Development	Description of Impact	Impact Resolved Yes/No	If yes, please state the control measures	Endorsed by Design Reviewer Yes/No
		Country park visitors may fall into trench accidentally.	Yes	The open trench will be covered by plastic covers at night or when unattended. Moreover, the length of the open trench will be restricted to minimize such risk.	
EP	Visual Impact	The exposed pipes may give a visual impact to the country park visitor .	Yes	The water pipe will be laid underground as far as possible to mitigate the visual impact and to minimize the construction of pipe supports. However, for the section within the Tai Long Wan archaeological site, the water pipe will be exposed to minimize the excavation and hence less damage to the archaeological resources.	Yes
S	Falling to the downward slope	Some sections of the existing footpath are narrow and their width is less than 1.5m. Visitors may fall to the slope carelessly.	Yes	Toe block or steel bar will be used to draw the visitors' attention to potential danger.	Yes
S	Insect or snake bite	There are insect or snake in the remote area. Workers may be bite by them.	Yes	Contractor's attention will be drawn to the possible insect and snake bite.	Yes
S	Loss contact in remote area	The alignment of the water mains is cross country. If a worker is injured, it may not be possible to call for help in this remote condition.	Yes	To highlight to the Contractor on communication measures e.g. use of walkie talkie to keep contact with other colleagues.	Yes
M		Nil			

Classification Code : S: Safety ; EP: Environmental Protection ; B: Buildability and M: Maintainability

## *APPENDIX II*

### **Pre-tender Health and Safety Plan**

## APPENDIX II - PRE-TENDER HEALTH AND SAFETY PLAN

### Water Supply to Tai Long, Lantau Island

#### Pre-tender Health and Safety Plan

---

#### CONDITIONS OF TENDER

##### Outline Safety Plan

- (a) The tenderer shall submit with his Tender an Outline Safety Plan which shall be the tenderer's proposals to ensure safety and health in the execution of the Works.
  - (b) The Outline Safety Plan shall start with a formal statement of policy on safety and health and shall include:
    - (1) identification of safety and health hazards which may be encountered in the execution of Works;
    - (2) an outline of proposed safety and health measures for the control and prevention of such safety and health hazards; and
    - (3) the manner by which safety and health measures will be implemented and monitored.
  - (c) The Outline Safety Plan shall be used for the purpose of tender assessment and shall not form part of the Contract.
  - (d) Attached at Appendix B to these Special Conditions of Tender is the Pre-tender Health and Safety Plan prepared by the Project Design Team. The Pre-tender Health and Safety Plan will not form part of the Contract and is provided for information only to assist in the preparation of the Outline Safety Plan.
- 

#### Appendix II to Special Conditions of Tender

##### Pre-tender Health and Safety Plan

(This Pre-tender Health and Safety Plan will not form part of the Contract and is provided for information only to assist in the preparation of the Outline Safety Plan)

#### 1. GENERAL

##### 1.1 Document

This document merely serves as a guideline to the tenderers, for the preparation of the Outline Safety Plan.

The health and safety consideration outlined herein had been included comprehensively in various parts of the tender document. This document is therefore regards as a summary of the health and safety items, for which the tenderers would have been taken into account.

### **1.2 Start of "Construction Phase"**

The Contractor should not commence the construction phase until he has adapted and developed his Safety Plan as stated in section 12 of this document. The Safety Plan should be submitted to the Engineer or his representative in sufficient time for their consideration.

### **1.3 Programme**

In preparing the detailed programme, the Contractor should allow for the adoption of safe working procedures and co-ordinate and rationalize activities to avoid uncontrollable hazards arising due to the clashes of activities.

### **1.4 Sub-Contractors, Suppliers & Designers**

The Contractor should ensure that all direct appointments in connection with this project include provisions for the compliance of his sub-contractors, suppliers and designers, etc, with the relevant provision of the Particular Specification for Site Safety in the Contract.

### **1.5 Liaison**

The Contractor should liaise with the Engineer or his representatives as required under the requirements of the Particular Specification for Site Safety and in connection with the preparation of the Safety Plan.

## **2. PROJECT DESCRIPTION**

### **2.1 Site Addresses**

The proposed sites for pump house and fresh water tank will be located at Cheung Sha Wan and Lung Mei, Lantau respectively.

### **2.2 Description of Work**

This project comprises the construction of a fresh water pump house, a fresh water tank and the laying of about 4 km of fresh water mains from Chi Ma Wan Road at Cheung Sha Wan to Sea Ranch via Tai Long, Lantau.

### **2.3 Estimated Duration of Construction Phase**

As stated in the Form of Tender.



### 3. INFORMATION REQUIREMENT

The tenderers should provide the following information in the Outline Safety Plan.

#### 3.1 General

- A copy of his corporate Health & Safety Policy Document.
- An Outline Safety Plan to be submitted with the tender.

#### 3.2 Management

- Details of the personnel and systems to be put in place to prepare, manage, implement and monitor the Safety Plan for the project.
- Details of relevant qualifications and experience held by the persons nominated above, including recent health and safety education and training undertaken.
- Procedures for determining the competence of contractors engaged on the project, whether employed by the contractor directly or by others, to fulfil their duties under the Contract.

#### 3.3 Programme

- The Contractor should develop the Safety Plan within the first week after the commencement date, in order to ensure the set up of the site for the works to be carried out properly.

### 4. SITE CONDITIONS

#### 4.1 Site Location

Site 1, 2 and 3 are defined as follows:

##### 4.1.1 Site 1 - Fresh Water Pump House

The proposed Tai Long Fresh Water Pump House will be located next to Chi Ma Wan Road at Cheung Sha Wan, Lantau. The site is within Chi Ma Wan Correctional Institution. It is in close proximity of the barracks of the Correctional Services Department.

##### 4.1.2 Site 2 - Fresh Water Tank

The proposed Tai Long Fresh Water Tank will be located at Lung Mei, Lantau. The site is within the Lantau South Country Park. It is close to the existing trail which is commonly used by the local villagers and the country park visitors.

##### 4.1.3 Site 3 - Alignment from Chi Ma Wan Road to Sea Ranch via Tai Long

The alignment of the proposed water mains will mainly follow the existing trail and Chi Ma Wan Road. Some sections of the trail are narrow. A section of the alignment will pass through the Tai Long Wan archaeological site. It is necessary to pay particular attention to avoid the possible damage to the archaeological resources within the site.

#### **4.2 Existing Traffic System and Restriction**

The proposed Tai Long Fresh Water Pump House site is generally accessible by land transport. Since Chi Ma Wan Road is a single lane road with width about 3.5m only, the road is not suitable for the heavy goods vehicle.

The proposed site for Tai Long Fresh Water Tank is not accessible by land transport because the existing footpath/trail is narrow. The construction materials can only be transported to site manually or by helicopter. An open area within the Chi Ma Wan Correctional Institution can be used as a loading and unloading point for the helicopter to transport the construction materials to site, but prior permission must be obtained from the Correctional Services Department (CSD). Contractor and sub-contractors are required to liaise with CSD for using the open area.

The existing footpath/trail is narrow. The pipe materials in general cannot be transported by vehicles. They can only be delivered to site manually. The use of marine transport to deliver the pipe materials to Tai Long Wan can shorten the pipe delivery distance, but the possible damage to the archaeological resources must be cautious.

Since the works will be carried out within the Chi Ma Wan Correctional Institution and Lantau South Country Park, the Contractor or sub-contractors are required to liaise with CSD and Agricultural, Fisheries and Conservation Department respectively and strictly comply with the conditions as laid down by the departments.

#### **4.3 Existing Services**

Live services may be present beneath the sites and will need to be detected, maintained or diverted during works. The Contractor and other contractors involved in the works should exercise appropriate caution and adopt good measures to survey the underground services before carrying out any work. A safe system of work should be developed by relevant contractor in control of the utilities work prior to starting on site.

Prior to the commencement of works the Public Utilities will need to be contacted individually in order to determine the locations of their services.

#### **4.4 Existing Ground Conditions**

Ground investigations were carried out on the proposed fresh water tank and pump house sites. Trial pits were also dug to locate the existing utilities. The record of drill holes and trial pits are available for inspection. The Contractor is, however, required to excavate some more trial pits to identify the ground conditions in order to obtain sufficient information for the proposed works.

#### **4.5 Adjacent Projects**

The Contractor and other contractors involved in the works should liaise and coordinate with any other parties carrying out works in the vicinity and with any others likely to be affected by the work on site. This may include local residents and other construction projects.

The Contractor should develop a suitable system to enable those who may be affected by relevant works to be informed in good time before the works start, so that they can make appropriate arrangement as necessary.

## **5. EXISTING DRAWINGS AND INFORMATION**

### **5.1 Existing Drawings**

A selection of existing drawings of the site is available for inspection at the Water Supplies Department.

### **5.2 Information Available for Inspection**

The Water Supplies Department will keep and make available for inspection information regarding the type and location of utilities at the office, and the information are only for reference purpose.

## **6. THE DESIGN**

### **6.1 Principal Hazards Identified by the Project Team**

This section is to list those hazardous operations / hazards, design assumptions, of work sequences which may be a risk to construction workers' health and safety, and which cannot be avoided. It may not be a comprehensive list of every hazard that may be present, but rather those hazards that the designers consider the most important, and the information that contractors may not be reasonably expected to know. The list does not include commonplace site hazards which are deemed to be familiar to the average competent contractor and can be controlled by normal good site management practices.

The Hazards Summary containing the unresolved hazards to be addressed by the Contractor is given in the Annex A.

### **6.2 Contractor's Proposals**

The Contractor should take appropriate measures to eliminate or reduce and control the risks created by the hazards detailed below, in the Hazards Summary Sheets and throughout this document. Explanation of the proposed measures is to be included in the form of detailed method statements. Any other particular hazards in addition to those above are to be identified by the Contractor, who is to submit proposal as to how their associated risks may be controlled.

## **7. SITE WIDE ELEMENTS**

### **7.1 Site Access and Egress**

Site 1 & 2

- The Contractor should develop a Construction Access Strategy for the project.
- Materials and plant shall be stored away from means of access for the general public and local residents.
- Rubbish and demolition materials shall be removed regularly. Accumulation is not allowed on site.

Site 3

- Excavated materials shall not be stockpiled on site.
- Free access should be maintained at all times to allow the passage of general public.

### **7.2 Deliveries**

The Contractor is to make proposal of the delivery strategy of the construction materials.

### **7.3 Emergencies**

Most of the works will be carried out within the country park and rural areas. The Contractor is to make proposal for the communication of his employees, Water Supplies Department's site staff and other sub-contractors working in the areas e.g. provision of walkie-talkie.

### **7.4 Location of Temporary Site Accommodation**

The Contractor is to make proposals for the provision and location of temporary site accommodation for his employees, Water Supplies Department's site staff and other sub-contractors for the duration of the works in accordance with relevant clauses in Particular Specification.

Temporary site accommodation is to be located in a position so as not to interfere with access to and from the site nor access to and from the Works. Formal confirmation of the Engineer or his representatives are required prior to the commencement of works.

The fire and emergency access must be maintained at all times.

### **7.5 Location of Unloading, Layout and Storage Areas**

The Contractor is to plan and co-ordinate the provision of unloading, layout and storage areas, to suit the methods of construction and work in progress, subject to the approval of the Engineer or his representatives.

Materials are to be unloaded and stored in locations which will not in any way affect access or egress to the site nor the works. The setting up of hoarding shall take into accounts of this area.

### **7.6 Traffic and Pedestrian Routes**

The road, public footpaths are to be kept open at all times. All necessary signage and barriers are to be put in place to protect pedestrians at the site entrance and access and egress points. The Contractor should provide adequate separation between the works area and the public access.

### **7.7 Special Consideration to Welfare Facilities**

The Contractors should be fully conversant with the tender documents and will be required to develop proposals to respond to the health and safety requirements in this section.

Provision of site welfare facilities to be in accordance with the requirements set out in Bill No. 1 - Preliminaries and the Particular Specification for Safety.

### **7.8 Environment**

#### **Noise:**

Due to the sensitivity of the neighbourhood, the Contractor should provide provisions against noise and vibration by controlling it at source by fitting silencers and dampers where possible. Do not keep machinery running unnecessarily.

#### **Pollution:**

Take precautions to protect against pollution of water courses and the air. Damp down the ground to ensure that dust is not generated. Ensure that during the site formation all dust is kept to a minimum by damping down at regular intervals.

Provide personal protective equipment including head protection, ear protectors for all operatives involved in noisy operation, eye and face protection, respiratory protective equipment, general and specialist clothing, gloves, safety footwear.

#### **Waste Disposal:**

Refer to Particular Specification for the disposal of the toxic waste.

### **7.9 Security**

- Ensure that all ladders and other means of access to scaffolding are removed at the end of each working day and locked in a secure area.
- Maintain a daily log of all site operatives and visitors to record time of arrival to site and departure from site.
- Issue all operatives with suitable identification badges to be worn and displayed at all times whilst on site.
- Lock away in secure storage flammable or dangerous substances.
- Immobilize plant at the end of each work period.

### **7.10 Safety**

- Ensure that all employees are aware of the safety policy and put into place arrangements to ensure that all visitors and workers new to the site are aware of the site safety provisions.
- Portable electric tools and equipment are to be supplied from 110V transformers or have special measures taken to protect them from mechanical damage and wet conditions.
- Locate underground electricity cables, mark and take precautions to avoid.
- Ensure that cartridge operated tools are operated by trained personnel and in accordance with the makers' instructions that the gun is cleaned regularly and kept in a secure place when not in use.
- Ensure that there are chutes for waste to avoid materials being thrown down.
- Ensure waste material is removed regularly and that the site is kept tidy and materials stored safely.
- Ensure that all personnel can reach their place of work safely.
- Provide adequate artificial lighting when work is carried out after dark or inside building.
- Ensure that ladders are in good condition and that they are secured either at the top or bottom to prevent slipping. The ladders are to rise by at least 1.07m above their landing place.
- Provide adequate scaffolding to carry out the works ensuring that there is proper access, all uprights provided with base plates, it is secured to the building, fully board working platforms, provide adequate guard rails and toe boards to every side which a person can fall more than 1.98m, that where loaded with materials, they are evenly distributed, where the scaffold is near the boundary then debris netting should be incorporated, the scaffold is inspected on a weekly basis and after bad weather and that the results of the inspection are recorded and signed by the person who carried out the inspection.
- Provide the right number and type of fire extinguishers in positions where they may be needed. Ensure all fire extinguishers are properly maintained and inspected and a record of inspection certified on the appliance.

## **8. OVERLAP WITH CLIENT'S UNDERTAKING**

### **8.1 Works at High Level**

- Provide temporary protection to areas below to prevent injury from falling materials.

## 9. TEMPORARY WORKS

### 9.1 Scaffolding and Working Platform

- The erection of scaffolding and working platforms to all elevations of the proposed fresh water tank and pump house is envisaged.

### 9.2 Access Generally

- Provide safe access for operatives in the form of ladders/stairs/hoists on the working platform, etc.
- Provide temporary barrier rails to all open roof edges and large openings of floor.
- Provide safe access for the pedestrians and workers on site in form of temporary trench cover, lighting, barrier and signage.

## 10. SITE RULES

### 10.1 Permit to Work Requirements

On commencement of the works the Contractor will assume total responsibility for the site.

The Contractor is responsible for consulting statutory authorities as required by the various Regulations and standards with regards to contamination. The Contractor should co-ordinate risk assessments related to the works and establish rules and procedures for health and safety issues arising. The site rules should include reference to the following issues:

- Institute a "hot work" permit system in respect of metalwork flame cutting, site welding, asphalt repairs and the like.
- Control working in confined spaces
- Control of persons gaining access to the site
- Briefing of persons gaining access to and working on the site
- Prohibition of Smoking and Alcohol
- Personal hygiene and protective clothing
- Radio and audio equipment
- Emergency procedures
- Site induction procedures with specific reference to Fire & Emergencies, Vehicles on Site and Use of Harnesses

The arrangements will be controlled and monitored by the Contractor to meet changing needs of the site personnel as appropriate to the site operations.

## **10.2 Injury**

- Maintain proper first aid facilities administered by qualified personnel.
- Make arrangements for all contractors to report accidents, ill health and dangerous occurrences notifiable to the Environment, Transport and Works Bureau.

## **11. METHOD STATEMENTS**

### **11.1 Scaffolding**

The following are to be considered before implementation of the associated works:

- Provide general arrangement drawing for scaffolding to all elevations detailing bridging and protection over means of ingress and egress, and the like; protective works to public roads and footways; hoist arrangement.
- Disposal of rubbish and demolition materials from site.

### **11.2 Hoarding**

Method Statements should be submitted for any proposals for the erection or proposed changes to the layout and design of scaffoldings and hoardings.

## **12. CONTINUING LIAISON**

### **12.1 Procedures for the Health and Safety Implications of Contractors' Designs**

The procedures for consideration and evaluation of the health and safety implications of contractor designed elements of the works must follow the recognized principles of prevention and protection and take account of the issues highlighted in this outline of the Health and Safety Plan. The Contractor is to provide details of the hazards, and associated risk assessments to the Project Team before execution of the work.

Hazards arising from the use of temporary works to be identified and risk assessed by the Contractor in advance of the execution of the work.

Suitable and sufficient information to demonstrate that health or safety issues have been adequately considered.

#### **Risk assessments**

A list of health and/or safety hazards identified which cannot be designed out.

A list of any materials or substances which are specified or inherent in the design which are potentially hazardous to health and safety.



### **12.2 Procedures for Dealing with Design Changes**

Details of any re-design found to be necessary, together with details of the hazards and risk assessments should be issued in ample time before execution of the work. The Contractor is requested to submit the assessment to the Engineer or his representatives for approval and the subsequent incorporation into the Safety Plan.

### **12.3 Unforeseen Eventualities**

The following action is to be taken in the event of unforeseen eventualities arising during the construction stage of the project which require significant design changes, or affect the resources required to carry out the work without risk to health and/or safety, or have other health or safety implications.

The Engineer or his representatives and, where possible, the Contractor are to be advised as soon as possible.

Full details of the relevant health and safety issues involved are to be reviewed with the Safety Officer and the Contractor as soon as possible.

Full details of any revised designs, and risk assessments and identified hazards and/or hazardous materials and substances are to be issued to the Safety Officer and the Contractor in sufficient time to allow for the revision of the Health and Safety Plan and notification of all persons affected by the health and/or safety implications of the changes prior to the commencement of the affected works.

### **12.4 Safety Plan**

Modify the Safety Plan to reflect variations in design or changes in site conditions and liaise with the Safety Officer.

The Contractor should develop this Pre-tender Health and Safety Plan so that it:

- a. Incorporates the Contractor's approach to managing the construction work to ensure the health and safety of all persons carrying out the construction work and all persons who may be affected by their work.
- b. Includes the risk assessments prepared by all Contractors.
- c. Includes the arrangements for ensuring that, where appropriate or specifically requested, all Contractors / Sub-Contractors prepare suitable and sufficient method statements for their construction works which incorporate adequate measures for ensuring the health and safety of all persons who may be affected by these works.
- d. Incorporates the common arrangements for site welfare, statutory notices and registers, etc.
- e. Includes the site rules to be adopted for controlling the risks to health and safety during the construction phase(s) or the project.
- f. Includes reasonable arrangements for monitoring compliance with health and safety legislation and site rules.

- g. Includes reasonable measures to ensure co-operation between all Contractors and Sub-Contractors in respect of health and safety provisions and prohibitions.
- h. Includes the steps to be taken to ensure that only authorized persons are allowed into any parts of the site / premises where construction works is being carried out.
- i. Includes arrangements for emergency procedures as required under the Health and Safety Regulations and the arrangements for displaying notices relating to these procedures.
- j. Includes arrangements for ensuring that, so far as is reasonably practicable, every Contractor and Sub-Contractor is provided with comprehensible information about the risks to health and safety of that Contractor / Sub-Contractor, or of any employees or other persons under the control, arising out of the construction works, including the emergency procedures.
- k. Includes details of the arrangements for ensuring, so far as is reasonably practicable, that the employees or other persons under the control of any Contractor / Sub-Contractor, and visitors to the site, receive adequate information about the risks to their health and safety arising out of the construction works and, where necessary, adequate training to carry out their work in a safe and healthy manner.
- l. Includes arrangements for providing all persons at work on the site and visitors to the site with the opportunity and means of discussing and offering advice on health and safety issues relating to the construction works.
- m. Includes arrangements for the reporting of any accidents, injuries or dangerous occurrences.
- n. Can be modified as the work proceeds to take into account of any information received from Contractor / Sub-Contractors, any experience gained during the course of the project or any changes necessary as a result of unforeseen circumstances or alterations to the design.

### **12.5 Site Liaison**

Liaison with all other contractors and implement any agreed changes to the Safety Plan arising from such liaison. Set up regular training for all operatives including induction training for all staff upon arrival to site.

### **12.6 Health and Safety File**

Provide the Project Team with any relevant information which the contractor believes should be incorporated into the Health and Safety File.

### **12.7 Design Development**

Provide the Project Team with all design information prepared by sub-contractors; arranging liaison meetings with sub-contractors to discuss and review health and safety issues arising from the sub-contractors' designs.

### Annex A - Hazards Summary

#### Water Supply to Tai Long, Lantau Island

#### Summary of Unresolved Hazards

SITE	HAZARD / WORK IMPACT	DESIGN CONSIDERATIONS	CONTRACTOR'S ATTENTION	NOTES
<b>Site 1 - Tai Long Fresh Water Pump House</b>	<p>Noise nuisance - The residents in the barracks in the vicinity of the proposed pump house may be affected during the construction and operation stages.</p> <p>Visual Impact - Some existing trees obstruct the construction of the proposed pump house and platform are needed to be removed.</p> <p>Pedestrian Safety - People may gain access to the construction site</p> <p>Falling from height - Working at height is a potential risk during the pump house construction</p> <p>Falling from height - There is a risk of falling from height when carrying out maintenance works on the roof.</p> <p>Ear Protection - The noise generated by the operating pumps may be harmful to the maintenance staff entering and staying in the pump house</p>	<p>Specify the requirements to minimize the noise level</p> <p>Provide compensatory trees and propose landscape design to mitigate the visual impact.</p> <p>Specify the requirement to prevent the people gain access to the construction site.</p> <p>Require the Contractor to provide adequate measures to reduce the risk.</p> <p>Construct or provide some facilities to minimize the risk of falling from height.</p> <p>Draw the maintenance staff's attention to potential risk and remind them to wear ear protective equipments.</p>	<p>Erect hoardings to reduce the construction noise to an acceptable level.</p> <p>Follow strictly the final approved proposal by relevant authorities.</p> <p>Design and erect hoardings to prevent people from entering the construction site.</p> <p>Provide safe working platform to protect the workers from falling.</p> <p>Construct parapet walls to reachable area.</p> <p>Provide anchorage points for safety belt.</p> <p>Provide warning signs in prominent position to remind the maintenance staff to wear ear protective equipments when carrying out routine inspection and repair inside the pump house.</p>	<p>To address in the hoarding plan.</p> <p>To address in the Safety Plan.</p>
<b>Site 2 - Tai Long Fresh Water Tank</b>	<p>Site Remoteness - The site is inaccessible and construction materials such as GRP or other suitable materials for the pre-fabrication of water tank cannot be transported by normal transport means.</p> <p>Site formation - Due to the remoteness of site, it is difficult to transport and use heavy plant for construction.</p> <p>Water Test - Inavailability of water for testing the water tank.</p> <p>Visual Impact - Some existing trees obstruct the construction of the proposed water tank and platform are needed to be removed.</p>	<p>Explore other means to transport the construction materials.</p> <p>Specify the requirement to use light-weight construction plants</p> <p>Minimize the scale of site formation works.</p> <p>Specify the requirement to complete the pump house first so as to provide water for testing the tank.</p> <p>Provide compensatory trees and propose landscape design to mitigate the visual impact.</p>	<p>One way to transport the mechanical and electrical plant, and construction materials is by helicopter in batch.</p> <p>Use light-weight construction plants for the works.</p> <p>Program the proposed Tai Long Fresh Water Pump House for early completion so as to provide water for testing the water tank</p> <p>Follow strictly the final approved proposal by relevant authorities.</p>	<p>To reflect work sequences in the master programme.</p> <p>To address in the Safety Plan.</p> <p>To address in the hoarding plan.</p> <p>To address in the Safety Plan.</p>

SITE	HAZARD / WORK IMPACT	DESIGN CONSIDERATIONS	CONTRACTOR'S ATTENTION	NOTES
	<p>Emission of Irritant Gases - During fabrication of GRP tank, there is a possibility of emission of irritant gases from the volatile solvents, and other hazardous materials, hot asphalt and bitumen.</p> <p>Country Park Visitor Safety - People may gain access to the construction site.</p> <p>Falling from height - Workers may fall from height during the water tank excavation and construction.</p> <p>Water tank cleaning - The completed water tanks become confined spaces.</p>	<p>Require the Contractor to propose precautionary measures to minimize this potential hazard.</p> <p>Specify the requirement to prevent the people gain access to the construction site.</p> <p>Require the Contractor to provide adequate measures to reduce the risk.</p> <p>Specify the procedures for working in confined space.</p>	<p>Propose precautionary measures to minimize the potential hazard.</p> <p>Design and erect hoarding to prevent the people from entering the construction site.</p> <p>Provide safe working platform and fencing to protect the workers from falling.</p> <p>Follow strictly the procedures and requirements for "Working in confined spaces".</p>	
<p><b>Site 3 - Alignment of Water Main</b></p>	<p>Inaccessibility of land transport - The proposed water mains will follow the existing narrow trail/footpath. Pipe and construction materials cannot be transported to site by trucks. Manual handling is required.</p> <p>Trench Works - The pipe trench may be flooded in rainy days.</p> <p>Trench Works - Country park visitors may fall into open trench accidentally.</p> <p>Falling to the downward slope - Some sections of the existing footpath are narrow and their width is less than 1.5m. Visitors may fall to the slope carelessly.</p> <p>Insect or snake bite - There are insect or snake in the remote areas. Workers may be bite by them</p> <p>Loss contact in remote area - The alignment of the water mains is cross country. If worker is injured, it may not be possible to call for help in this remote condition.</p>	<p>Suggest possible ways to deliver pipe and construction materials.</p> <p>Suggest other construction material to facilitate their transport e.g. light-weight materials.</p> <p>Specify the requirement to backfill the open pipe trench immediately.</p> <p>Specify the requirement to cover the trench at night or when unattended and to restrict the length of open trench.</p> <p>Suggest possible means to alert visitors the possible danger.</p> <p>Remind the Contractor the possible insect or snake bite in remote areas.</p> <p>Highlight and require the Contractor to devise a communication scheme to reduce this risk.</p>	<p>May deliver pipe materials to site as close as possible by land and marine transport.</p> <p>Not to allow the labourers to carry excessive weight.</p> <p>May use bricks to construct the valve pits and pipe supports instead of in-situ concrete.</p> <p>Backfill the open pipe trench immediately after pipelaying to avoid flooding of trench.</p> <p>Cover the open trench by plastic covers at night or when unattended.</p> <p>Restrict the length of the open trench to minimize the risk.</p> <p>Use toe block or steel bar to draw the visitors' attention to potential danger.</p> <p>There is possible insect or snake bite in remote areas.</p> <p>Devise a communication scheme to keep contact with other colleagues e.g. use of walkie-talkie.</p>	<p>To address in the Safety Plan.</p> <p>To address in the Safety Plan.</p> <p>To address in the Safety Plan.</p> <p>To address in the Safety Plan.</p> <p>To address in the Safety Plan.</p> <p>To address in the Safety Plan.</p>



CDM

*WORKED EXAMPLE No. 8*

*Design Stage of a Proposed Public  
Housing Development Project*

Housing Department

## CONTENTS

---

### **1. Project Information 197**

- 1.1 Preamble
- 1.2 Project Location
- 1.3 Planning Studies

### **2. Project Team and Design Development 198**

- 2.1 The Project Team
- 2.2 Design Development and Workshops

### **3. Site Environment and Nature of the Works 199**

- 3.1 Site Environment
- 3.2 Nature of the Works

### **4. Design Consideration 200**

- 4.1 Foundation
- 4.2 Superstructure
- 4.3 Precast Elements
- 4.4 Drainage
- 4.5 Finishes
- 4.6 Design Details for Easy Operation and Maintenance

### **5. Way Forward 203**

- 5.1 Practicable Features of CDM
- 5.2 Design Guidelines and Design Meetings

## 1. Project Information

### 1.1 Preamble

In 2001/2002, the Housing Department was actively looking into the possibility of applying the concept of CDM to selected construction works projects for housing development. Having made an attempt to try it out on a pilot project at the design stage, the Housing Department then explores means of applying practicable features of CDM further. Although the project did not proceed to tender stage, the experience gained from the pilot project provides useful reference for future application.

### 1.2 Project Location

The 2.5 hectares site is located on the southern side of Pok Hong Estate and Sha Tin Wai New Village. It is bounded by Sha Tin Road to the north and Sugar Loaf Peak to the east, south and the west. Shui Chuen Au Street serves as the main vehicular access.



### 1.3 Planning Studies

Thorough understanding of the site at the early inception stage provides a sound basis from which design for safety and health develops.



Conducting environment assessment and traffic impact study, for instance, identifies hazards which can be addressed at early design. Source of noise affecting the site are identified. These include noises generated from existing and developed traffic flow, aircraft and industrial operation. Source of pollution, such as emission from vehicles, is another potential hazard identified. How these hazards affect the development are taken into account in the planning and formulation of development parameters at the inception and feasibility stage of the project. For instance, windows are designed at zones least exposed to hazards and pollution sources. Noise barriers are designed only as a measure to overcome residual noise hazards. Understanding the patterns of pollutants dispersion enables buildings to be designed avoiding undesirable exposure. Design of carpark ventilation also reflects these data, e.g. by natural airflow or mechanized ventilation, corresponding to pollutant source and meteorological data. Traffic assessment enables development parameters to be drawn up with safe transportation design for both vehicular and pedestrian traffic.

Adopting these CDM design principles avoid the need for resolving environmental hazards at later design stages. This fundamentally resolves issues at source and at the earliest stage.

## 2. Project Team and Design Development

### 2.1 The Project Team

- The Housing Authority is the client developing this public housing project. As its executive arm, the Housing Department formed a Project Management Team overseeing the project.
- The Design Team comprises the Architectural Consultant and Sub-consultants, including Structural, Building Services, Quantity Surveying, Civil, Geotechnical and Environmental.
- Although no contractor was involved in any tender process, selected prominent Housing Authority listed contractors on the Premier League were invited to participate in workshops discussion during the design development stage.
- The Estate Management and Maintenance Division of the Department actively contributed their earliest comments to the Project Management Team and Design Team at design stage for incorporation, in the form of feed forward partnering.
- Notwithstanding the absence of a Planning Supervisor appointed for the project, safety aspects were evaluated, among other initiatives, in workshops. Since the project did not proceed to the tender stage, documentation of a pre-tender safety plan and onward health and safety file could not be illustrated in this worked example.

## 2.2 Design Development and Workshops

Throughout the design development stage, workshops were led by the Project Management Team and attended by the Design Team (Consultants), the Estate Management Team and invited prominent Contractors. These workshops discussed a wide range of related issues such as buildability, sustainability, manageability, maintainability, life-cycle costing, durability, innovative features, alternative designs, etc. embracing the CDM concept, although CDM was not exclusively discussed.

After evaluating feedback, the findings and results were recorded and action plans were established.

Relevant to CDM, the key to designing for safe construction is based on the following work sequence:

- Identify the hazards
- Eliminate the hazards
- Reduce the risk
- Control residual risk
- Record and inform all parties who attend to this control

This process should be applied to all stages of design development from Concept, Scheme, Detailed Design, Construction and Post-completion.

However, readers should note that the specific circumstance particular to this project and the subsequent abortion of further progress beyond tender stage would not render this project adequate for full CDM illustration. Nevertheless, this project illustrates the prospect that decisions made at design stage can significantly reduce or even avoid risks altogether instead of managing risks at later stages.

## 3. Site Environment and Nature of the Works

### 3.1 Site Environment

The site sits on hillside surrounded by slopes on all sides, comprises two platforms at levels 89mPD and 106mPD. Rock is generally found at shallow depth beneath a thin surface fill layer and in-situ decomposed soil. Shallow pad and raft foundation on rock would generally be feasible with some deep foundation to suit local conditions.

### 3.2 Nature of the Works

The project was aimed to be a public housing project calling for innovative theme enhancing the identity of the development. The Development was designed to provide some 2,500 housing flats for a population of 8,000 persons. Among key objectives, the development aimed to incorporate modular design concepts enabling mechanized construction. The development also aimed for a readily buildable scheme and establishing a sustainable environment.

## 4. Design Consideration

Below are a sample of features, which design process had considered Safety, Buildability and Maintenance. These should not be read as a comprehensive design checklist but some key points that had been highlighted for experience sharing.

### 4.1 Foundation

#### Foundation design

The foundation system generally comprises shallow pad and raft foundation on rock with some deep foundation to suit local conditions. One prominent design consideration is to ensure stability of the sloping site, e.g. by stepped down rafts and avoids transfer of loading which might trigger slope failures during and after construction.

### 4.2 Superstructure

#### (1) Structural design

By linking the towers, a stronger structure is achieved. Structural elements with movement joints requiring maintenance at height are reduced as a result. How to construct the link is reviewed, aiming for minimum and optimum requirement for special concrete pour for the linked towers when crane aid is absent. Working at height during construction is reduced.

#### (2) Concrete specification

Specification and controlling concrete micro-cracking to within 0.3 mm wide tolerance avoids the need for repair involving working at height after construction completion.

### 4.3 Precast Elements

**(1) Precast units**

Among the key objectives, the development aimed to incorporate modular design concepts enabling mechanized construction. Prefabricated elements include facades, semi-precast slabs, staircase and beams. This construction approach in general reduces intensive on-site works which harbours potential risk to injury.

**(2) Bay window unit**

The whole unit is prefabricated off-site and enables easier installation without intensive working at height.

**(3) Walkway unit**

All members are precast off-site, thus enabling easier installation without intensive working at height.

**(4) Balcony upstands**

Prefabricated aluminium panel upstands and posts enable easier installation without intensive working at height. Risk of fall of persons and falling objects are reduced. Ease of cleaning reduces cleaners working at height. Maintenance guide of assembly items is provided for proper safety maintenance during occupation use. Sample mock up set up before actual construction enables evaluation of their effectiveness.

**(5) Facade protection**

The facade is protected from concrete spillage by cover during construction. There is also a work plan for immediate hosing of water during construction. These provisions reduce cleansing at height afterwards.

**(6) Large floor panel formwork**

Formwork panel is designed to enable large size construction within crane safe operation capacity. Risk is reduced by less number of lifting operations.

### 4.4 Drainage

**(1) Drain stack near balcony**

Access is provided from balcony for inspection/ maintenance of drainage eye. This facilitates maintenance with reduced risks of falling from height and falling objects.

### (2) AC condensation

Pipes are provided for collecting AC condensation. These pipes are exposed for easy maintenance.

### (3) Drainage from walkway roof

Ladders are provided to access to roof of walkway. Security anchor points for safety harness are provided. These facilitate maintenance with reduced risk of fall of persons.

### (4) Drainage pipes

Bathroom drainage pipes of domestic blocks are designed within a back panel system running along the inside faces the external wall. This design offers easy access for maintenance and avoids scaffolding for maintenance. Risk of fall of persons and falling objects are therefore minimized.

## 4.5 Finishes

### (1) Floor finish

Floor finish is specified to be non-slippery; thus reducing the risk of fall during occupation.

### (2) Specification

External coating is specified aiming for low maintenance. Qualities such as durability, resistance to acidic rain, resistance to capturing dirt and warranty requirement, etc. are studied. Precast elements are prefinished off-site with colour pigment, acid etched finish and deep penetrating chemical sealers. This reduces on site intensive labour applying traditional multi-layered acrylic paint.

## 4.6 Design Details for Easy Operation and Maintenance

### (1) Portable gondola

Electricity, structural support etc. are provided at locations envisaging portable gondola maintenance operation. Such provisions facilitate maintenance with reduced risks of fall of persons from height.

### (2) Access to planters

Access is provided directly from terrace, all with 1.2m railing protection plus anchor points for safety harness. Such provisions facilitate maintenance with reduced risks of fall of persons from height.

**(3) Glass parapet**

Fixing details are designed enabling easy procedure for glazing replacement, and so facilitate maintenance with reduced risks of fall of persons from height.

**(4) Window AC unit and Split AC unit**

AC platform is designed to be accessible from Balcony, thus avoiding risks of working at height during installation.

**(5) Balcony fixing**

Spot welding of bolts and nuts avoids loosening and avoids objects falling from height.

**(6) Window sash**

Openables are designed for cleaning consideration, also aiming to avoid working at height for maintenance.

**(7) Maintenance plan**

There is Maintenance plan and maintenance method statement, all coordinated with built-in provisions such as brackets and portable gondola for cleansing contractor.

## 5. Way Forward

### 5.1 Practicable Features of CDM

The value of CDM to avoid, reduce and manage residual risks throughout the design and construction process, involving key parties, is obvious. However, there may be some difficulties to operate the system in local context. Outlined below are a few suggestions introducing practicable features.

- It takes a mature industry, conversant and embracing safety and health values, to enable legal effective enforcement. Enforcement likened to legislation as in UK may spin off to burdensome defensive documentation in our local context.
- Clients have a unique influential role building up the value of designing for safety because they fund construction projects and own the product. The economic and moral values of construction services and product, which integrates CDM values, can be a motivation driving Clients to embrace the importance of designing for safety. There may be misconception that CDM leads to a more costly building.

This must be corrected. Positive values could be, for example, lower construction costs for a project with fewer accidents and disruptions, lower long term maintenance, operation and insurance costs, etc. Quality building is rewarding especially when life-cycle cost is considered in totality.

- Prior to considering rigid enforcement, the industry should be led to appreciate, understand and act out the values of designing for safety. These values should be so integrated that it becomes a matter of course in each respective profession. Education curriculum for students, continuous professional development programme for practitioners and contractors, partnering and value management workshops are worthy venues for this pursuit.

### **5.2 Design Guidelines and Design Meetings**

In line with 5.1 outlined, the Housing Department has been developing Design Guidelines educating and reinforcing CDM principles for various parties participating in construction projects. Prior to enforcement, these principles can be enlisted as Design Checklist and discussed in Design Review meetings. Such measures reinforce these principles to become essential and integral factors to be considered in the course of project development.



ISBN 962-968-260-5



9 789629 682606