

Introduction to Wastewater Treatment

Dr. Michael R. Templeton; Prof. David Butler



Download free books at

bookboon.com

Dr. Michael Templeton: Department of Civil and Environmental Engineering, Imperial College London, UK
Prof. David Butler: Centre for Water Systems, University of Exeter, UK

An Introduction to Wastewater Treatment



An Introduction to Wastewater Treatment

© 2011 Dr. Michael R. Templeton, Prof. David Butler & bookboon.com

ISBN 978-87-7681-843-2

Contents

	Preface	7
1	Introduction	8
1.1	The Aims of Wastewater Treatment	8
1.2	The Composition of Wastewater	8
1.3	Unit Processes in Wastewater Treatment	11
1.4	Process Selection and Design Considerations	12
1.5	Impact of Wastewater Effluent on Oxygen in Receiving Waters	13
2	Estimating Wastewater Quantities	16
2.1	Combined and Separate Sewers	16
2.2	Sources and Variability in Wastewater Flow	16
2.3	Dry Weather Flow	17
3	Preliminary Treatment	20
3.1	Screening	20
3.2	Grit Removal	21

In the past four years we have drilled

81,000 km

That's more than **twice** around the world.

Who are we?
We are the world's leading oilfield services company. Working globally—often in remote and challenging locations—we invent, design, engineer, manufacture, apply, and maintain technology to help customers find and produce oil and gas safely.

Who are we looking for?
We offer countless opportunities in the following domains:

- Engineering, Research, and Operations
- Geoscience and Petrotechnical
- Commercial and Business

If you are a self-motivated graduate looking for a dynamic career, apply to join our team.

What will you be?

Schlumberger

careers.slb.com

Click on the ad to read more

4	Sedimentation	24
4.1	Particle Settling	24
4.2	Ideal Sedimentation	28
4.3	Real Sedimentation and Settling Column Tests	29
4.4	Underflow and Solids Mass Flux	34
4.5	Sedimentation Tank Designs	36
4.6	Other Solids Removal Processes	39
4.6.1	Lamella Plate Settlers	40
4.6.2	Dissolved Air Flotation	41
4.6.3	Membrane Bioreactors	41
5	Biological Treatment	43
5.1	Biological Growth Kinetics	44
5.2	Activated Sludge	48
5.3	Attached Growth Processes	54
5.3.1	Trickling Filters	55
5.3.2	Rotating Biological Contactors	58
5.3.3	Submerged Aerated Biological Filters	59
5.4	Sludge Volume Index	60



**YOUR CAREER.
YOUR ADVENTURE.**

Ready for an adventure?

We're looking for future leaders.
Idea generators. And strategic thinkers.

We're looking for future leaders. Idea generators. And strategic thinkers. Put your degree and skills to work. We'll help you build the roadmap that's right for your career – including a few twists and turns to keep things interesting. If you have passion, a brilliant mind and an appetite to grow every day, this is the place for you.

Begin your journey: [accenture.com/bookboon](https://www.accenture.com/bookboon)

Strategy | Consulting | Digital | Technology | Operations

accenture
High performance. Delivered.



6	Nutrient Removal	61
6.1	Nitrification and Denitrification	61
6.2	Phosphorus Removal	63
7	Disinfection	66
8	Sludge Treatment	68
9	Wastewater Management in Developing Countries	73
10	Emerging Trends and Concerns in Wastewater Treatment	78
	References / Further Reading	80



Find and follow us: <http://twitter.com/bioradlscareers>
www.linkedin.com/groupsDirectory, search for Bio-Rad Life Sciences Careers
<http://bio-radlifesciencescareersblog.blogspot.com>



Your Profession is Your Passion. Pass it On.

John Randall, PhD
Senior Marketing Manager, Bio-Plex Business Unit

Bio-Rad is a longtime leader in the life science research industry and has been voted one of the Best Places to Work by our employees in the San Francisco Bay Area. Bring out your best in one of our many positions in research and development, sales, marketing, operations, and software development. Opportunities await — share your passion at Bio-Rad!

www.bio-rad.com/careers

BIO-RAD

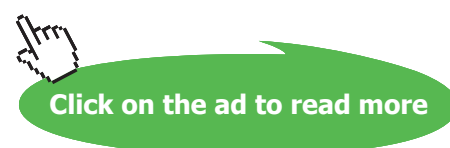

Preface

This book is intended to provide an introduction to the technical concepts of wastewater treatment. It assumes that the reader has at least a first-year undergraduate level of scientific understanding but not necessarily any previous knowledge of wastewater treatment. A reading list is provided at the end of the book for more in-depth information on the topics that are introduced here.

The authors are based in the United Kingdom and therefore the scientific units and terminology that are used in this book are those which are common in that country.

The authors acknowledge Prof Stephen R. Smith of the Department of Civil and Environmental Engineering at Imperial College London for his contributions to the sludge treatment chapter.

1 Introduction

1.1 The Aims of Wastewater Treatment

The traditional aim of wastewater treatment is to enable wastewater to be disposed safely, without being a danger to public health and without polluting watercourses or causing other nuisance. Increasingly another important aim of wastewater treatment is to recover energy, nutrients, water, and other valuable resources from wastewater.

1.2 The Composition of Wastewater

Wastewater, also called sewage, is mostly water by mass (99.9%) (Figure 1.1). The contaminants in wastewater include suspended solids, biodegradable dissolved organic compounds, inorganic solids, nutrients, metals, and pathogenic microorganisms.

The suspended solids in wastewater are primarily organic particles, composed of:

- Body wastes (i.e. faeces)
- Food waste
- Toilet paper

Inorganic solids in wastewater include surface sediments and soil as well as salts and metals.

The removal of suspended solids is essential prior to discharge in order to avoid settlement in the receiving watercourse. The degree to which suspended solids must be removed from wastewater depends on the type of receiving water into which the effluent is discharged. For example, the European Union (EU) Urban Wastewater Treatment Directive requires that effluent contains no more than 35 mg/l of suspended solids at 95% compliance, whereas the EU Freshwater Fish Directive sets a guideline level of 25 mg/l. A common target for suspended solids in the final discharged effluent in the United Kingdom is 30 mg/l, although the regulator may often choose to impose more stringent works-specific limits, called discharge consents.

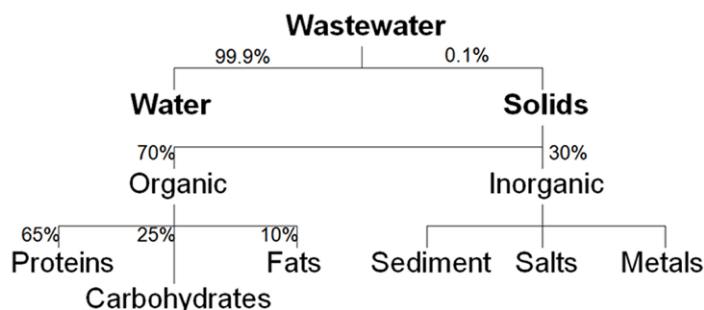

Figure 1.1. The typical approximate composition of domestic wastewater. Adapted from Tebbutt (1998).

The biodegradable organics in wastewater are composed mainly of:

- Proteins (amino acids)
- Carbohydrates (sugars, starch, cellulose)
- Lipids (fats, oil, grease)

These all contain carbon and can be converted to carbon dioxide biologically. Proteins also contain nitrogen. These biodegradable organics must be removed from wastewater or else they will exert an oxygen demand in the receiving watercourse.

Organic matter is typically measured as either Biochemical Oxygen Demand (BOD) or Chemical Oxygen Demand (COD). BOD is the most widely used parameter to quantify organic pollution of water. BOD is the measurement of the dissolved oxygen that is used by microbes in the biochemical oxidation of organic matter.

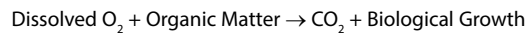

BOD measurements are used to:

- Determine the approximate quantity of oxygen required to react with organic matter
- Determine the sizing of the wastewater treatment works
- Measure the efficiency of some treatment processes
- Determine compliance with wastewater discharge permits or consents.

The steps in the laboratory method to measure BOD are:

- Measure a portion of wastewater sample into a 300 ml BOD bottle
- Add seed organisms, if required
- Fill the bottle with aerated dilution water
- Measure the initial dissolved oxygen (DO)
- Incubate the bottle at 20°C for 5 days in the dark (to determine BOD₅)
- Measure the final DO
- Calculate BOD₅.

For an unseeded sample, BOD is calculated as:

$$\text{BOD (mg/l)} = (D_1 - D_2) / P$$

where D_1 = initial DO (mg/l), D_2 = final DO (mg/l), and P = fraction of wastewater per total volume of dilution water and wastewater (e.g. 5 ml / 300 ml).

The initial depletion of DO is due to carbonaceous demand (Figure 1.2). The reproduction of nitrifying bacteria is slow, and it usually takes them 6-10 days to reach significant enough numbers to cause measurable oxygen demand. The later oxygen demand is mainly due to nitrification, i.e. the conversion of ammonia nitrogen to nitrate and nitrite.

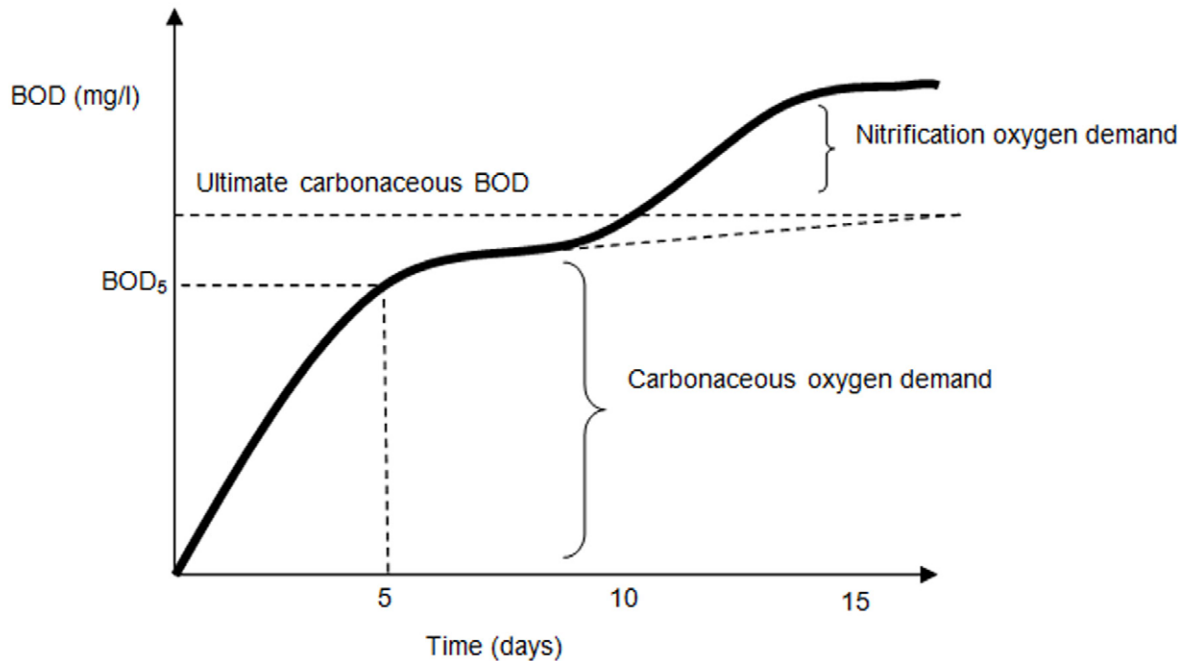

Figure 1.2. An example biochemical oxygen demand curve, showing the carbonaceous and nitrification oxygen demand components. Adapted from Viessman and Hammer (1998).

The asymptotic value is the ultimate carbonaceous oxygen demand (L_u), expressed mathematically as:

$$L_u = L_t / (1 - 10^{-kt})$$

where L_t = BOD at time t (mg/l), L_u = ultimate carbonaceous BOD (mg/l), k = BOD reaction rate constant (day^{-1}), and t = elapsed time of the test (days).

The limitations of the BOD test are that it:

- Takes five days to obtain a result
- Only measures biodegradable organics (i.e. not suitable for recalcitrant or toxic wastes)
- The 5-day period may or may not correspond to the point where soluble organic material has been degraded (e.g. cellulose can take longer to degrade).

Untreated domestic sewage typically has BOD in the range of 100-400 mg/l and a typical treatment target is to achieve BOD less than 30 mg/l, e.g. 80-90% reduction.

COD is a measure of the oxygen equivalent of organic matter susceptible to oxidation by a strong chemical oxidant, e.g. potassium dichromate. It is used to measure organic matter in industrial and municipal wastes containing chemical compounds that are toxic to biological life and/or not readily biodegraded. Typically COD has higher values than BOD, since there are many organics that are oxidised chemically that are only partially oxidised biologically. COD can be correlated with BOD for many wastes, which is beneficial since the COD test takes only a few hours versus a five-day analysis for BOD₅.

Effluent standards for BOD₅ and COD depend on the nature of the receiving watercourse. The EU Urban Wastewater Directive sets a BOD₅ limit in effluent of 25 mg/l at 95% compliance and a COD limit of 125 mg/l. The EU Freshwater Fish Directive sets a guideline for BOD₅ in effluent at less than 3 mg/l for protecting salmonid fish and less than 6 mg/l for protecting coarse fish.

Wastewater also typically contains nutrients such as nitrogen and phosphorus. These must be removed for several reasons including:

- The oxygen demand exerted in the receiving watercourse (e.g. nitrification of NH₃)
- Human toxicity concerns (e.g. nitrate causing methaemoglobinaemia in babies)
- Fish toxicity concerns (e.g. from ammonia)
- Eutrophication of receiving watercourses (e.g. from discharge of phosphorus-rich effluent).

There are also pathogenic microorganisms in wastewater including bacteria, protozoa, and viruses. These microorganisms are passed by infected people and pose a direct hazard to public health. It is impractical to monitor all types of microorganisms in wastewater on a regular basis, therefore indicator organisms are measured as surrogates. The most common indicator organisms are total and faecal coliforms. For example, the EU Bathing Water standards are 10⁴ total coliforms per 100 ml with 95% compliance and 2000 faecal coliforms (*E. coli*) per 100 ml with 95% compliance.

1.3 Unit Processes in Wastewater Treatment

Unit processes are individual treatment options for treating wastewater using either:

- Physical forces (e.g. gravity settling)
- Biological reactions (e.g. aerobic, anaerobic degradation), or
- Chemical reactions (e.g. precipitation).

A treatment train consists of a combination of unit processes designed to reduce wastewater contaminants to acceptable levels. Many different configurations and combinations of unit processes are possible to make up a treatment train, but a number of standard approaches have evolved.

Preliminary treatment is the removal of large/heavy debris at the beginning of the treatment train (see Chapter 3). Primary treatment is the subsequent removal of suspended inorganic and some organic particles, usually by sedimentation (see Chapter 4). Secondary treatment is the biological conversion of dissolved and colloidal organics into biomass and subsequent removal of the biomass by sedimentation (see Chapters 4 and 5). Tertiary treatment is the further removal of suspended solids or nutrients and/or disinfection before discharge to the receiving watercourse (see Chapters 6 and 7). Sludge treatment refers to the physical, chemical, and/or biological processing of sludge, collected mainly from the primary and secondary treatment stages (see Chapter 8).

1.4 Process Selection and Design Considerations

The choice of which unit processes to include in the treatment train takes into account a number of criteria including:

- Energy requirements
- Effectiveness in removing a particular target contaminant or set of contaminants
- Sludge generation and disposal requirements
- Complexity
- Reliability / robustness
- Flexibility / adaptability
- Operation & maintenance duties and costs
- Personnel requirements
- Construction costs
- Total costs.

**QUALIFY
FOR A GLOBAL
CAREER
IN ENGINEERING, ARCHITECTURE
OR TECHNOLOGY MANAGEMENT**

www.chalmers.se/masters>>

CHALMERS
UNIVERSITY OF TECHNOLOGY

The advertisement features a central purple starburst shape with seven circular images connected to it by purple lines. The images include: a modern building with a red facade, a person in a white shirt working at a computer workstation, a yellow spherical object with a grid pattern, a person working on a model with wooden blocks, a hand holding a glowing orange and yellow spiral, a large geodesic dome structure, and a person walking in front of a building with 'CHALMERS' signage.

A process flow diagram is a graphical representation of how unit processes make up a treatment train and how they interconnect (Figure 1.3).

Another important consideration is the hydraulic profile through the treatment train, which establishes the amount of head (i.e. water pressure) at each unit process. This establishes head requirements for pumps and ensures that the works will not be flooded or backed up during extreme conditions. Ideally a works should be sited to take advantage of gravity flow through the treatment train, where possible, to reduce energy requirements.

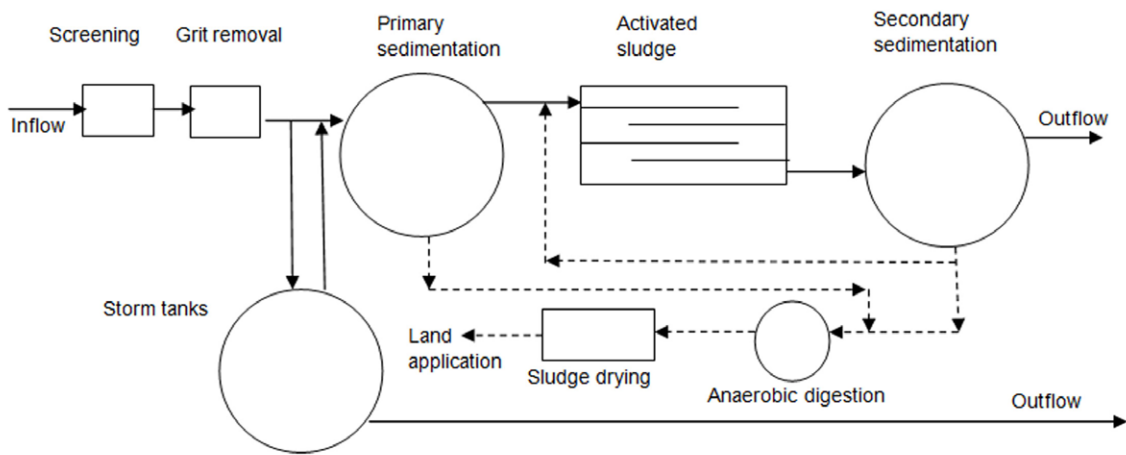

Figure 1.3. An example process flow diagram for a wastewater treatment train. Solid arrows show the flow of water while dashed arrows show the flow of sludge. Adapted from Tebbutt (1998).

1.5 Impact of Wastewater Effluent on Oxygen in Receiving Waters

Any organic matter remaining in the treated wastewater effluent (e.g. as BOD, organic nitrogen) is utilised by bacteria that are naturally present in the receiving watercourse, thereby consuming dissolved oxygen (DO). This reduction in DO can have harmful effects on higher forms of aquatic life (e.g. fish).

While the wastewater effluent introduces an oxygen demand, the DO is also continually replaced by the water surface being in contact with the atmosphere. There is therefore simultaneous de-oxygenation and re-aeration, resulting in what is commonly referred to as a 'DO sag' curve (Figure 1.4).

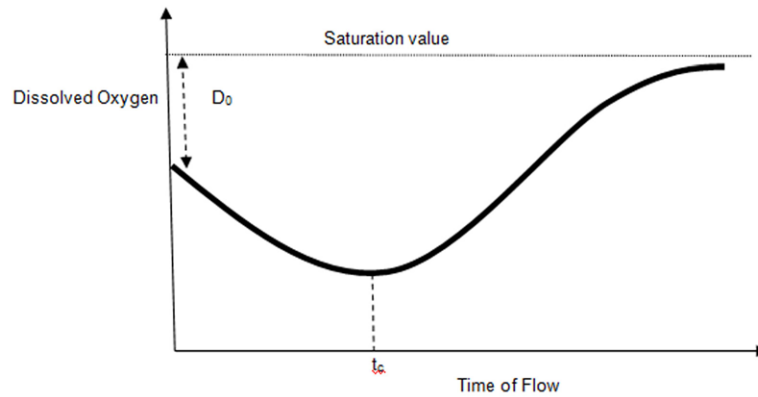

Figure 1.4. An example DO sag curve. Adapted from Viessman and Hammer (1998).

This curve can be described mathematically by the Streeter-Phelps equation:

$$D = [(k_1 \times L_0) / (k_2 - k_1)] \times [\exp(-k_1 \times t) - \exp(-k_2 \times t)] + D_0 \times \exp(-k_2 \times t)$$

where D = dissolved oxygen deficit = $C_s - C$, C_s is the DO saturation concentration (mg/l), C is the actual DO concentration, L_0 is the initial BOD of the wastewater effluent and receiving water at the point of mixture, t is time, k_1 is the coefficient of de-oxygenation, k_2 is the coefficient of re-aeration, and D_0 is the initial DO deficit in the receiving water. k_1 is a function of temperature while k_2 is a function of temperature and characteristics of the receiving water, specifically the depth and velocity of flow.

From the Streeter-Phelps equation, the critical time can be calculated as:

$$t_c = [1 / (k_2 - k_1)] \times \ln [(k_2 / k_1) \times (1 - D_0 \times (k_2 - k_1) / (k_1 \times L_0))]$$

The critical time is the point of maximum DO deficit and where the rate of re-aeration is equal to the rate of de-oxygenation. After t_c the rate of re-aeration is greater than the rate of de-oxygenation and the DO deficit is reduced. If the receiving water is a river or stream, multiplication of the t_c value by the flow velocity will provide an estimate of the distance downstream from the point of wastewater discharge at which the lowest DO concentrations will be experienced (i.e. the location of potential greatest negative impact on the aquatic environment).

The Streeter-Phelps equation has some limitations in that it does not include the following processes which may be relevant depending on the nature of the receiving water (Viessman and Hammer, 1998):

- Removal of BOD by adsorption or sedimentation in the receiving water
- Addition of BOD by a tributary flow
- Addition of BOD or removal of DO by a benthic sludge layer
- Addition of oxygen by photosynthesis (e.g. algae)
- Removal of oxygen by plankton respiration.



 Sweden
Sverige

Linköping University –
innovative, highly ranked,
European

Interested in Engineering and its various branches? Kick-start your career with an English-taught master's degree.

→ [Click here!](#)

li.u LINKÖPING
UNIVERSITY



2 Estimating Wastewater Quantities

2.1 Combined and Separate Sewers

A combined sewer carries stormwater and wastewater in the same pipe whereas a separate sewer network has two pipes which carry stormwater and wastewater separately. The pipe which carries wastewater in a separate sewer network is referred to as a foul sewer. The wastewater in a combined sewer is diluted by storm flow and so is typically less concentrated than the wastewater carried in a separate sewer network.

Wastewater treatment works which receive wastewater from combined sewer networks must make provisions for larger flows during storm events, such as storm tanks to store excess flow. The stored water is then returned to the works after the storm or discharged to a receiving watercourse during extreme storm events.

2.2 Sources and Variability in Wastewater Flow

Wastewater originates from domestic, commercial, and industrial sources. In many networks the domestic component is the largest. The defining variable is domestic water consumption, which is linked to human behaviour and habits. Very little water that is used by households is actually consumed, but rather is degraded in quality and then discharged as wastewater. Domestic water use is linked to a number of variables including:

- Climate. For example, water use tends to be highest when it is hot and dry, due largely to increased garden watering and irrigation.
- Demography. For example, household occupancy levels are linked to water use, with larger families having a lower per capita water demand. Also, retired people have been shown to use more water than the average for the rest of the population.
- Development type. For example, dwellings with gardens often use more water than those without gardens.
- Socio-economic factors. The greater the affluence or economic capabilities of a community the higher the water demand generally, likely due to greater ownership of water-using domestic appliances (e.g. power showers, dishwashers).
- Extent of metering and conservation measures. Metering typically results in less water usage. Water conservation measures may include low-flow taps/showers, low-flush toilets, and greywater recycling/reuse systems, all of which serve to reduce water demand.

Domestic water use also varies temporally for a number of reasons:

- Diurnal variation. On weekdays domestic wastewater generation peaks in the morning and evening when most people are at home.
- Weekly variation. Domestic wastewater generation tends to be higher on weekends and holidays, again due to more people being at home.
- Seasonal variation. Outside water use increases significantly in the summer. Toilet flushing decreases in summer, although bathing/showering increases.

- Long-term variations. The major long-term trend across the entire population in the United Kingdom is a steady increase in per capita water consumption, even though some people have taken steps to reduce their household water demand.

The average per capita water consumption in the United Kingdom is today (2011) typically estimated as approximately 160 litres per person per day. The toilet is the appliance which contributes the most to household water demand, accounting for almost a third of total domestic water use, followed by showers/baths, sinks, and laundry machines; even though toilets do not have as large a volume compared to other appliances, they have a higher frequency of usage. Per capita water consumption may well *decrease* in the future given the increased emphasis on water conservation and efficiency.

Commercial water use includes the water used in shops, offices, and light industrial units, as well as restaurants, laundries, public houses, and hotels. Water demand is mainly generated from drinking, washing, and sanitary facilities; toilet/urinal usage is an even higher component of the total water consumption than in households, accounting for nearly half of the total water demand in commercial buildings.

Industrial water use can be a very important contributor of wastewater flow depending on the region and the nature of the industry. Industrial wastewater effluent may originate from processing (e.g. manufacturing, waste and by-product removal, transportation), cooling, cleaning, as well as sanitary uses. The rate of discharge varies significantly from industry to industry and is generally expressed in terms of water volume used per mass of product (e.g. papermaking is 50-150 m³/tonne, dairy products are 3-35 m³/tonne). The timing of generation of industrial effluents can be highly variable depending on operational start-ups and shutdowns, batch discharges, and working hours.

Water may also ingress into a foul sewer as infiltration, which is when extraneous groundwater or water from other nearby pipes enters the sewer through defective drains and sewers (e.g. cracked/leaking sewer pipes), pipe joints and couplings, or manholes. The extent of infiltration is site-specific but influencing variables include the age of the network, settlement due to ground movement, the height of the groundwater level, the frequency of pipe surcharge, and the standard of materials used. In addition, water may ingress into a foul sewer by what is called inflow, which is when stormwater enters the foul sewer through either accidental or illegal misconnections, yard gullies, roof downpipes, or through manhole covers.

2.3 Dry Weather Flow

Wastewater flows are quantified in terms of what is known as Dry Weather Flow (DWF), which can be defined as the average daily flow during seven consecutive days without rain (excluding a period which includes a holiday) following seven days during which the rainfall did not exceed 0.25 mm on any given day. In other words, the DWF is the average flow of wastewater which is not immediately influenced by rainfall (Figure 2.1).

The DWF includes domestic, commercial, and industrial flows and infiltration, but excludes direct stormwater inflow. DWF can be expressed as:

$$\text{DWF} = P \cdot G + I + E$$

where P is the number of people served by the sewer network, G is the per capita domestic water consumption, I is the infiltration amount, and E is the industrial effluent (sometimes referred to as trade effluent). P can be estimated by using official census data and considering future population trends, trade/industrial developments, and housing density patterns. G is estimated as 200 litres per person per day in the United Kingdom; special allowances should be made for water use in schools, hospitals, nursing homes, etc. Infiltration is difficult to quantify and a common approach is to simply assume a value of 10% of the domestic wastewater flow (e.g. 20 litres per person per day), although this may be too low in areas with high groundwater levels (i.e. where there is a higher likelihood of ambient water coming in contact with the sewer and entering the sewer). Estimation of the trade effluent should consider the types of industry and whether there are water-saving measures in place or not (e.g. recycling water internally, where possible); light industry may be estimated to have an average water consumption in the range of 2 litres per second per hectare of industrial land, ranging up to 8 litres per second per hectare of industrial land in heavily water-consuming industries.



The advertisement for Factcards.nl features a dark background with a light blue logo consisting of a square and a vertical bar. Below the logo, the text asks if the user is working in academia, research, or science and if they have ever thought about working and moving to the Netherlands. Five colorful cards represent different categories: Arriving (33), Living (50), Studying (51), Working (101), and Research (50). A light blue button at the bottom right says 'VISIT FACTCARDS.NL'. To the right of the cards, text explains that the site offers information for career advancement in the Netherlands, categorized by arriving, living, studying, working, and research, and is accessible from smartphones or desktops.

FACTCARDS

Are you working in academia, research or science? And have you ever thought about working and moving to the Netherlands?

Arriving 33

Living 50

Studying 51

Working 101

Research 50

Factcards.nl offers all the **information** that you need if you wish to proceed your **career** in the **Netherlands**.

The information is ordered in the categories arriving, living, studying, working and research in the Netherlands and it is freely and easily accessible from your smartphone or desktop.

VISIT FACTCARDS.NL

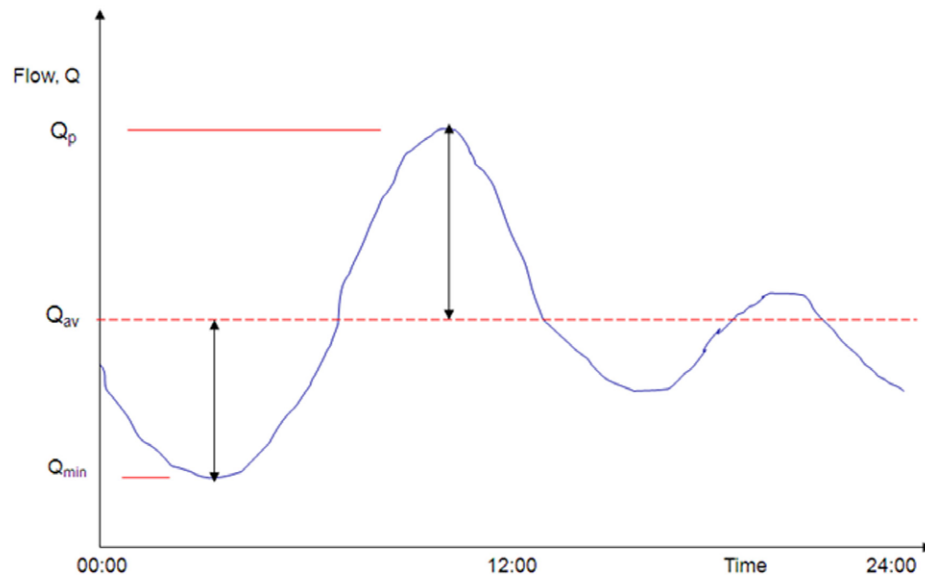

Figure 2.1. An example variation in wastewater flow over the course of a day, showing the average flow (DWF) and peak flow.
Adapted from Butler and Davies (2011).

In the United Kingdom a typical flow for designing the unit processes in wastewater treatment works is 3 x DWF, which allows for the diurnal peaks in flow above the average (DWF) flow. This is sometimes known as 'flow to full treatment'. In combined sewer networks the incoming flow to a wastewater treatment works will sometimes exceed this 3 x DWF design flow. In these cases water is usually diverted to storm tanks (see Figure 1.3) which store the water for a certain period of time. A common design approach is to provide storm tank capacity to allow two hours of storage at flows between 3 x DWF and 6 x DWF.

3 Preliminary Treatment

The aim of preliminary treatment processes is to remove large and/or heavy debris which would otherwise interfere with subsequent unit processes or damage pumps and other mechanical equipment in the treatment works. Typically preliminary treatment includes screening and grit removal steps.

3.1 Screening

Screening is the first step of treatment in a wastewater treatment works. The objective of screens is to remove large floating debris, such as rags (~60%), paper (~25%), and plastics (~5%). The materials that are removed from the water by the screens are referred to as screenings. Screenings have a bulk density of approximately 600-1,000 kg/m³, moisture content of 75-90%, and volatile content of 80-90%.

There is very sparse data available on the volume of screenings removed, which depends on the size of the openings in the screen, however an estimate of the daily screening volume collected is between 0.01-0.03 m³/day per 1,000 people served.

Common types of screens are bar screens, drum screens, cutting screens, and band screens.

A bar screen consists of parallel inclined metal bars, placed normal to the wastewater flow. Coarse bar screens have openings of 20-60 mm between the bars, whereas fine bar screens have openings of 6-20 mm between the bars. Fine bar screens are often placed downstream of coarse screens. Cleaning of the screens is typically accomplished either manually or via a mechanical raking system.

A drum screen consists of a hollow mesh drum, normally 2-5 m in diameter, which rotates about its horizontal axis. The wastewater enters the drum axially and leaves radially, trapping the screenings inside the drum. Water jets then periodically clear the screenings from the drum.

A cutting screen is an adaptation of a bar screen but with a cutting mechanism which sheds the screenings into smaller pieces and allows them to pass through the screen. However, these screens are not favoured in most works as the screenings will be removed with the sludge, making sludge reuse problematic.

Band screens consist of perforated panels (e.g. with 6 mm holes), usually stainless steel, mounted on constantly rotating conveyor belts.

The velocity of flow through screens is typically in the range of 0.5-0.9 m/s, which avoids forcing screenings through the screens but also is not too slow to allow grit to settle in the screen channels.

Headloss is not normally calculated for screens and is typically quite low, especially when the screens are clean – i.e. limited to 100-150 mm. Standard practice is to install a second screen as a standby and to provide a by-pass channel in case of screen blockages.

The width of the screen channel can be designed using the following formula:

$$W = (Q / (v \times D)) \times ((B + S) / S) + C$$

where W = screen width (m), Q = maximum flow (m^3/s), v = velocity through the screen (m/s), D = depth of flow (m), B = width of bar (mm), S = bar spacing (mm), and C = allowance for side frame.

In some cases the collected screenings can be de-watered, depending on the composition of the screenings; fibrous material is easily de-watered whereas organics are not. Typical de-watering methods include by ram press, screw press, belt press, or centrifuge. However, de-watered screening moisture content is still typically 50-60%.

There is generally a desire for fast and efficient disposal of screenings, since they are contaminated with raw faecal material and are odorous. Handling of screenings should be minimised by using conveyors, wagons or bagging systems. Screenings are normally collected in skips and taken to landfill or in some cases incinerated.

3.2 Grit Removal

The second step of preliminary treatment immediately downstream of screening is normally grit removal. Grit includes heavy inorganic particles such as sand, gravel, and other heavy particulate matter (e.g. corn kernels, bone fragments, coffee grounds). For design purposes grit is normally considered as fine sand, with a diameter of 0.2 mm, specific gravity of 2.65 mm, and a settling velocity of 20 mm/s. As with screenings, there are no established standard test procedures to determine grit characteristics, however the bulk density is approximately 800 kg/m^3 , the moisture content ranges between

3 PHYSICIANS. 24 HOURS.

Immerse yourself in a day in the life of military physicians who practice medicine in unexpected ways.

+ GO NOW

10-85%, and the volatile content is typically 10-30%. Grit has the physical characteristics of saturated sand – i.e. heavy, moderately cohesive, and should be low in organic content.

Grit removal is an important preliminary treatment process for several reasons:

- To protect mechanical equipment and pumps from abrasive wear
- Prevent pipe clogging by deposition of grit
- Reduce accumulation of grit in settling tanks and digesters.

Grit is removed by settling in grit channels. The two main types of grit channels are constant velocity grit channels and aerated grit channels.

Constant velocity grit channels consist of a channel with a parabolic base and a downstream velocity control device, such as a Venturi flume. The velocity in the channel is thereby maintained constant (e.g. 0.3 m/s) at all flow rates and depths. The grit settles in the channel in 30-60 seconds and is then sucked or scraped from the bottom of the channel, e.g. via chain-mounted buckets or vacuum pumping.

The depth of flow (h) in the grit channel is controlled by the magnitude of flow:

$$h = (Q / (C \times b))^{2/3}$$

where b = flume throat width and C = constant, depending on the flume geometry.

The area of flow through the parabolic channel (A) can be calculated as:

$$A = 2/3 \times W \times h$$

The surface width of the channel can be calculated as:

$$W = (3 \times Q) / (2 \times h \times v)$$

The length of the grit channel depends on the ratio of the settling velocity particles (v_s) to the horizontal velocity of flow (v):

$$v / v_s = L / h_{\max}$$

where h_{\max} is the maximum depth of flow.

For example, if $v = 0.3$ m/s and $v_s = 20$ mm/s (for grit), then L is approximately $15 \times h_{\max}$.

Another important grit channel design variable is the particle scour velocity (v_h), which is the velocity at which particles will be picked up from the bottom of the channel and re-introduced into the flow. This can be calculated as:

$$v_h = ((8 \times \beta \times (S-1) \times g \times d) / f)^{1/2}$$

where β and f are constants depending on the particle type and S is the specific gravity. The horizontal velocity of flow through the channel should be close to but not more than the scour velocity of grit to ensure removal of grit but non-retention of organic particles, since it is desirable for the latter to continue on to the subsequent biological treatment stage.

Aerated grit channels use a spiral motion (induced by aeration) to settle grit but not organics. These channels have the advantages of space savings, providing pre-aeration to the water, and improving suspended solids reduction. The air requirements are 0.3-0.7 m³ per minute per metre of length of channel. The typical depth is 3-5 m and the length-to-width ratio is 3:1 – 5:1. The hydraulic retention time under peak flow conditions is typically on the order of 3 minutes. These channels are able to capture up to 95% of 0.2 mm diameter grit.

Other types of grit removal processes are detritors and vortex-type grit removers. Detritors are shallow circular sedimentation tanks with rapidly rotating scrapers; these typically achieve poor separation of organic particles from grit. Vortex-type grit removers are mainly commercially developed designs, whereby grit is collected in the centre of the vortex.

The quantity of grit removed varies widely, depending on the type of sewer network (combined versus separate), local geology (i.e. dictating the type of sand/gravel that may occur as grit in the wastewater), and other factors. For a combined sewer network, 0.05-0.10 m³ grit per 1000 m³ of wastewater may be typical, whereas for a separate sewer network the range is 0.005-0.05 m³ grit per 1000 m³ of wastewater. Grit can be used as a fill material (if sufficiently clean) or sent to landfill or other solid waste handling facilities.

4 Sedimentation

Wastewater contains impurities which in flowing water will remain in suspension but in quiescent water will settle under the influence of gravity. The sedimentation process, also called 'settling' or 'clarification', exploits this phenomenon and is used for the separation of solids from water and the concentration of separated solids. Sedimentation is used in both the primary and secondary treatment stages of wastewater treatment.

4.1 Particle Settling

There are four classes of particle settling (Figure 4.1):

- Discrete settling (Class I)
- Flocculent settling (Class II)
- Hindered settling (Class III)
- Compression settling (Class IV)



.....Alcatel-Lucent 

www.alcatel-lucent.com/careers

What if you could build your future and create the future?

One generation's transformation is the next's status quo. In the near future, people may soon think it's strange that devices ever had to be "plugged in." To obtain that status, there needs to be "The Shift".



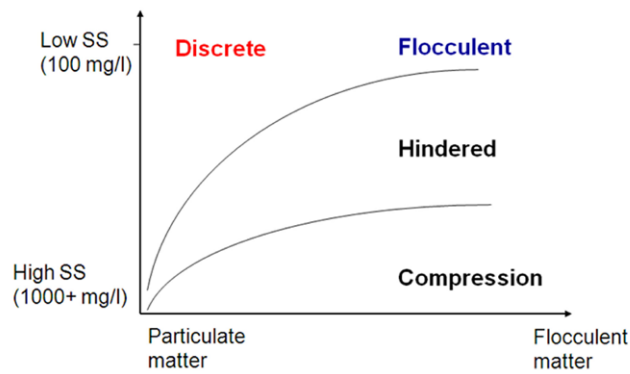

Figure 4.1. The occurrence of the four classes of particle settling based on suspended solids (SS) concentration and the nature of the suspended matter (particulate versus flocculent).

Discrete particle settling occurs at low suspended solids concentrations (i.e. low hundreds of mg/l) and involves discrete, non-flocculent particles. In other words, particles settle individually without coming into contact with each other. Grit settling in a grit channel can be approximated as discrete settling, for example. All four classes of settlement can occur in the same sedimentation basin (Figure 4.2).

An object settling in a water column will have three forces exerted on it: a gravity force (F_w), buoyant force (F_b), and a drag force (F_d) (Figure 4.3), the latter being a function of velocity.

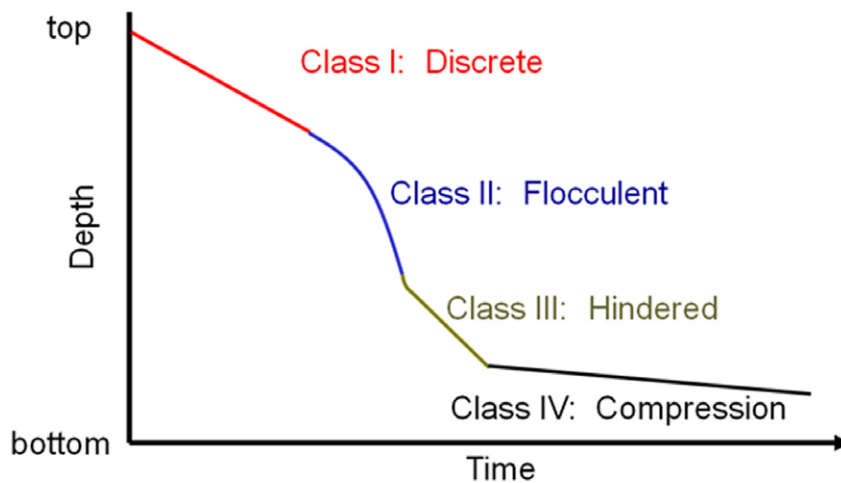

Figure 4.2. The occurrence of the four classes of particle settling based on depth within a sedimentation basin and settling time.

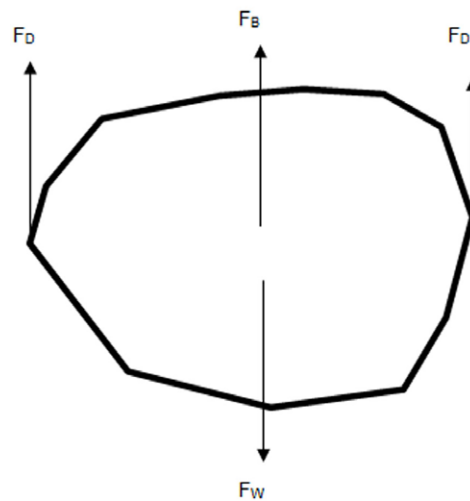

Figure 4.3. The forces acting on a settling particle.

Individual particles will continue to accelerate downward until the net gravity force ($F_W - F_B$) is balanced by the drag force (F_D):

$$F_D = F_W - F_B$$

$$F_D = (\rho_s - \rho) \times g \times V_s$$

where ρ_s = density of particle, ρ = density of fluid, g = acceleration due to gravity, and V_s = volume of the solid particle.

The drag force is a function of the particle settling velocity (v_s), the diameter of the particle (d), the density of the fluid, and the projected area of the particle (A):

$$F_D = \frac{1}{2} \times C_D \times A \times \rho \times v_s^2$$

where C_D is the drag coefficient.

Combining and re-arranging equations yields a relationship for the settling velocity of discrete particles:

$$v_s = \left(\frac{2 \times (\rho_s - \rho) \times V_s}{C_D \times A \times \rho} \right)^{1/2}$$

For spherical particles:

$$V_s = \frac{\pi \times d^3}{6} \text{ and } A = \frac{\pi \times d^2}{4}$$

By substituting these values for spheres, a new expression for the particle settling velocity is:

$$v_s = (4/3 \times (g \times d) / C_D \times (\rho_s - \rho))^{1/2}$$

or

$$v_s = (4/3 \times (g \times d) / C_D \times (S-1))^{1/2}$$

where S = specific gravity of the particle = ρ_s / ρ .

C_D is a function of the Reynolds number, Re , which in turn is related to fluid density, fluid viscosity (μ), particle diameter, and particle settling velocity:

$$Re = (v_s \times \rho \times d) / \mu$$

The relationship between C_D and Re varies based on the flow regime:

For $Re < 1$ (laminar flow): $C_D = 24 / Re$

For $1 < Re < 10^4$ (transitional flow): $C_D = 24 / Re + 3 / Re^{1/2} + 0.34$

For $Re > 10^4$ (turbulent flow): $C_D \approx 0.4$



Think Umeå. Get a Master's degree!

- modern campus • world class research • 31 000 students
- top class teachers • ranked nr 1 by international students

Master's programmes:

- Architecture • Industrial Design • Science • Engineering

Umeå University
Sweden
www.teknat.umu.se/english



In sedimentation in wastewater treatment, it can often be assumed that conditions are laminar. Combining the laminar flow equation for C_D above with the previously derived equation for v_s (assuming spherical particles) produces the following relationship, known as Stokes' law:

$$v_s = g / 18 \times [(\rho_s - \rho) / \mu] \times d^2$$

or

$$v_s = g / 18 \times [(S-1) / \nu] \times d^2$$

where μ = dynamic viscosity and ν = kinematic viscosity, which are related by: $\mu = \nu / \rho$.

4.2 Ideal Sedimentation

Consider a horizontal flow sedimentation basin (Figure 4.4) operating under the following assumptions:

- The particle concentration is the same at all depths in the inlet zone
- Flow is steady
- Once a particle deposits, it is not re-suspended
- The flow-through period is equal to the hydraulic detention time
- Settling particles are discrete.

Now consider three particles entering this basin at the top of the inlet zone (Figure 4.5). In this figure, v = horizontal velocity and v_o = the settling velocity of the smallest particle that will be 100% removed by the basin, also known as the overflow rate (or surface overflow rate).

Particle A settles at the overflow rate (v_o) in Figure 4.5. Particles with settling velocities greater than v_o (i.e. Particle B in the figure) will also be 100% removed.

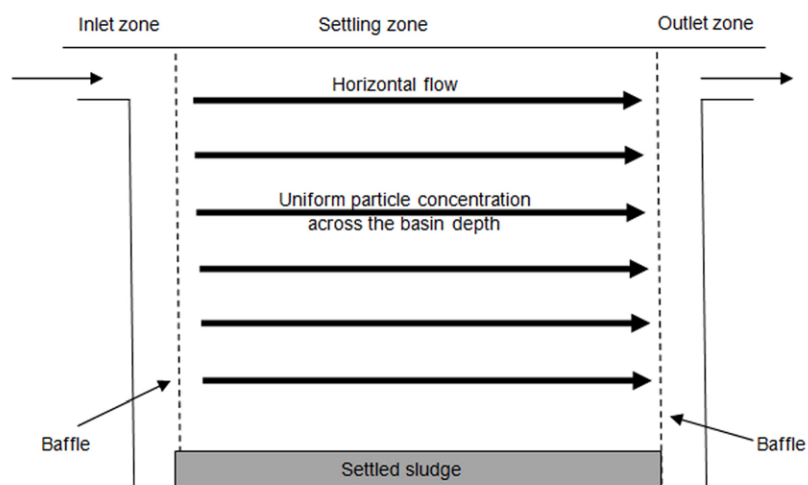

Figure 4.4. An ideal sedimentation basin.

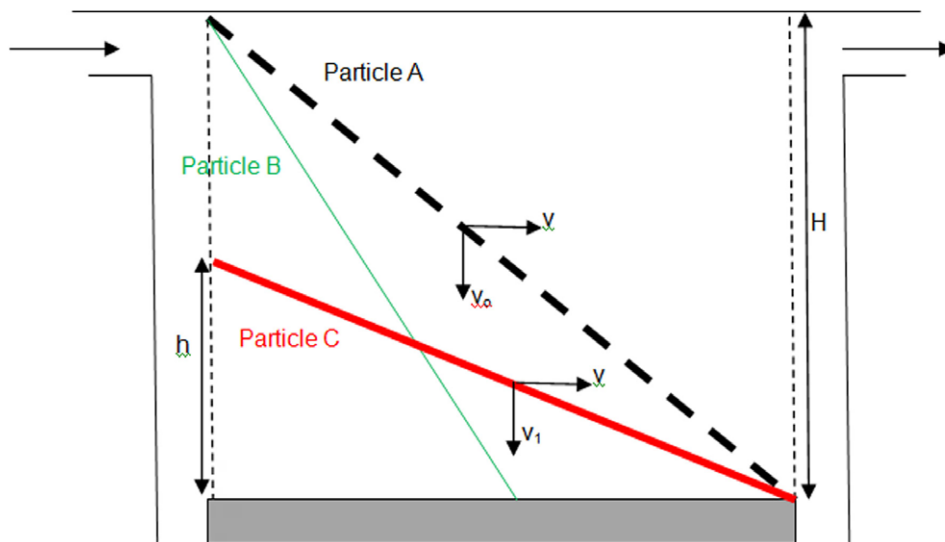

Figure 4.5. An ideal sedimentation basin with three particles settling at different velocities. Particle A (bold black dashed line) settles at the overflow rate (v_o), Particle B (un-bolded solid green line) settles faster than Particle A, and Particle C (bold red solid line) settles more slowly than Particle A. Adapted from Tebbutt (1998).

Particles with settling velocities less than v_o (i.e. Particle C in Figure 4.5, settling at a velocity v_1) will only be partially removed, according to the ratio:

$$\% \text{ Removal} = v_1 / v_o \times 100\% = h / H \times 100\%$$

where v is the settling velocity of the particle, H is the total depth of water in the basin, and h is the maximum height at which the particle can enter the basin and still be removed by the basin (as shown in Figure 4.5 for Particle C). For example, if Particle C has a settling velocity that is one half of the v_o , then 50% of particles with the same settling velocity as Particle C will be removed by the basin.

The overflow rate has units of $\text{m}^3/\text{m}^2/\text{day}$ and may be expressed as:

$$v_o = Q / A$$

where Q is the flow rate through the basin (in m^3/day) and A is the floor area of the settling zone in the basin (in m^2). For example, if the overflow rate is $5 \text{ m}^3/\text{m}^2/\text{day}$ and the basin has an area of 100 m^2 , then a maximum of $500 \text{ m}^3/\text{day}$ can be discharged through the basin in order to guarantee 100% removal of particles with a settling velocity of 5 m/day or greater.

4.3 Real Sedimentation and Settling Column Tests

In practice, with wastewater containing mixtures of particles of different settling velocities, experimental analysis is required to determine the overall removal of particles by a sedimentation basin with a given overflow rate. The common experimental analysis is the settling column test, in which a sample of the wastewater is placed in a column and thoroughly mixed to create a uniform concentration of suspended particles throughout the depth of the column (Figure 4.6). The concentration of suspended solids is then measured from a sampling port near the bottom of the column over a range of time intervals, and percent removal is calculated by comparing the concentration at each sampling time to the initial concentration. The settling velocities of the particles can be calculated by dividing the column depth by the time of sampling. Plotting the settling velocities versus the fraction remaining in suspension yields a curve similar to the example shown in Figure 4.7. The fraction of particles removed is then expressed as:

$$X = (1 - x_0) + \int_0^{x_0} \frac{v_s}{v_o} dx$$

where $(1-x_0)$ represents the fraction of particles with settling velocity greater than the overflow rate, and the integral part of the equation represents the fraction of particles that settle slower than the overflow rate, for which only a fraction will be removed in the ratio of v_s/v_o . This integral can be calculated manually by estimating the area above the curve in plots of the form of Figure 4.7, up to the fraction corresponding to the overflow rate.

How could you take your studies to new heights?

- By thinking about things that nobody has ever thought about before
- By writing a dissertation about the highest building on earth
- With an internship about natural hazards at popular tourist destinations
- By discussing with doctors, engineers and seismologists
- By all of the above

From climate change to space travel – as one of the leading reinsurers, we examine risks of all kinds and insure against them. Learn with us how you can drive projects of global significance forwards. Profit from the know-how and network of our staff. Lay the foundation stone for your professional career, while still at university. Find out how you can get involved at Munich Re as a student at munichre.com/career.



Munich RE 

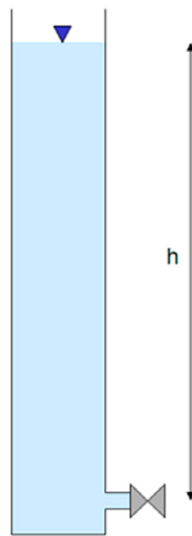

Figure 4.6. Class I (Discrete) settling column test apparatus.

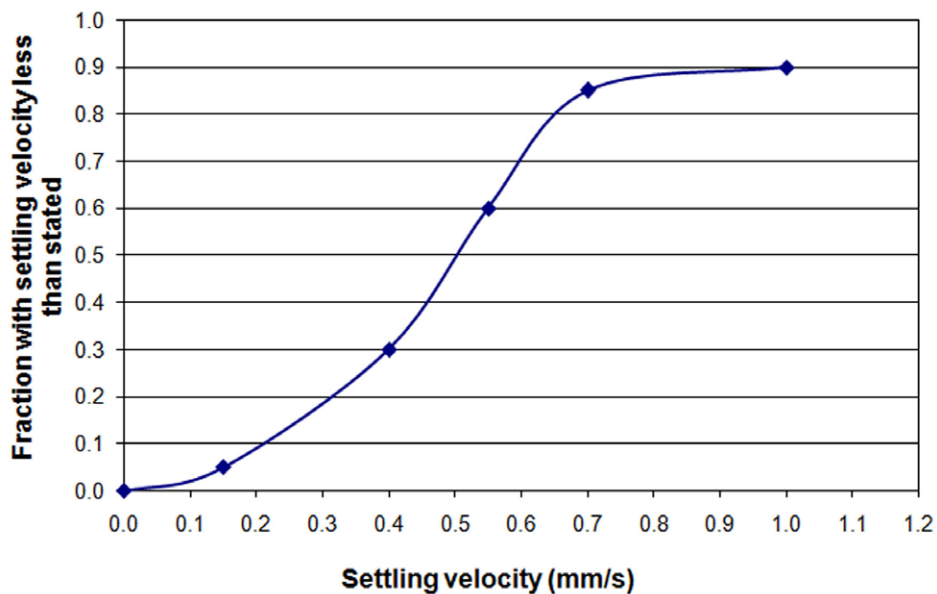

Figure 4.7. Example data from a Class I settling column test.

For cases where Class II settling predominates (Figure 4.8), e.g. primary sedimentation in wastewater treatment, flocculation occurs during sedimentation due to:

- Differences in settling velocity of particles, as faster settling particles overtake slower ones and coalesce
- Velocity gradients within the liquid causing particles in regions of higher velocities to overtake those in slower-moving regions.

The settling column test apparatus for a Class II design is shown in Figure 4.9. As in the Class I test, the test begins with the wastewater being mixed so that there is an approximately uniform concentration of particles throughout the column at the start of the test. Sampling is then conducted from each of the ports at different depths over a range of time intervals. From calculation of percent removal at each depth and time and interpolation, a plot of iso-removal lines can be constructed (Figure 4.10).

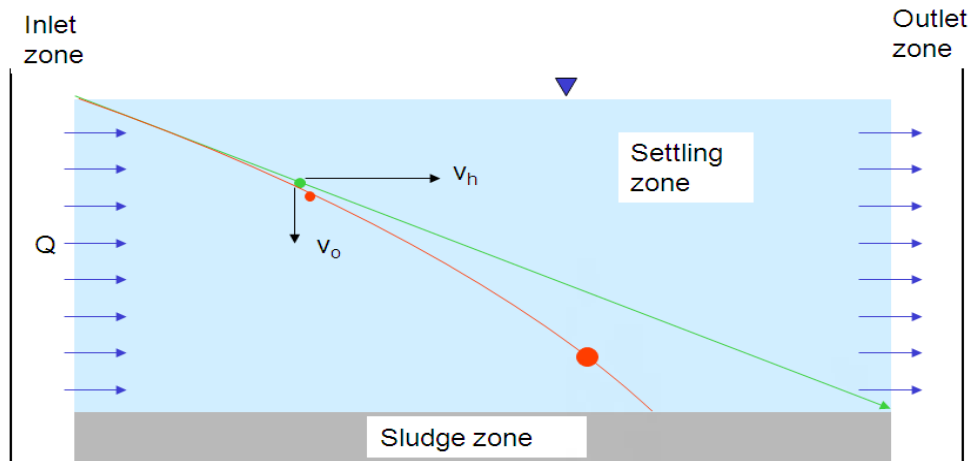

Figure 4.8. Schematic representation of Class 2 flocculent settling.

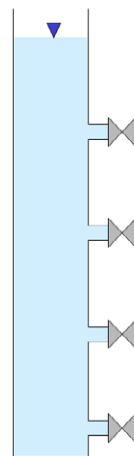

Figure 4.9. A Class II (Flocculent) settling column apparatus.

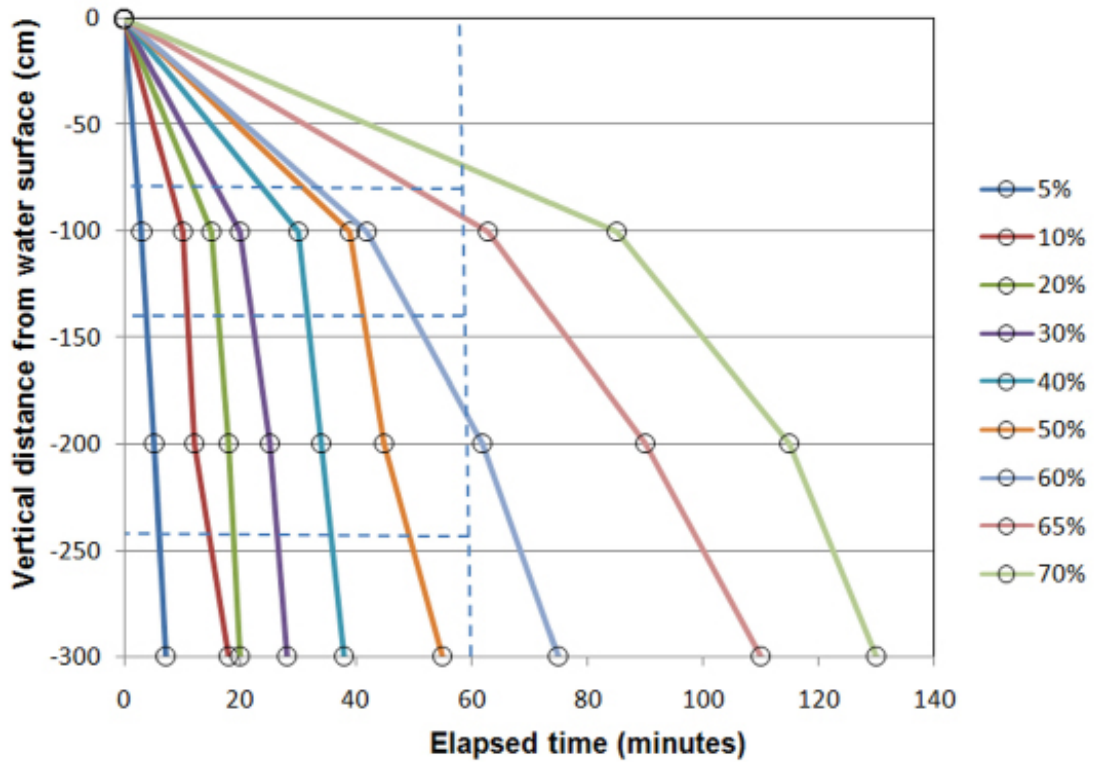

Figure 4.10. Example percent iso-removal data from a Class II settling column test.

26 destinations 4 continents
 Bartending is your ticket to the world

EUROPEAN BARTENDER SCHOOL [GET STARTED](#)



The total removal (X) can be estimated from this plot by drawing a vertical line at the mean hydraulic residence time of the basin (e.g. at 60 minutes in Figure 4.10), and using the following equation:

$$X = r_0 + \Sigma (h \times \Delta x) / h_0$$

where r_0 is the percent removal determined at the bottom of the basin (e.g. approximately 52% or 0.52 in Figure 4.10), h_0 is the total basin depth (e.g. 300 cm in Figure 4.10), h is the depth at each midpoint between two iso-removal lines where the vertical line crosses (e.g. 140 cm in Figure 4.10, for the midpoint between the 60% and 65% iso-removal lines), and Δx is the different in percent removal between the two iso-removal lines (e.g. for the midpoint between the 65% and 60% iso-removal lines, $\Delta x = 0.05$).

In real sedimentation tank design, the overflow rate would be set by assuming only a percentage of the particle removal performance that is achieved in a settling column test (e.g. 50%), due to effects at full-scale which are not considered in the column test, such as wind effects, inlet/outlet disturbances, and hydraulic short-circuiting.

4.4 Underflow and Solids Mass Flux

For secondary clarifier design, where there are high concentrations of solids in the influent (i.e. biomass from the preceding biological treatment process), hindered and zone settling (i.e. Classes III and IV) predominate through most of the depth of the clarifier. Movement of solids downwards is a function of gravity settling and underflow, which refers to the withdrawal of solids from the bottom of the clarifier, e.g. by opening a valve and/or pumping (Figure 4.11).

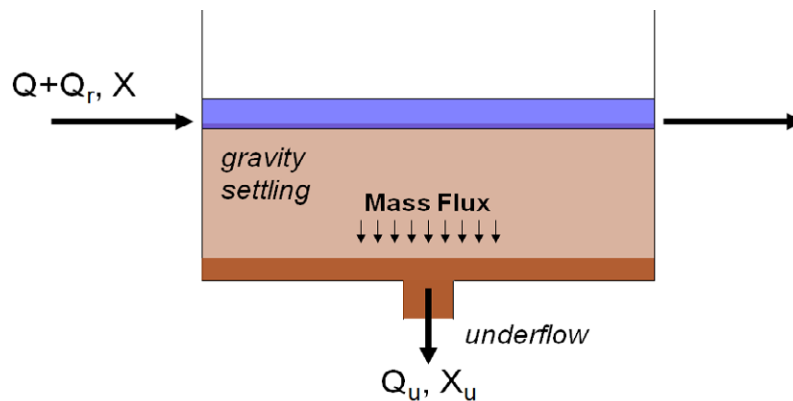

Figure 4.11. Solids mass flux downwards due to gravity settling and underflow.

The solids mass movement rate (kg per hour) can be calculated:

$$\text{Solids mass movement rate} = v_g \times X \times A + Q_u \times X_u$$

where X is the biomass concentration, A is the floor areas of the sedimentation basin, v_g is the hindered settling velocity due to gravity, Q_u is the underflow rate, and X_u is the underflow sludge concentration.

Solids mass flux (represented by the variable G and with units of kg per m^2 per hour) can therefore be calculated as:

$$\text{Solids Mass Flux} = G = G_g + G_u = v_g \times X + (Q_u / A) \times X_u$$

where G_g is the gravity settling flux and G_u is the underflow flux. The term Q_u / A is sometimes expressed as v_u , underflow rate (with units of velocity). This is represented graphically in Figure 4.12 below.

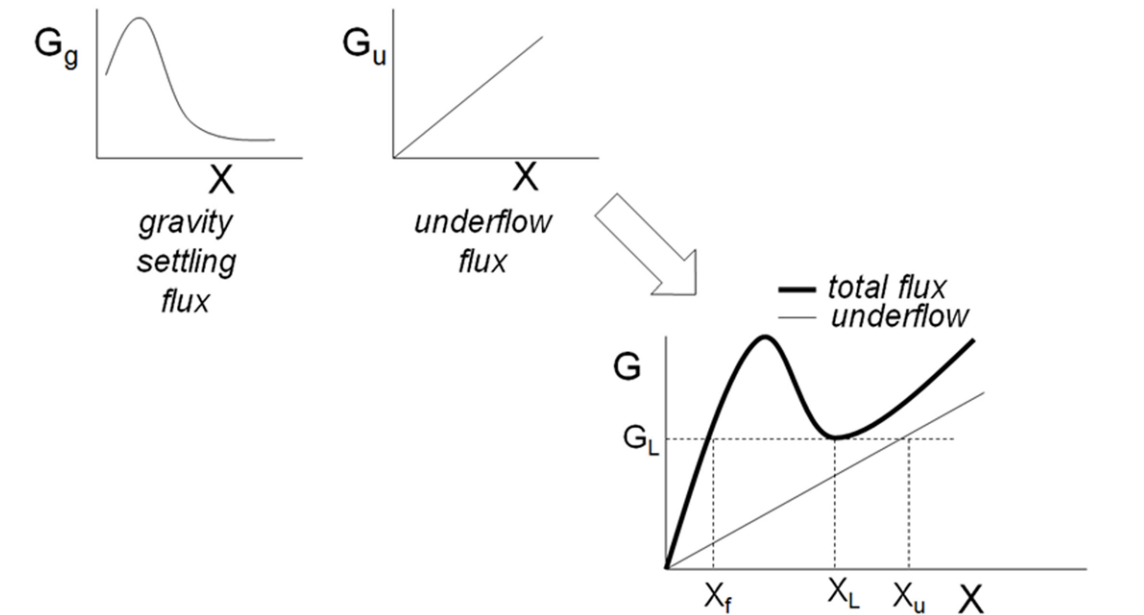

Figure 4.12. Plotting total solids mass flux by combining gravity settling flux and underflow flux.

There is a limiting solids flux (G_L) which, for a given Q_u , determines the appropriate X_u (Figure 4.12). G_L is associated with a limiting solids concentration, X_L . Normal operation should encompass the limiting solids concentration, since the influent feed concentration (X_f) is less than X_L and the underflow concentration, X_u , is greater than X_L .

Changing Q_u (e.g. by increasing or decreasing the underflow pumping rate) shifts the underflow flux line upward or downward; since G_u can be controlled, it is the main process control variable.

The applied flux (G_{applied}) should not exceed the limiting flux or else there will be an accumulation of solids in the clarifier and solids will eventually be transferred into the effluent of the clarifier.

$$G_{\text{applied}} = [(Q + Q_r) \times X] / A$$

To ensure $G_L > G_{\text{applied}}$:

$$A > [(Q + Q_r) \times X] / G_L$$

Excessive solids in the secondary effluent (i.e. more than would be expected from the theory given above) may be explained by factors such as:

- Hydraulic short-circuiting or turbulence in the clarifier
- Thickening overloads (a flux imbalance)
- Denitrification in the settling tank (nitrogen bubbles floating particles to the surface)
- Flocculation problems (solids break-up and float to the surface, e.g. due to disruption of settling by the motion of a mechanical scraper)
- Insufficient Q_u capacity.

Generally, a depth of at least 3 m is needed in secondary clarifiers, to avoid hydraulic issues and allow enough space for short-term storage of settled sludge.

4.5 Sedimentation Tank Designs

The most common designs of sedimentation tanks (also called 'clarifiers') are the rectangular tank, whereby the water enters one end and flows horizontally to the other end and over a weir, or the circular tank design, whereby the water enters through an inlet at the centre of the tank and flows radially outwards towards a weir which runs around the circumference of the tank (Figure 4.13). In both of these varieties there is a mechanical scraper which moves slowly along the bottom to direct settled solids along a slightly sloped floor into a collection area on the floor of the tank, where the solids are usually removed periodically by pumping or a valve. Rectangular basins have length-to-width ratios of typically 3:1 to 5:1 and a bottom slope of approximately 1%.



DON'T EAT YELLOW SNOW

What will your advice be?

Some advice just states the obvious. But to give the kind of advice that's going to make a real difference to your clients you've got to listen critically, dig beneath the surface, challenge assumptions and be credible and confident enough to make suggestions right from day one. At Grant Thornton you've got to be ready to kick start a career right at the heart of business.

Sound like you? Here's our advice: visit GrantThornton.ca/careers/students

Scan here to learn more about a career with Grant Thornton.



 **Grant Thornton**
An instinct for growth™

© Grant Thornton LLP. A Canadian Member of Grant Thornton International Ltd



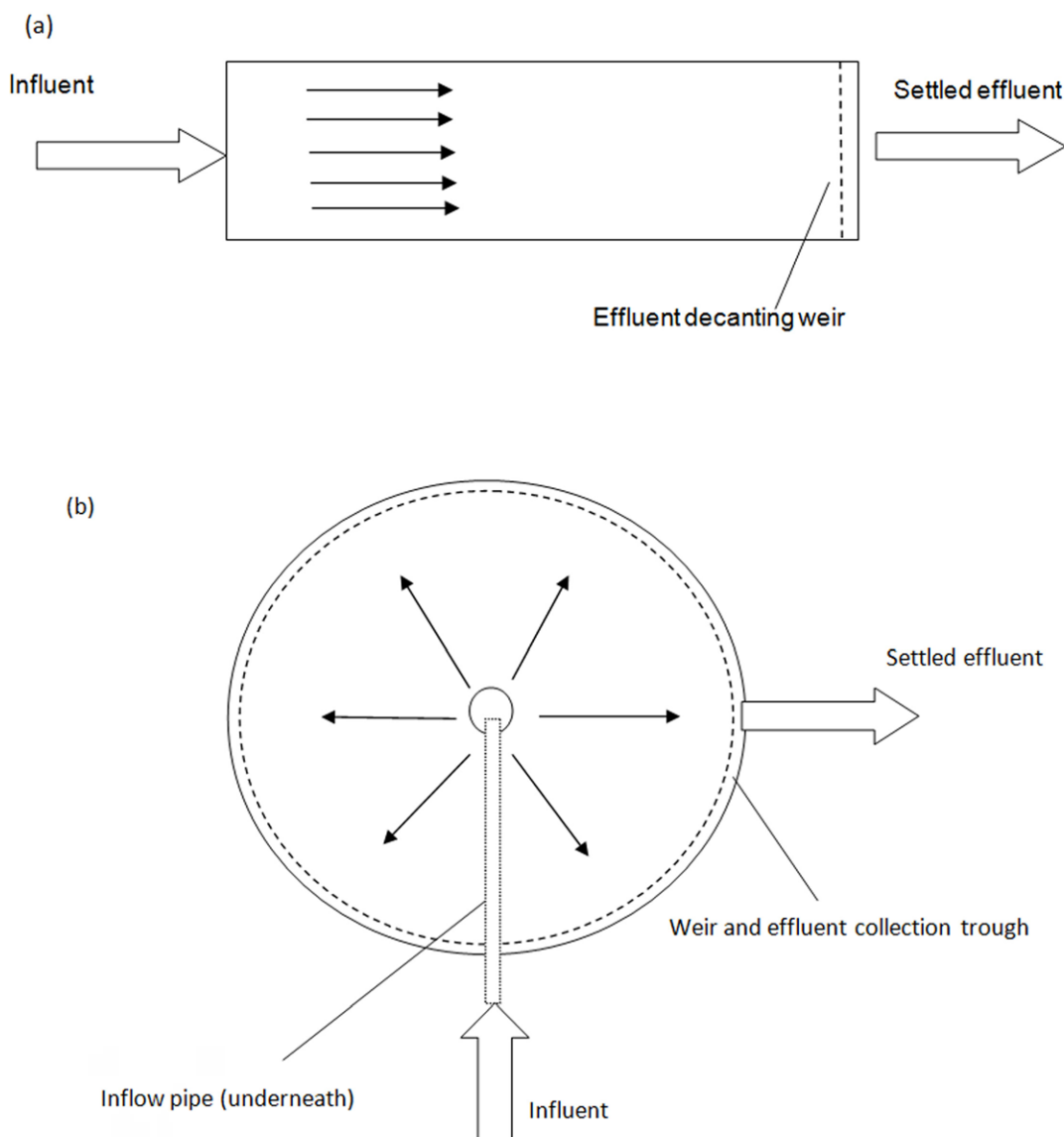

Figure 4.13. Plan view of (a) horizontal flow and (b) radial flow clarifier designs.

Another common sedimentation design type is the upflow clarifier (Figure 4.14). Both flocculation and sedimentation occur in this type of tank. Water enters the tank near the bottom and leaves at the top. Water moves upwards at a rate equal to the overflow rate (v_o), therefore any particle with settling velocity greater than v_o is removed (as with other sedimentation types), but particles with settling velocities less than v_o are not removed and wash out from the top (versus a fraction of these particles being removed in the other types of sedimentation tanks, as described in section 4.3). Therefore, even though upflow clarifiers encourage some flocculation of solids and hence the creation of faster-settling particles, the upwards direction of flow means that upflow clarifiers are less effective than other types of sedimentation tanks, all else being equal. The practical trade-off is that upflow clarifiers are typically quite simple to construct and operate relative to horizontal flow and radial flow tanks.

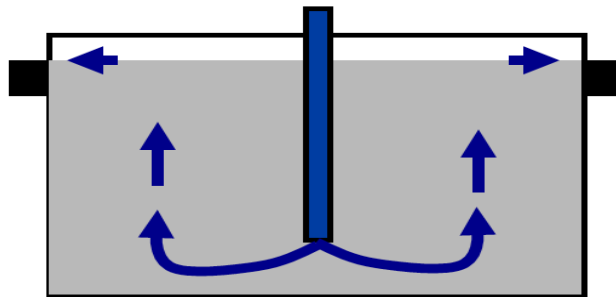

Figure 4.14. Flow in an upflow clarifier.

A sludge blanket upflow clarifier is a variation of an upflow clarifier in which the incoming water flows upwards through a layer of suspended sludge floc, referred to as a sludge blanket. The blanket is maintained at a suspended depth of approximately the mid-depth of the tank. The passage of the incoming water through the suspended sludge enhances particle removal by flocculation. The sludge blanket layer is maintained by having a floc blanket bleed pipe to remove solids from the blanket layer periodically and maintain a consistent layer size and position in the tank. Sludge blanket clarifiers can be more difficult to operate consistently when compared with simple upflow clarifiers or conventional sedimentation tanks.

The various sedimentation tank design types are compared in Table 4.1. Rectangular tanks may be the least costly, especially if adjacent tanks share the same walls. Typical suspended solids removal efficiencies of sedimentation processes are 40-75%, depending on the suspended solids concentration and the overflow rate (Figure 4.15). Typically 20-50% BOD removal is achieved by sedimentation processes, although no soluble BOD is removed, so in practice it is difficult to achieve much higher BOD removal values.

Table 4.1. Comparison of sedimentation tank design types.

Criteria	Horizontal	Radial	Upflow
Space	Low	High	Low
Overflow rate ($m^3/m^2 \cdot d$)	30	<45	30
Detention time (hrs)	2	2	2-3
SS removal (%)	40-75	50-75	65
Sludge (%)	3-7	3-7	3-4
Application	1 ^o and 2 ^o sed.	1 ^o and 2 ^o sed.	Small works

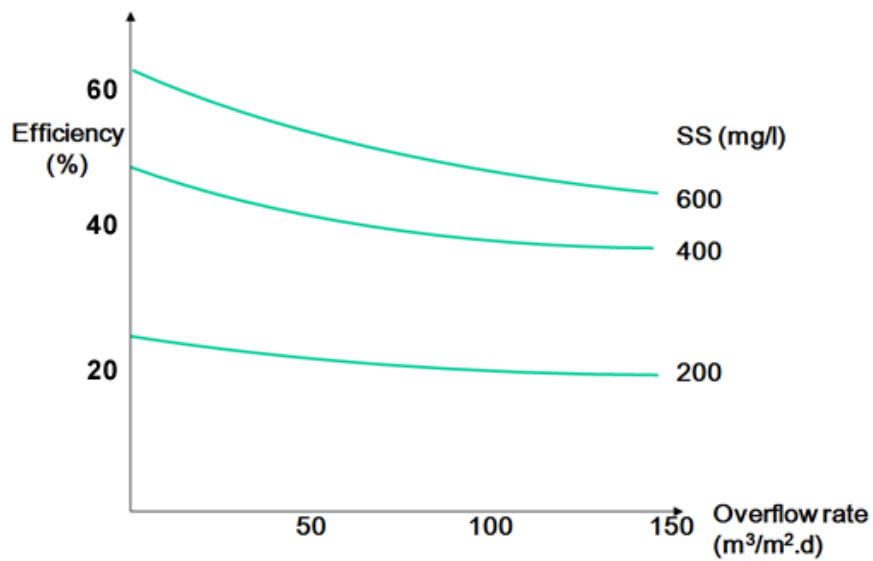

Figure 4.15. Suspended solids percent removal by conventional sedimentation tanks.

4.6 Other Solids Removal Processes

Other solids removal processes, besides conventional sedimentation tanks, include lamella plate settlers, dissolved air flotation, and membrane bioreactors.

4.6.1 Lamella Plate Settlers

Lamella plate settlers are also called ‘high rate’ settlers or ‘parallel plate’ settlers. In this process there are plates inclined at a 45 to 60 degree to the horizontal which act to remove the solids (Figure 4.16). The plates are typically 50 to 200 mm apart. Water enters horizontally and is turned upwards. Settled solids shear off and fall back down the plates to a collection point below, although sometimes flushing or spraying of plates may be necessary.

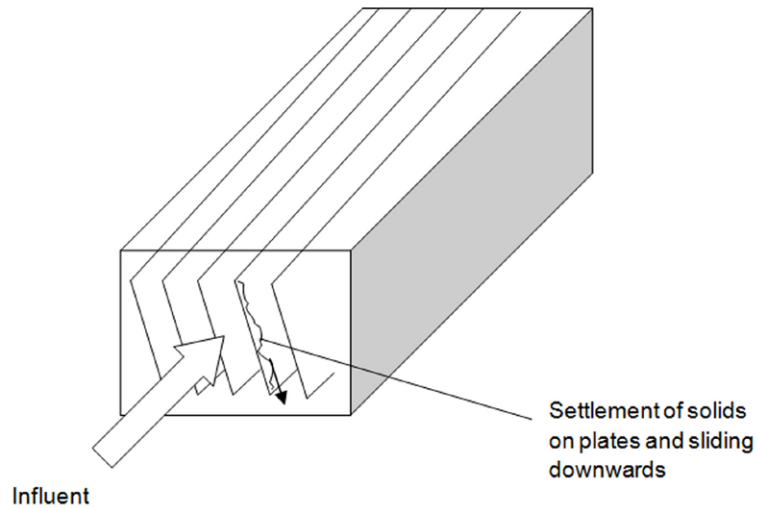

Figure 4.16. Schematic representation of lamella plate settlers in a horizontal flow clarifier.

SIEMENS

RESPONSIBILITY

CREATIVITY

INQUISITIVENESS

OPENNESS

INNOVATION

INGENUITY

COMMITMENT

CAREER DEVELOPMENT

OPPORTUNITY

DECISIVENESS

GLOBAL PERSPECTIVE

WORK-LIFE BALANCE

If it really matters, make it happen – with a career at Siemens.

[siemens.com/careers](https://www.siemens.com/careers)



Removal efficiencies are close to theoretical removal efficiencies for sedimentation tanks but at loading rates that are 2-3 times the conventional rates.

The major advantage of lamella plate settlers is that it can allow the surface area to be much smaller than conventional sedimentation – e.g. a 75% reduction.

All particles with settling velocities greater than the overflow rate are removed (as before), and all other particles are removed according to:

$$\%R \propto N \times v_s / (v_o - v_s) \times 100\%$$

where %R is the percent removal and N is the number of plates in a vertical cross-section. The percent removal increases as the number of plates increases. In practice N ranges from 3 to 10.

There are also tube settlers which use tubes rather than flat plates.

4.6.2 Dissolved Air Flotation

Dissolved air flotation (DAF) involves bubbling fine air bubbles into a tank from the bottom, such that the bubbles rise to the surface and attach to solid particles as they move upwards. A small side-stream of water is aerated to saturation under high pressure and then introduced into the main flow, whereby the pressure drops and the air comes out of solution. DAF bubbles are typically 10 to 100 microns in diameter. A skimmer then removes the sludge from the surface of the water and the clean water leaves through collection pipes near the bottom of the tank. DAF is especially good at removing particles which would be otherwise difficult to settle, such as those with a density close to that of water, and is also useful for thickening biological sludges.

4.6.3 Membrane Bioreactors

In membrane bioreactors, sludge separation is carried out using a membrane filtration unit and no sedimentation tank is required. This is typically configured as either side-stream or submerged. In the side-stream configuration, the membrane filter is external to the aeration tank and the MLSS is pumped through the membrane under pressure; the permeate is discharged and the retentate is either returned to the aeration tank or wasted. In the submerged configuration, the membrane is inside the aeration tank and the necessary trans-membrane pressure is generated by a suction pump and/or using the hydraulic head within the tank.

The advantages of membrane bioreactors include:

- High biomass concentration, allowing high loading rates and small footprints
- High sludge age, low sludge production
- Very high quality effluent produced; virtually all solids and pathogens are removed.

Disadvantages of membrane bioreactors include:

- High running costs (e.g. energy to maintain the trans-membrane pressure)
- High membrane capital costs
- Membrane fouling.

5 Biological Treatment

The aim of biological treatment is to transfer dissolved organic contaminants (e.g. BOD) from a soluble form into suspended matter in the form of cell biomass, which can then be subsequently removed by particle-separation processes (e.g. sedimentation).

The most effective biological processes for removing dissolved organics in this way are aerobic processes, since they are fastest and their products are relatively inoffensive (H_2O , CO_2). Typically oxygen must be added to the wastewater to support the aerobic process, either through bubbling air into the water or through mixing.

Conceptually, the aerobic process can be simplified as:



The key design questions in a biological treatment process therefore are: How long will it take the process to reduce the BOD to below the target concentration? How much oxygen must be added? How much residual cell biomass (i.e. 'sludge') will be produced?

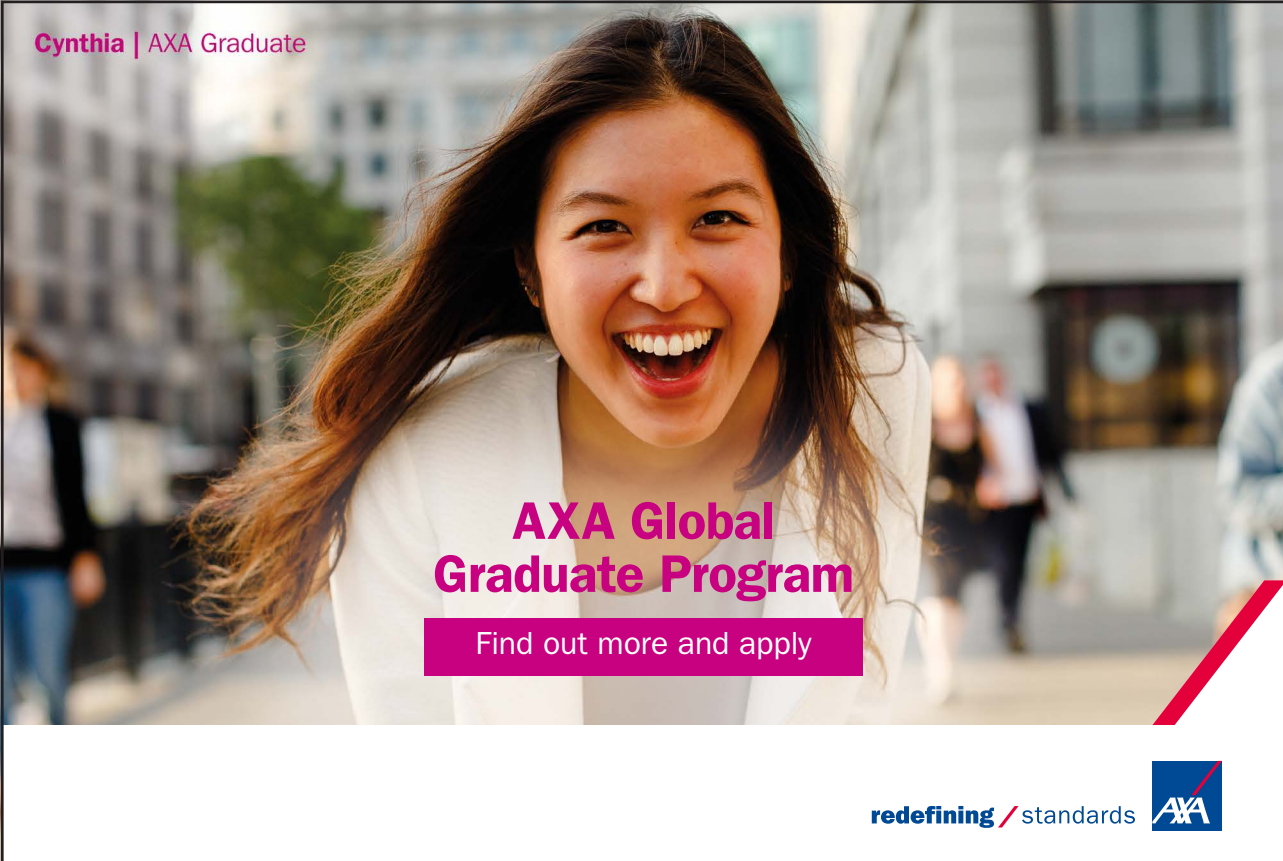

Cynthia | AXA Graduate

AXA Global Graduate Program

Find out more and apply

redefining / standards AXA



Biological treatment processes can be classified as either 'suspended growth' processes, wherein the bacterial cells are suspended in the water column in a tank, or 'attached growth' (also called 'fixed film') processes, wherein the cells are attached onto a surface as a biofilm and the water is passed over the surface. Suspended growth biological treatment is commonly referred to as 'activated sludge', whereas attached growth process can take various forms, including trickling filters and rotating biological contactors.

5.1 Biological Growth Kinetics

For the design and operation of both suspended growth and attached growth biological treatment processes it is important to understand the underlying biological growth kinetics.

The biological growth cycle can be conceived in terms of four phases (Figure 5.1). Consider a bacterial population enclosed in a bottle with a fixed amount of food. Initially it takes some time for the bacteria to acclimatise to their environment before beginning to reproduce; this is the lag phase. While there is still an excess of food, the cells reproduce exponentially and are only limited by their inherent rate of reproduction; this is the log growth phase. When food eventually becomes limiting, the rate of growth equals the rate of death; this is the stationary growth phase. Finally, when there is a shortage of food, the bacteria consume each other for food (known as endogenous growth); this is the log death phase.

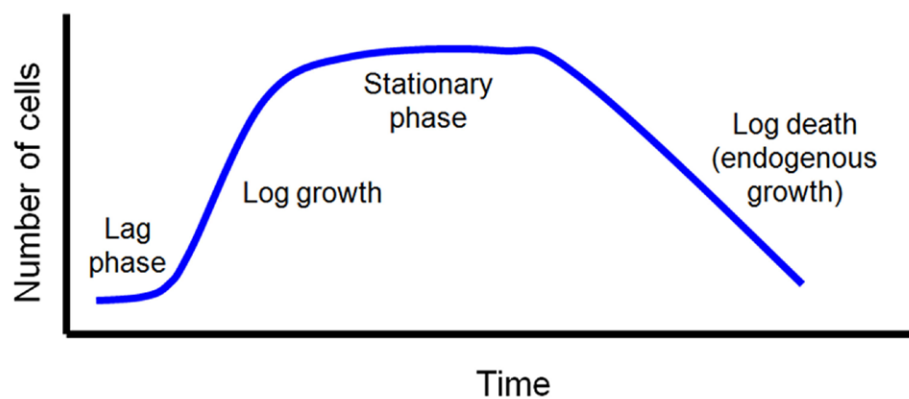

Figure 5.1. The biological growth cycle.

In a biological treatment process in wastewater treatment at any given time there will be a mixture of bacterial populations competing with one another and existing at different phases of this cycle.

The relationship between cell biomass and substrate (food) in the different phases is summarised in Figure 5.2.

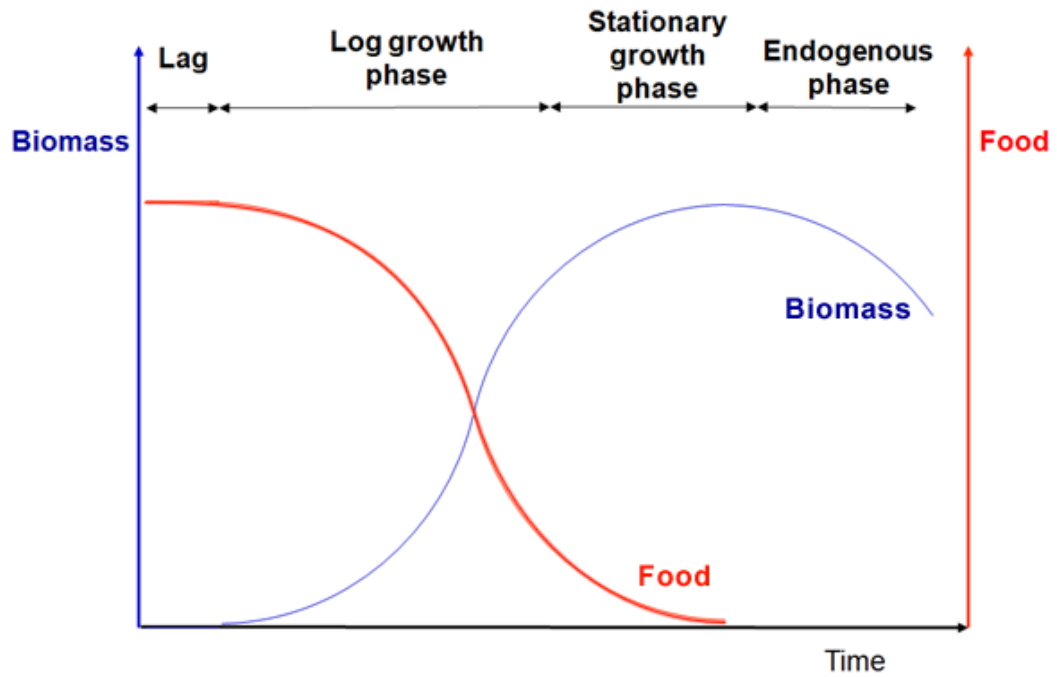

Figure 5.2. Biomass and food during the different stages of the biological growth cycle.

The growth rate in the log growth phase can be expressed as:

$$dX / dt = \mu \times X$$

where X = concentration of biomass (mg/l) and μ is the specific growth rate (rate of growth per unit biomass, units of days⁻¹).

Monod studied the declining growth phase (i.e. substrate-limited growth) in batch cultures of bacteria. He observed that growth is a function of the microorganism and substrate concentrations and proposed a relationship between the residual concentration of the growth-limiting substrate and the specific growth rate of the biomass (Figure 5.3).

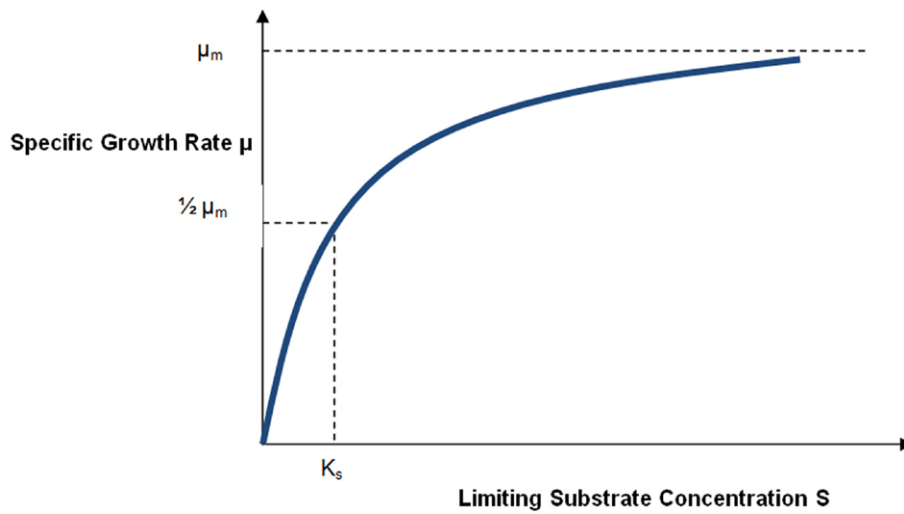

Figure 5.3. Monod growth curve.

This can be expressed mathematically as:

$$\mu = \mu_m \times S / (K_s + S)$$



Scholarships



Lnu.se

Open your mind to new opportunities

With 31,000 students, Linnaeus University is one of the larger universities in Sweden. We are a modern university, known for our strong international profile. Every year more than 1,600 international students from all over the world choose to enjoy the friendly atmosphere and active student life at Linnaeus University. Welcome to join us!

Linnæus University

Sweden

Bachelor programmes in
Business & Economics | Computer Science/IT | Design | Mathematics

Master programmes in
Business & Economics | Behavioural Sciences | Computer Science/IT | Cultural Studies & Social Sciences | Design | Mathematics | Natural Sciences | Technology & Engineering

Summer Academy courses



where μ_m = maximum specific growth rate (d^{-1}), S = concentration of substrate (mg/l, as BOD or COD), and K_s is the saturation constant (units of mg/l, equal to the limiting substrate concentration at half the maximum growth rate).

Substituting this expression into the earlier equation for dX/dt yields the following equation for the biomass growth rate in a substrate-limiting solution:

$$dX / dt = \mu_m \times X \times S / (K_s + S)$$

In practice, not all the substrate is metabolised to biomass, as some is converted to waste products. The growth yield (Y) is defined as the amount of biomass produced per unit of substrate utilised:

$$dX / dt = Y \times dS / dt$$

Typical values for Y for aerobic processes are 0.4-0.8, versus 0.08-0.2 for anaerobic processes.

Substituting the earlier equation for dX / dt into this yield equation and re-arranging leads to the following equation for the rate of substrate utilisation when biomass growth is limited by the substrate:

$$dS / dt = (-\mu_m/Y) \times (X \times S) / (K_s + S) = k \times (X \times S) / (K_s + S)$$

where k combines the constants μ_m and Y .

Another commonly used parameter is the specific substrate utilisation rate, U , which is the rate of substrate utilised per unit of biomass:

$$U = (dS / dt) / X$$

The rate of biomass decrease in the endogenous phase can be expressed as:

$$dX / dt = -k_d \times X$$

where k_d is a microbial decay coefficient with units of $days^{-1}$.

Therefore, by combining equations for the different growth phases, the overall equation for the rate of biomass growth is:

$$dX / dt = \mu_m \times X \times S / (K_s + S) - k_d \times X$$

By re-arranging and setting $t = \theta$ (the mean hydraulic retention time), the following two useful expressions for reactor biomass concentration (X) and effluent substrate concentration (S) can be derived:

$$X = Y \times (S_0 - S) / (1 + k_d \times \theta)$$

$$S = K_s \times (1 + k_d \times \theta) / [\theta \times (\mu_m - k_d) - 1]$$

The growth kinetics of biomass is therefore described by five main kinetic parameters: Y , k_d , K_s , k , and μ_m . These are obtained from experiments or measurements and depend on the type of wastewater and substrate (Table 5.1).

Also, k_d , k , and μ_m are a function of temperature:

$$k_T = k_0 \times \Phi^{(T-20)}$$

where T = temperature (degrees Celsius), k_T = reaction rate constant at temperature T , k_0 = reaction rate constant at 20 degrees Celsius, and Φ is a temperature-activity coefficient (typical values are 1.00-1.03 for activated sludge processes, or 1.02-1.04 for biological filters). This temperature-dependence is mainly because temperature affects microbial metabolism rates and the oxygen transfer rate.

Table 5.1. Typical microbial rate constants for different wastewater types.

Wastewater	k (d ⁻¹)	K (mg/l)	k _d (d ⁻¹)	Y (-)	S (type)
AEROBIC					
Domestic sewage	5.6	22	0.07	0.67	COD
Dairy waste	5.1	100	0.05	0.48	BOD
Glucose	2.9	355	0.09	0.42	BOD
Fish plant	36	85	1.6	0.5	BOD
ANAEROBIC					
Dairy waste	0.38	24	0.07	-	COD
Acetic acid	3.6	2,130	0.02	0.04	COD
Landfill leachate	2.9	1,670	0.02	0.067	-

5.2 Activated Sludge

The activated sludge process consists of a high concentration (2,000-8,000 mg/l) of microorganisms (mainly bacteria, but also protozoa and fungi) present as floc and kept in suspension by agitation, with the aim of removing organic matter from the wastewater. The main processes in the removal of the organic material are adsorption, carbonaceous oxidation, and nitrification (Figures 5.4), with oxygen consumed and carbon dioxide produced during the assimilative and endogenous respiration phases of the microbial growth cycle (Figure 5.5).

The key components of an activated sludge process (Figure 5.6) are:

1. A reactor bringing the waste in contact with the microorganisms (often called an 'aeration tank')
2. A means of transferring oxygen to the microorganisms
3. A means of agitating the suspension
4. A system for separating the microorganisms from the treated water
5. A system for recycling some of the microorganisms back to the reactor
6. A system for wasting microorganisms (as 'sludge').

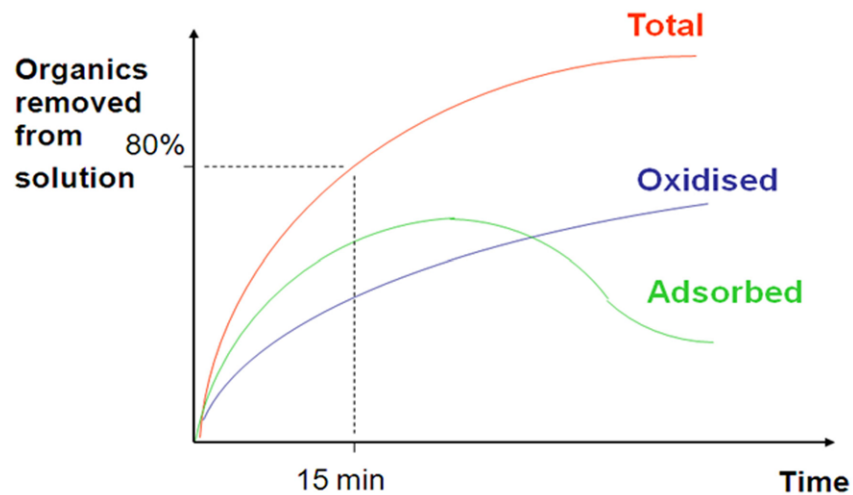

Figure 5.4. Removal of organics in an activated sludge process.

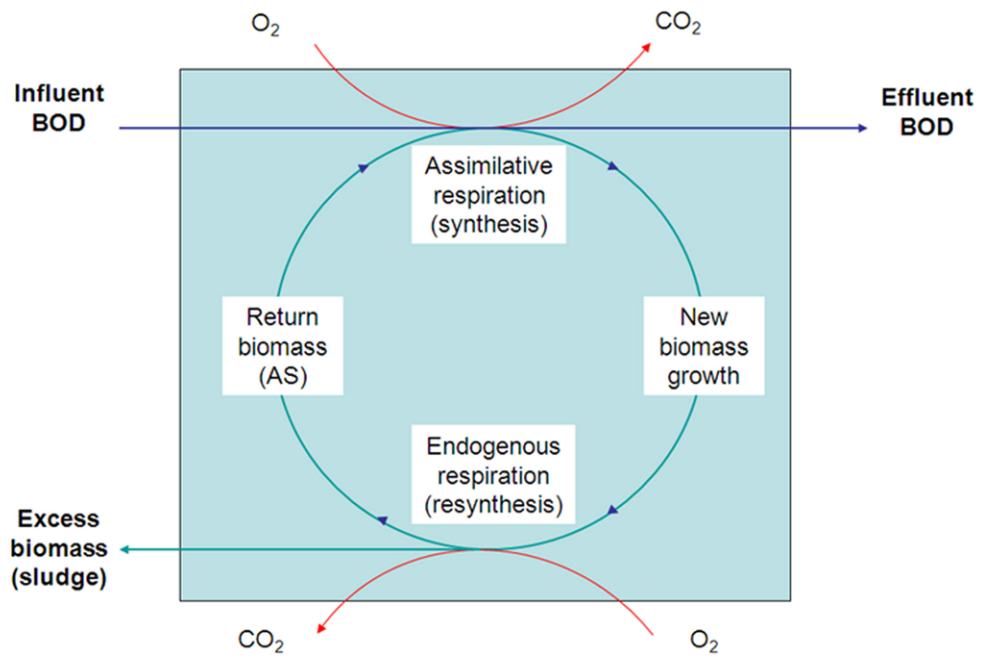

Figure 5.5. Biomass synthesis cycle for a biological treatment process.

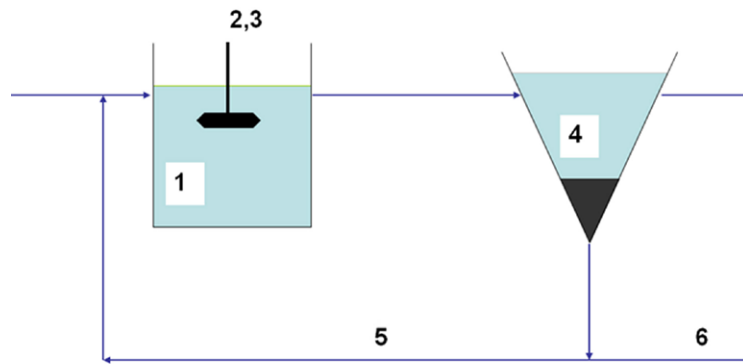

Figure 5.6. The key components of an activated sludge process.

The concentration of biological cells in an activated sludge reactor is expressed in units of mg/l of mixed liquor suspended solids (MLSS), i.e. referring to the agitated biomass in suspension in the reactor. Mixed liquor volatile suspended solids (MLVSS) is also commonly used and is a slightly more accurate representation of the biomass concentration than MLSS, by counting only the organic solids in the reactor (i.e. since cells are mostly organic versus inorganic).

For design, the capacity of an activated sludge reactor is determined on the basis of achieving a suitable food-to-microorganism (F/M) ratio. F/M represents the relative availability of substrate (i.e. food) for the active microorganisms and can be calculated as:

$$F/M = (Q \times S_0) / (V \times X)$$

where Q is the flow rate (m³/day), S₀ is the BOD concentration of the inflow (kg/m³ as BOD), V is the reactor volume (m³), and X is the biomass concentration in the reactor (kg/m³ as MLSS). The units of F/ M ratio are therefore kg BOD per kg MLSS per day.

An F/M ratio of between 0.2-0.5 kg BOD per kg MLSS per day is typically targeted, which keeps the activated sludge bacteria slightly 'hungry' and results in optimal settling characteristics of the resulting sludge (Figure 5.7).

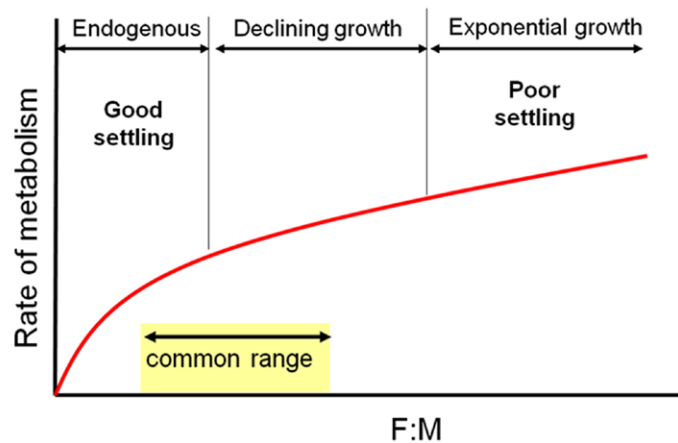

Figure 5.7. The impact of food-to-microorganism ratio on sludge settling characteristics.

Another key design criteria for the activated sludge process is the sludge age (θ_c), which represents the average length of time that biological cells are in the aeration tank and can be expressed mathematically as:

$$\theta_c = \text{total cell mass} / \text{cell removal rate} = X / (dX/dt)$$

The sludge age is typically on the order of 5-10 days and sometimes longer if nitrification is desired.

Other commonly used parameters to characterise activated sludge process performance are:

$$\text{Organic loading rate} = (Q \times S_0) / V \text{ (units of kg BOD per m}^3 \text{ per day)}$$

$$\text{Hydraulic loading rate} = Q / A_s \text{ (units of m}^3 \text{ per m}^2 \text{ per day)}$$

where A_s is the floor area of the reactor.

The most common reactor type for an activated sludge process is conventional plug flow, with baffling to extend the contact time and prevent hydraulic short-circuiting. A high substrate concentration at the inlet means a faster substrate utilisation rate at that point and then endogenous decay occurs near the effluent, leading to good settling sludge. A variation on the conventional plug flow reactor is tapered aeration (Figure 5.8), whereby more oxygen is applied at the front than at the rear, leading to a more efficient usage of the oxygen (i.e. more biological activity in the place where the substrate concentration is highest).

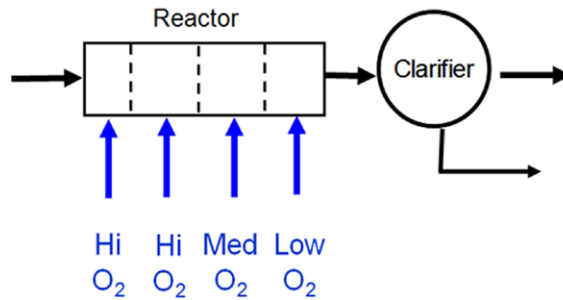

Figure 5.8. A plug flow activated sludge reactor with tapered aeration.

I'M WITH ZF.
ENGINEER AND EASY RIDER.

www.im-with-zf.com

ZF MOTION AND MOBILITY

100 YEARS MOTION AND MOBILITY

Scan the code and find out more about me and what I do at ZF:

CHARLES JENKINS
Quality Engineer
ZF Friedrichshafen AG



Another common type of activated sludge process is extended aeration, whereby there is a very long hydraulic retention time (e.g. > 24 hours) and a very high sludge age. The low F/M and slow flows lead to conditions which maintain the bacteria in an endogenous respiration phase, leading to high quality settling sludge. Extended aeration systems also tend to be more robust against variable flows, due to the long average hydraulic retention times. The drawback of this option is the large tank size required.

There are in fact many different variations for activated sludge processes and these can be considered for design purposes in terms of the idealised system shown below (Figure 5.9), as a completely mixed reactor with recycle from the secondary clarifier.

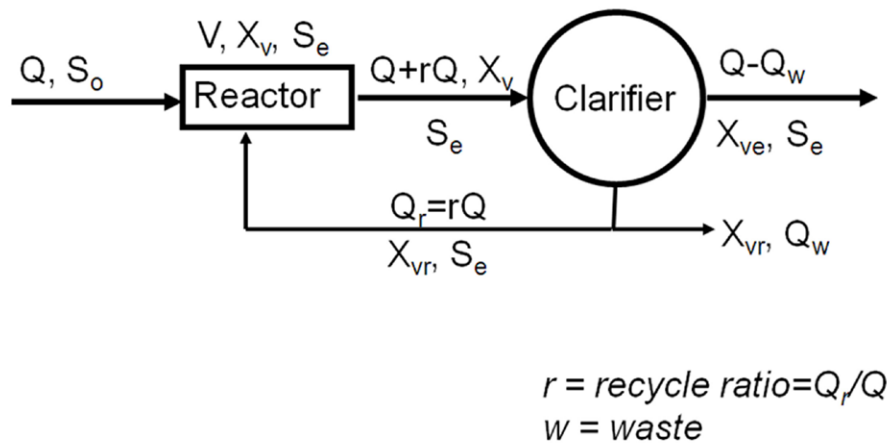

Figure 5.9. Activated sludge process with recycled sludge from the secondary clarifier. X_v refers to the biomass measured in terms of MLVSS (i.e. v = volatile).

The recycle ratio is typically a value of 0.25-0.50 and is a crucial process operating variable, since recycling too little sludge will cause the MLSS in the reactor to drop and hence negatively impact the BOD removal performance, while returning too much sludge will increase the MLSS and eventually result in poor settling sludge. The recycled activated sludge is often referred to as ‘RAS’ and the waste activated sludge as ‘WAS’.

Starting from the definition of sludge age given above and conducting a mass balance on biomass, the sludge age in such a system can be shown to be equal to:

$$\theta_c = (V \times X_v) / [Q_w \times X_{vr} + (Q - Q_w) \times X_{ve}]$$

The sludge age can also be expressed in terms of the microbial growth kinetics as discussed in section 5.1, as:

$$\theta_c = Y \times U - k_d$$

The biomass concentration can be calculated as:

$$X = (\theta_c / \theta) \times [Y \times (S_0 - S_e) / (1 + k_d \times \theta_c)]$$

The substrate concentration can be calculated using:

$$(S_0 - S_e) / \theta = (k \times V \times S_e) / (K + S_e)$$

where Y, K, k_d , and k are the coefficients that are specific to the specific activated sludge microbial community consuming the specific wastewater in question (Table 5.1)

The rate of sludge production (P_x) can be calculated as:

$$P_x = [Y \times Q \times (S_0 - S_e)] / (1 + \theta_c \times k_d)$$

Sludge production rate is normally expressed in units of kg per day.

Sufficient air must be transferred to the mixed liquor to maintain a dissolved oxygen level of at least 1-2 mg/l (higher if nitrification takes place in the same reactor). Common aeration equipment include diffusers, which bubble air or pure oxygen from nozzles in the aeration tank floor and up through the mixed liquor, or mechanical agitators, such as rotating paddles.

The oxygen required for an activated sludge process can be calculated as:

$$O_2 = 1.47 \times Q \times (S_0 - S_e) - 1.42 \times P_x$$

Oxygen mass transfer rate is normally expressed in units of kilograms per day. The 1.42 is the mass of oxygen (grams) required to oxidise 1 gram of a theoretical bacterial cell.

Bubbling pure oxygen into aeration tanks instead of air can increase the oxygen transfer efficiency by a factor of four, which allows for smaller tanks and yields better sludge characteristics and better nitrification performance. The main disadvantage is the capital and operating cost associated with the pure oxygen supply. The pure oxygen process option is commonly used for treating high strength wastes or for upgrading overloaded treatment works.

5.3 Attached Growth Processes

Attached growth biological treatment processes involve similar BOD removal and nitrification processes as in activated sludge except that the cells are attached onto a solid surface as a biofilm over which the wastewater is passed (Figure 5.10). Types of attached growth processes include trickling filters (sometimes called biological filters), rotating biological contactors, and submerged aerated biological filters.

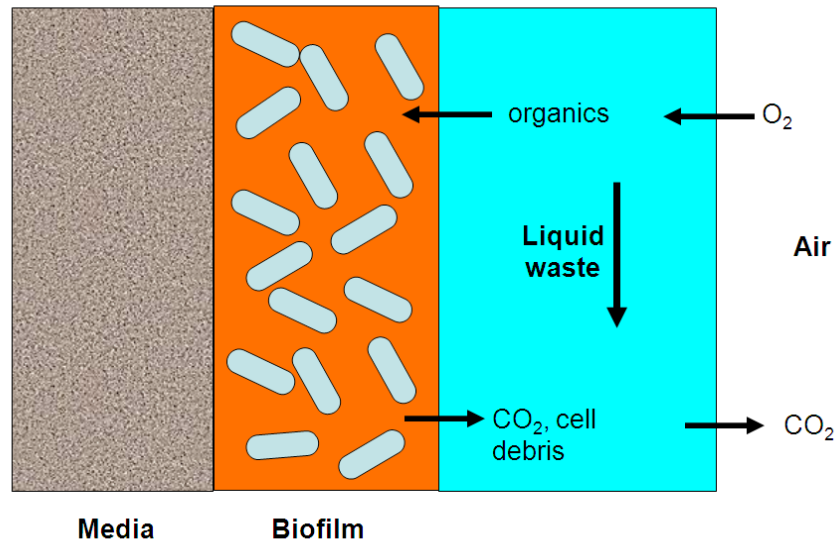

Figure 5.10. Removal of organics by a biofilm.

5.3.1 Trickling Filters

The key components of a trickling filter (Figure 5.11) are:

Are you ready to do what matters when it comes to Technology?

Deloitte.

The advertisement features a word cloud on a black background. The most prominent words include: CRM, Enterprise Content Management, SQL, End-to-End Solution, Cyber Crime Innovation, Technology Advisory, Information Management, Java, Cloud Computing, SAP, Enterprise Application, Social Business, IT Consultancy, Big Data, Implementation, Web-enabled Applications, Data Analytics, Enterprise Application, Social Business, IT Consultancy, .NET Implementation, and Cloud Computing.



1. A dosing system for applying the wastewater
2. A bed of randomly packed solid media
3. An underdrainage system for collection of the treated effluent
4. A ventilation system for supplying oxygen to the filter
5. A system for separating the detached biofilm (also called humus) from the treated effluent.

Wastewater is spread on the media surface and trickles down through the media on which the biofilm is attached. The biological activity of the biofilm is the primary mechanism of removal of dissolved organic matter, more so than filtration / attachment onto the media surface. BOD stabilisation occurs at the film / wastewater interface with a fairly short contact time (20-30 seconds). The process works due to the large surface area of the biofilm on the media surfaces.

Because the organisms remain in place attached to the media surfaces, very long sludge ages and high cell masses can be achieved. Conditions in trickling filters are mainly aerobic and the microbial community includes a mixture of bacteria, protozoa, and fungi. The biofilm organisms are attached to the surface and protected by a coating of extracellular polysaccharides (EPS), leading to a very robust, hardy film that can tolerate changing conditions quite well. The biofilm layer is microscopic in thickness (i.e. $\ll 1\text{mm}$).

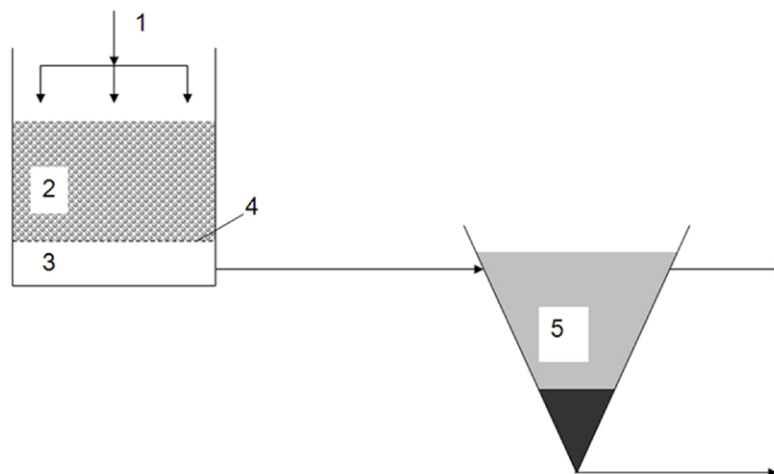

Figure 5.11. The key components of a trickling filter process.

Biofilm growth is outwards from the media surface, eventually leading to 'sloughing', due to endogenous decay and anaerobic conditions at the biofilm/media interface. Attachment weakens and the film shears off; the biofilm quickly re-establishes, however. The sloughed biofilm is referred to as 'humus'. The humus is removed from the treated effluent by a clarifier downstream. Humus normally settles well and is often re-circulated to the primary clarifier to serve as a settling aid.

The regular sloughing of the biofilm results in an effluent that is low in BOD but high in SS, therefore the design and operation of the secondary clarifier is critical. Higher loading rates can be used for the secondary clarifier than in activated sludge treatment due to the good settling characteristics of the humus.

Modern trickling filters use synthetic media which are specially designed to have large surface area and porosity and typically made of plastic. Traditional media include crushed stone, typically with 25-100 mm diameter and a maximum 2 m bed depth. Other media include rock, slag, and redwood.

The filter is not submerged, so as to encourage aerobic conditions. Oxygen in the wastewater and air supplied through ventilation allow aerobic conditions to be maintained.

The rate of wastewater application must be controlled to avoid flooding the filter bed. The concentration of influent substrate must also be well understood in order to avoid too much biological growth and hence plugging of the filter. It is also important to avoid freezing of the filter in winter in cold climates.

A conventional trickling filter plant can achieve a 20:30 effluent (i.e. < 20 mg/l of BOD, < 30 mg/l of SS) at the organic loading rates between 0.06-0.12 kg BOD per m³ per day or hydraulic loading rates of 0.25-1.2 m³ per m² per day.

Due to the complexity of the microbial community in trickling filters and the difficulty in representing the rate of biofilm sloughing, the design of trickling filters uses empirical relationships based on previous experience, such as the following equation:

$$S_e = S_i \times \exp [(-kAD) / (Q_t)^n]$$

where S_e is the effluent BOD, S_i is the influent BOD, k is a rate constant for substrate utilisation, D is the depth of the filter, A is specific surface area of the filter, Q_t is the hydraulic loading rate, and n is an experimentally derived coefficient.

The flow distributors are typically rotating perforated arms through which the wastewater is distributed evenly over the filter surface. They are normally designed to be self-propelled by the thrust of the water jetting out of the arm. The perforations in the rotating arm are larger on the outer parts of the arm due to the larger surface area being covered at further radii out from the centre of the filter. A common problem is sedimentation of particles and/or biofilm growth within the distributor arm.

Drainage is accomplished by supporting the media on a pervious suspended floor over an impervious base, graded to a collecting channel underneath. The drainage channel should be sized for the maximum expected flow rate and should allow free air flow.

Ventilation is achieved by natural air circulation, induced by a heating effect by the wastewater itself. In temperate climates ventilation can be achieved by providing inlets around the base of the filter wall.

The advantages of trickling filters are:

- Generally able to meet a 20:30 effluent standard, with nitrification at lower rates
- No / low power requirements
- Relatively simple operation
- Quiet and does not foam

- Quicker recovery to changes in influent BOD and flow (compared to activated sludge)
- Easier secondary clarifier design due to good settling of humus.

The disadvantages of trickling filters include:

- Higher space requirements than activated sludge
- Possible fly and odour problems
- Possibly clogging problems.

5.3.2 Rotating Biological Contactors

Rotating biological contactors (RBCs) are another type of attached growth process, consisting of a series of closely packed plastic discs of a shaft, rotating and partially submerged in wastewater. RBCs use the same principles as a trickling filter except now the media rotates and the wastewater is stationary.

Rotation of the discs allows alternating contact of the biological film on the disc with the organic matter in the wastewater and then with the oxygen in the air, thereby maintaining aerobic conditions. The rotation of the discs also removes excess solids by shearing and maintains the sloughed material in suspension for removal in a downstream clarifier.

RBCs are a more intensified process than trickling filters, with higher concentrations of organisms in the biofilm (e.g. 50,000 mg MLSS per litre, or 200 g / m²). RBCs can easily achieve a 20:30 effluent, with typically greater than 90% removal of BOD.

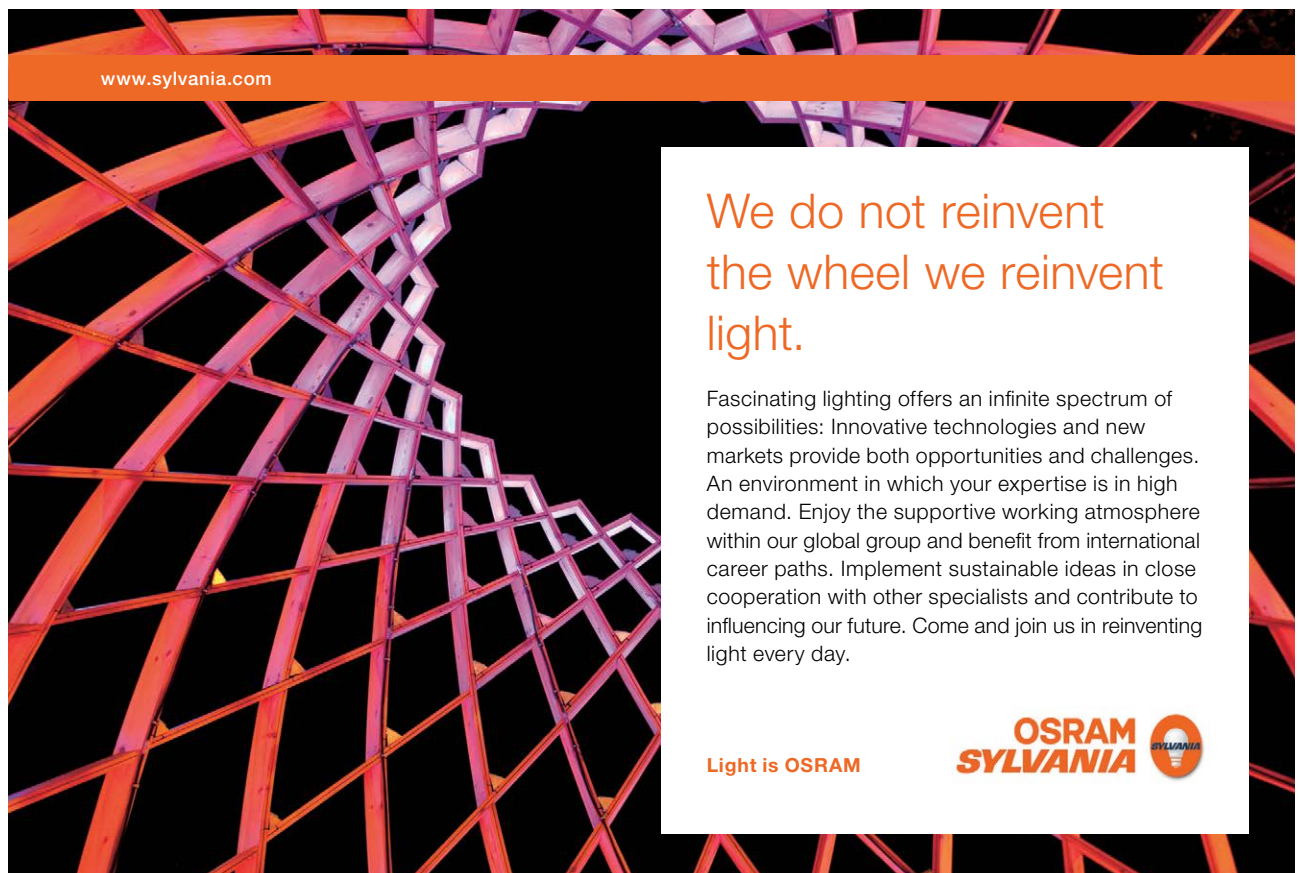

www.sylvania.com

We do not reinvent
the wheel we reinvent
light.

Fascinating lighting offers an infinite spectrum of possibilities: Innovative technologies and new markets provide both opportunities and challenges. An environment in which your expertise is in high demand. Enjoy the supportive working atmosphere within our global group and benefit from international career paths. Implement sustainable ideas in close cooperation with other specialists and contribute to influencing our future. Come and join us in reinventing light every day.

Light is OSRAM

OSRAM
SYLVANIA



The discs are made of wood, metal or plastic. They are typically up to 4 m in diameter and rotate on a shaft up to 7 m long at a rotational speed of 1-2 rotations per minute, with 40% of the discs immersed in wastewater.

As with trickling filters, the design of RBCs is based largely on empirical relationships. The key design variables are the media design, the speed of the drive shaft, the trough volume below the discs, and the depth of immersion. A typical loading rate is 3-8 g of BOD per m² per day, although high rate variations can treat 20+ g of BOD per m² per day.

Primary sedimentation is critical to RBC operation, to avoid excessive amounts of larger solids settling between the discs and impeding their rotation. Secondary sedimentation is equally important to remove the high concentrations of sloughed biomass from the treated effluent.

RBCs can also operate in nitrification / denitrification modes by tailoring the disc immersion ratio and rotational speed.

The advantages of RBCs include:

- Compact size (small land requirement compared to equivalent treatment by trickling filters)
- Ease of operation
- Low power consumption relative to activated sludge (no need for aeration)
- Usually no need to recycle the sludge.

The disadvantages of RBCs include:

- Must protect from weather (heat, cold, intense sunlight)
- High capital cost
- Potential for mechanical failures.

5.3.3 Submerged Aerated Biological Filters

Submerged aerated biological filters (SBAFs) are another type of attached growth biological treatment process. They consist of a submerged, packed bed of granular media. Air is blown up through the filter as wastewater flows downwards through the filter. When the filter becomes blocked, cleaning is by upflow backwashing, with the backwash returned to the works inlet and the process continuing. Some wastewater treatment works have tertiary sand filters as a final polishing step, in which case the SBAF backwash can be set to coincide with the sand filter backwash cycle.

The large wetted surface area of the media and high dissolved oxygen levels allow rapid growth of biomass and hence an intensive process. A typical organic loading rate would be between 1.2-2.5 kg BOD per m³ of media per day, i.e. an order of magnitude higher than trickling filters.

The advantages of SBAFs include:

- Small reactor volume
- No secondary sedimentation.

The disadvantages of SBAFs include:

- Backwash to handle
- SS removal performance is not as good after backwash
- Need to provide aeration.

5.4 Sludge Volume Index

The secondary clarifier following biological treatment must perform two functions:

- Separation of MLSS from the treated effluent
- Thickening of sludge for subsequent recycling or wasting.

The operation of the tank depends on how easily the activated sludge biomass settles, which is a property of the sludge and conditions in the reactor. A parameter to quantify sludge settleability is the sludge volume index (SVI).

SVI is the volume of sludge occupied by a unit mass of MLSS after settlement:

$$\text{SVI} = \text{sludge volume (ml/l)} \times 1000 / \text{MLSS (mg/l)}$$

The units of SVI are ml/g.

The measurement is typically done in a 1 litre graduated cylinder or cone and allowing at least 30 minutes for settling.



For good settleability, SVI should be in the range of 50-150. SVI outside this range indicates poor settling and may require optimisation of the upstream biological treatment process. Specifically, a high SVI may indicate what is called 'sludge bulking', which is the prevalence of slow-settling filamentous bacteria which thrive in difficult growth conditions such as low F/M, low oxygen, low nutrients, low pH, or due to the nature of the organics in the wastewater (e.g. for industrial wastewater effluents with contaminants that are difficult to degrade).

6 Nutrient Removal

In addition to the removal of suspended solids and BOD from wastewater, nutrients such as nitrogen and phosphorus are commonly targeted for removal from wastewater. This is primarily because these nutrients can cause eutrophication of receiving waters if they are not removed from effluents. In addition, nitrogenous organic matter can exert an oxygen demand in the environment if discharged in effluents, thereby contributing to the depletion of dissolved oxygen in receiving waters. There are also toxicity concerns with certain forms of nitrogen (e.g. nitrate, ammonia).

6.1 Nitrification and Denitrification

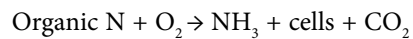
Nitrification is the process of transforming the organic nitrogen in wastewater to nitrate. This is carried out by bacteria known as Nitrosomas. The nitrification process can be represented in a simplified form as:

At Navigant, there is no limit to the impact you can have. As you envision your future and all the wonderful rewards your exceptional talents will bring, we offer this simple guiding principle: It's not what we do. It's how we do it.

Impact matters.

NAVIGANT
navigant.com

DISPUTES & INVESTIGATIONS • ECONOMICS • FINANCIAL ADVISORY • MANAGEMENT CONSULTING

©2013 Navigant Consulting, Inc. All rights reserved. Navigant Consulting is not a certified public accounting firm and does not provide audit, attest, or public accounting services.
See navigant.com/licensing for a complete listing of private investigator licenses.



Nitrifying bacteria are slow growers, energetically inefficient, and subject to environmental constraints. They are autotrophs, using CO_2 as their carbon source for the synthesis of new cells and nitrogen compounds as their energy source. In mixed cultures with heterotrophs (BOD-consumers), they are poor competitors unless organic carbon becomes depleted. The cell yield of nitrifiers is low compared to BOD-consuming heterotrophs and therefore longer sludge ages (at least 7-10 days) are needed when attempting to achieve nitrification.

As suggested by the simplified reactions above, there is a large oxygen requirement for nitrification – 4.2 grams of oxygen per gram of NH_4^+ -N oxidised. Typically at least 2 mg/l of oxygen is needed for nitrification.

Alkalinity drops during nitrification due to the production of acid (H^+) – i.e. 8.6 grams of alkalinity are destroyed per gram of NH_4^+ -N oxidised. The pH of the wastewater can therefore be used as a process monitor and in some cases bicarbonate may be needed to keep the pH within the optimal range (pH 6.5-8) for nitrification to continue to occur.

Nitrification can be achieved in a *single-stage* reactor, wherein the nitrifiers are in the same tank as conventional activated sludge heterotrophic bacteria, or as a *separate-stage* process, wherein the nitrifiers and heterotrophs are kept in separate reactors, allowing optimisation of each process separately.

The single-stage approach has the advantages of less solids wasting (due to long sludge age) and only one clarifier is required. The disadvantages include greater oxygen requirements, secondary clarification operation is more critical, and possible denitrification in the secondary clarifier.

The separate-stage approach has the advantages of optimisation and separate control over the two processes (BOD removal and nitrification), yielding the possibility of overall lower oxygen demand and smaller tank volumes. The disadvantages include more solids-wasting than the single-stage approach and two clarifiers are needed.

In some cases it may be necessary to eliminate the produced nitrate from nitrification to protect the receiving water, in which case denitrification must be used to convert the nitrate to nitrogen gas. This is carried out by bacteria known as Nitrobacter.

Denitrification can be represented in a simplified form as:



Denitrification is an anoxic process – i.e. it does not require molecular oxygen to be present in the water, although oxygen atoms are present within the nitrate.

The denitrification process requires organic carbon, therefore if the denitrification process is placed after BOD removal and nitrification in series, a carbon source may need to be re-introduced into the water in order to achieve denitrification; methanol, acetate, and ethanol are commonly used carbon sources in such cases. A process design option to avoid having to add a carbon source for denitrification is to place the denitrification step before BOD removal and nitrification and recycle a portion of the nitrified water back to the front of the process for denitrification (Figure 6.1).

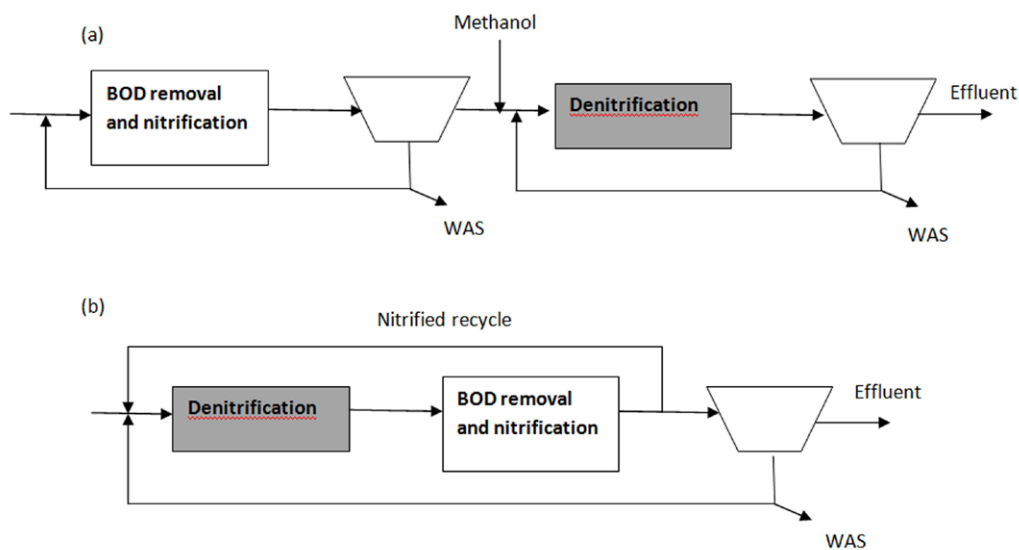

Figure 6.1. Example process flow options for achieving nitrification-denitrification: (a) the addition of methanol as a carbon source for denitrification following BOD removal and nitrification, (b) the recycle of nitrified water for denitrification. The shaded processes indicate anoxic zones while the un-shaded processes indicate aerobic zones.

Nitrification and denitrification can also sometimes be achieved in the same reactor, for example in the case of baffled reactors in which selected aerators are shut off to create distinct anoxic zones where denitrification can take place.

6.2 Phosphorus Removal

Phosphorus is typically present in concentrations of 5-15 mg/l (as total P) in domestic wastewater, 70% of which is in the form of soluble polyphosphate; most of the remainder is in the form of orthophosphate (HPO_4^{2-} , PO_4^{3-}). Conventional primary and secondary treatment processes remove approximately 10-30% of the phosphorus in wastewater. This may not be sufficient to meet environmental regulations, which often require phosphorus concentrations in effluent to be below 1 mg/l.

The biological process for removing phosphorus is based on exposing the biomass to alternating anaerobic and aerobic conditions, which results in high uptake of phosphorus into cells (Figure 6.2), a process commonly referred to as ‘luxury cell uptake’. This alternation of conditions enhances phosphorus removal by special organisms referred to as phosphorus accumulating organisms (PAOs) which are able to uptake 7-8% of their cell mass as phosphorus, whereas other organisms are normally limited to 1-2% uptake.

The cells can then be removed by sedimentation as a P-rich sludge, or the phosphorus can be released from the cells and precipitated chemically, with alum, ferric chloride, or lime. The latter process is commonly known as the PhoStrip™ process (Figure 6.3).

An alternative to the biological approach to phosphorus removal is to precipitate the phosphorus chemically by the addition of lime, alum, or ferric chloride, typically added just prior to primary sedimentation. This causes the precipitation of phosphates as well as hardness cations and organic matter.

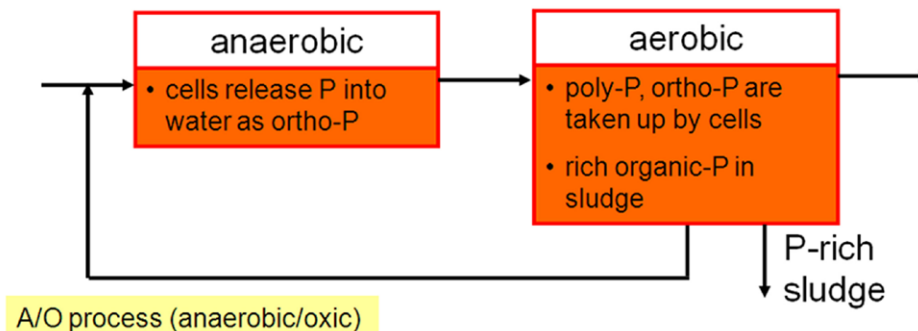

Figure 6.2. Phosphorus removal by cycling between anaerobic and aerobic conditions.

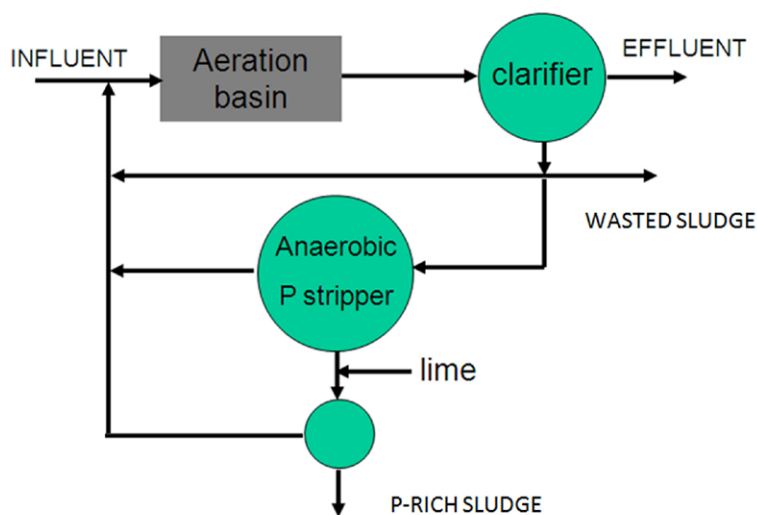
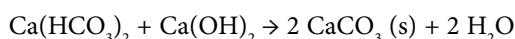
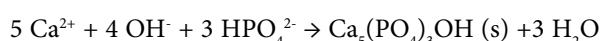

Figure 6.3. The PhoStrip™ process.

A reaction of lime with alkalinity in the wastewater consumes most of the lime and produces CaCO_3 precipitate which aids settling:



Calcium ions also combine with orthophosphate in alkaline solution to form a gelatinous precipitate, calcium hydroxyapatite:



A dose of 100-200 mg/l as calcium hydroxide is typically needed remove approximately 80% of the phosphate.

Scale formation in tanks and pipes is a potential drawback of this approach, as well as the need to dispose large quantities of lime sludge (1.5-2 times the conventional amount).

Aluminium and iron salts can also be used instead of lime. For alum, a simplified form of the phosphate precipitation reaction is:

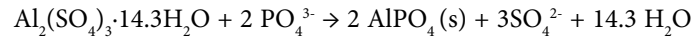

The actual reaction is more complex, due to secondary reactions with alkalinity and colloidal solids. However, in general 1.6-2.6 moles of alum (Al^{3+}) or 1.8-2.2 moles of iron (Fe^{3+}) are needed per mole of phosphorus removed. A dose of 50-200 mg/l of alum is typically needed to remove 80-95% of phosphate. Moderately larger quantities of sludge are produced (1.35-1.45 times the conventional amount). Alum and iron salts also improve sludge settleability and dewaterability.



Do you have to be a banker to **work** in investment banking?

Deutsche Bank
db.com/careers

Agile minds **value ideas** as well as experience

Global Graduate Programs

Ours is a complex, fast-moving, global business. There's no time for traditional thinking, and no space for complacency. Instead, we believe that success comes from many perspectives — and that an inclusive workforce goes hand in hand with delivering innovative solutions for our clients. It's why we employ 135 different nationalities. It's why we've taken proactive steps to increase female representation at the highest levels. And it's just one of the reasons why you'll find the working culture here so refreshing.

Discover something different at db.com/careers

Passion to Perform



7 Disinfection

Although not always a requirement, wastewater treatment works often include a disinfection step at the end of the process (i.e. after secondary clarification). Disinfection may be included to protect a particularly sensitive receiving water – e.g. if the receiving water is a bathing water. The most commonly used disinfectants in wastewater treatment are chlorination and ultraviolet (UV) disinfection.

Chlorination involves the addition of either chlorine gas or sodium hypochlorite solution into the wastewater in sufficient quantities to overcome the chlorine demand of the wastewater, and then allowing the chlorine residual (normally a few milligrams per litre) to remain in contact with the water for a set period of time (normally on the order of several minutes) in a baffled chlorine contact tank. The chlorine residual is then normally eliminated by a de-chlorination step prior to discharge of the effluent, to prevent chlorine release into the aquatic environment. A drawback of chlorination is the formation of a number of toxic chemical by-products due to the reaction of the chlorine with organic compounds in the wastewater.

UV disinfection is a popular disinfection alternative in wastewater treatment since it does not require a contact tank, does not require a step to neutralise the active disinfecting agent (as in de-chlorination), and produces few by-products compared to chlorination. UV disinfection reactors are typically open channel, with the water spending only seconds in contact with the UV light. The UV light is generated by mercury arc-discharge lamps which are contained in quartz sleeves and oriented either perpendicular or parallel to the flow (Figure 7.1). The lamp sleeves must be cleaned regularly (e.g. every day or several times per week) and replaced regularly (e.g. every few months or years). UV reactors for wastewater treatment are typically designed to deliver a UV fluence of between 20-100 mJ/cm², which provides high levels of inactivation of indicator organisms (e.g. total and faecal coliform bacteria) as well as a range of waterborne pathogens.

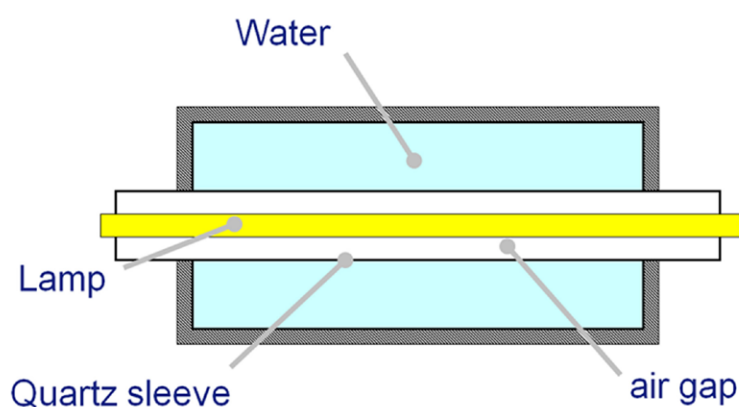

Figure 7.1. A UV lamp contained within a quartz sleeve and immersed in water.

An important water quality parameter in the design (and cost) of the UV disinfection process is the UV transmittance (UVT) of the wastewater, which is a measure of how much UV light is absorbed by the chemical constituents in the wastewater. This is measured using a UV spectrophotometer at a wavelength of 254 nm. Wastewater UVT values range from 30-65% typically, while drinking water UVT values typically range from 85-98%. The lower the UVT of the water, the more UV light must be supplied per lamp or the more UV lamps must be included within the reactor, in order to achieve closer spacing between the lamps. Iron and humic matter are particularly UV-absorbing constituents of wastewater.

Also, suspended solids in the effluent can limit the performance of both chemical and UV disinfection processes, by shielding target pathogens from the disinfecting agent. This is why the disinfection process is normally applied at the end of the wastewater treatment process, when suspended solids concentrations are lowest.

8 Sludge Treatment

Sewage sludge is collected from primary and secondary treatment and must itself be treated. In its untreated state it is malodorous and contains pathogens and toxic elements and compounds. The aims of sludge treatment are to:

- Reduce the volume and bulk of the sludge
- Reduce pathogens in the sludge
- Minimise the costs of disposal and transport of the sludge
- Reduce odour and vector attraction to the otherwise putrescible solids
- Satisfy environmental requirements and public perception / concerns
- Generate energy (sometimes).

Primary sludge contains inorganic solids as well as coarser organic solids. It is more granular and concentrated than secondary sludge. Primary sludge is typically 2-6% dry solids by mass. The mass production of primary sludge (M_{ps} , in kg/day) from the primary sedimentation tank can be estimated as:

$$M_{ps} = \epsilon \times SS \times Q$$

where ϵ is the efficiency of the primary tank, SS is the influent suspended solids concentration, and Q is the flow rate.

**Real drive.
Unreal destination.**

As an intern, you're eager to put what you've learned to the test. At Ernst & Young, you'll have the perfect testing ground. There are plenty of real work challenges. Along with real-time feedback from mentors and leaders. You'll also get to test what you learn. Even better, you'll get experience to learn where your career may lead. Visit ey.com/internships.

[See More | Opportunities](#)

© 2012 Ernst & Young LLP. All Rights Reserved.

ERNST & YOUNG
Quality In Everything We Do

Secondary sludge is mainly composed of biological solids. Its composition is more variable than primary sludge, depending on process variables (e.g. attached growth processes produce more particulate sludge, whereas activated sludge produces light, flocculent sludge). Secondary sludge is typically 0.5-2% dry solids for activated sludge processes, or 4-7% for humus from attached growth processes. The mass production rate of secondary sludge (M_{ss} , in kg/day) can be estimated as:

$$M_{ss} = Y_{obs} \times L \times Q$$

where Y_{obs} = observed biomass yield, L is the BOD_5 removed by the secondary treatment, and Q is the flow rate. The value of Y can be related to the food-to-microorganism ratio and is typically 0.2-0.4.

Sludge treatment involves a number of steps and process options (Figure 8.1), the selection and extent of which depends on factors such as the site-specific composition of the sludge, the available budget for sludge treatment, and the intended fate of the final treated sludge. Generally these can be considered in the following common steps:

- Thickening
- Pre-treatment
- Digestion (also called Stabilisation)
- Conditioning
- De-watering
- Thermal reduction
- End-use or disposal.

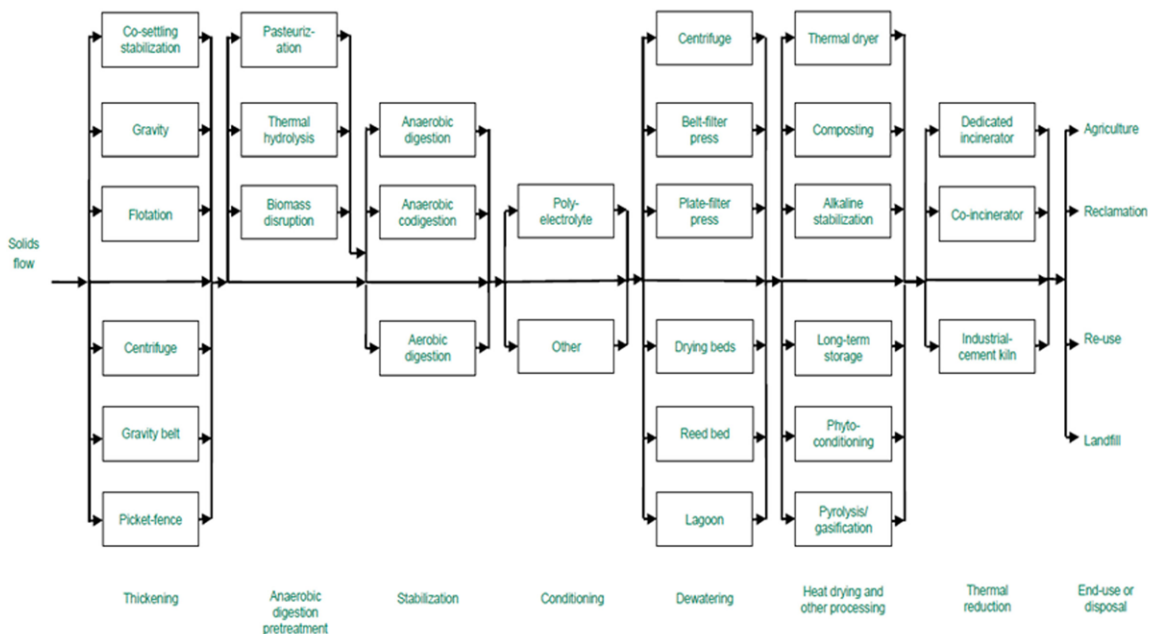

Figure 8.1. Sludge treatment options. (Credit: Prof Stephen R. Smith, Imperial College London).

Anaerobic digestion is the most popular form of sludge treatment in the UK. It produces a biorenewable energy source in the methane gas that is released, and can also produce a sludge that is acceptable for agricultural usage as a soil conditioning material.

Digestion involves the degradation of sewage sludge by mixed populations of bacteria usually at mesophilic temperatures (35 degrees Celsius). A typical process would apply 12 days of mesophilic primary digestion at 35 degrees Celsius, followed by 14 days of secondary digestion at ambient temperatures. Mechanical or gas mixing is applied to provide homogeneous conditions and reduce by-pass flow of sludge.

The total required volume of the digester (V) can be estimated as:

$$V = (Q_1 + Q_2) / t_1 + Q_2 \times t_2$$

where Q_1 = raw sludge loading rate, Q_2 = digested sludge accumulation, t_1 = solids retention time, and t_2 = digested sludge storage period.

Typically approximately 50-60% of the organics are metabolised, with < 10% converted to biomass. Digestion achieves a 50% reduction in volatile solids.

Volatile solids loading rates can range from 1.6-6.4 kg per m³ per day. Typical gas production is 0.6-0.65 m³ per kilogram of volatile solids added, with 65% of this (by volume) being methane and the remaining 35% being carbon dioxide and trace gases (e.g. hydrogen sulphide).

The secondary stage of digestion increases solids separation, collects residual gas, and increases pathogen removal. Mechanical de-watering can increase solids content at this stage to 20-30%.

The digester gas is combusted for digester heating and to provide the plant building heating and hot water. Excess amounts are typically used to drive a generator for electricity production or flared-off.

Some of the advantages and disadvantages of anaerobic digestion are summarised in Table 8.2.

Table 8.2. Advantages and disadvantages of anaerobic digestion. (Credit: Prof Stephen R. Smith, Imperial College London.)

Advantages	Disadvantages
Can deal with strong organic liquors (BOD>500 mg l ⁻¹ , 6-9 % ds)	Increased biomass retention times (MCRT) necessary for weak effluents (<3.5% ds). ds≥3.5% needed for positive energy balance
No aeration required	Slow to start up - anaerobic bacteria slow growing
High degree of purification	Solubilised organic matter in final effluent amenable to quick aerobic treatment - usually necessary
Stable process once started	Needs operator experience
Small quantity of excess sludge	
Methane gas by-product of anaerobic digestion: <ul style="list-style-type: none"> • Usually sufficient to sustain digestion • Surplus used for local heating and power production 	Sensitive to toxic substances
Simple and economically viable	

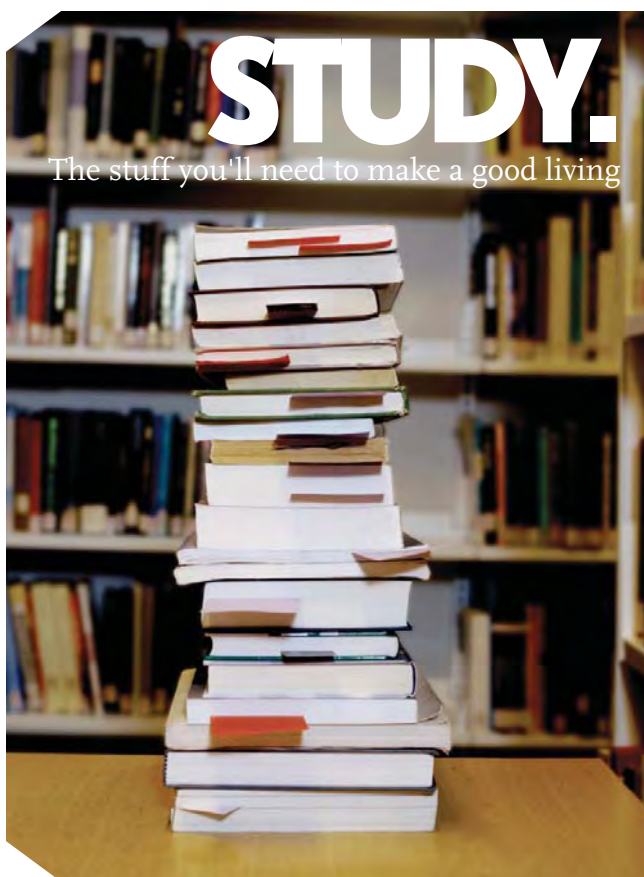

 [Click on the ad to read more](#)

Other processes for treating sewage sludge which may be used in combination with or in place of anaerobic digestion include:

- Incineration
- Composting
- Thermal drying
- Pyrolysis
- Gasification
- Alkali (lime) treatment
- Aerobic digestion
- Pasteurisation
- Thermal hydrolysis
- Novel processes (e.g. gamma irradiation, vitrification).

9 Wastewater Management in Developing Countries

In developing countries, many people still do not have access to any form of improved sanitation and continue to practice open defecation, especially in remote rural areas. Urban areas are typically serviced by centralised wastewater treatment facilities which use the same processes as described in the previous chapters, although the operation of these facilities is often poorly managed, leading to sub-optimal performance.

In rural areas or peri-urban slum areas, however, there is often no piped sewerage system and instead people make attempts to isolate their waste using onsite sanitation provisions, typically at household level. The simplest form of this is a bucket or vault into which the human waste is collected and periodically emptied (e.g. on a daily basis), although the disposal site is not always in a location that is safe from a health protection standpoint. Another very common form of onsite sanitation is the pit latrine (Figure 9.1), consisting of a squatting hole or plate directly above a pit in the ground into which the excreta falls. Conditions within the pit are partially anaerobic, promoting carbon dioxide and methane formation but also malodorous gases. The excreta gradually decomposes and a solid residue accumulates. Water, urine and other liquids infiltrate into the soil through the pit walls and base.

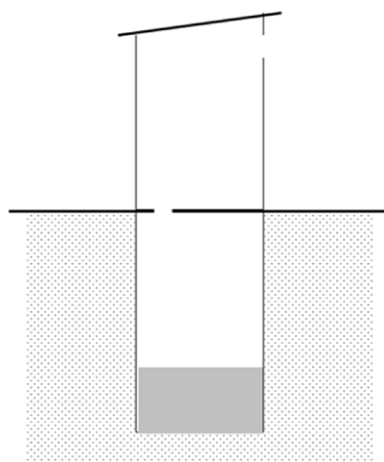

Figure 9.1. A simple pit latrine. Adapted from Butler and Davies (2011).

Pits are usually 1 metre in diameter and up to 3 metres deep. When the residue reaches approximately 0.5 m from the top of the pit, a decision must be made to either abandon the pit or to attempt to empty the pit. Current research is focused on novel latrine designs for prolonging the lifetime of pits and finding easier and safer ways of emptying pits, which remains a significant challenge.

Even simple latrines can be a satisfactory form of sanitation provided:

- The pit is deep and dark, so as to not attract flies

- The floor is smooth, impervious, clean and raised above ground level to prevent ingress of surface rainwater runoff into the pit
- At least the top metre of the pit is lined (e.g. with concrete) to prevent pit collapse.

Pit latrines require only 1-2 m² of land area, making them suitable even in areas with relatively high population densities. The effective pit volume (V) can be calculated using:

$$V = p \times T \times r$$

where p is the number of users, T is the interval between de-sludging, and r is the sludge accumulation rate (Table 9.1).

Table 9.1. Estimates of sludge accumulation rates in pits.

Type	Accumulation rate (m ³ per capita per year)
Wet pit/water-based anal cleansing	0.04
Wet pit/solid-based cleansing	0.06
Dry pit/water-based cleansing	0.06
Dry pit/solid-based anal cleansing	0.09

I joined MITAS because
I wanted **real responsibility**

The Graduate Programme
for Engineers and Geoscientists
www.discovermitas.com



Month 16
I was a construction supervisor in the North Sea advising and helping foremen solve problems

Real work
International opportunities
Three work placements







Ventilation can be used to overcome the common complaints of bad odours and flies (Figure 9.2). A ventilated improved pit (VIP) latrine consists of a slightly offset pit with a vertical vent pipe and fly-proof netting at the pipe top. The latrine is kept dark so that the flies hatched in the pit are attracted to the light at the top of the vent, where they are trapped in the netting and die. Also, wind across the vent top causes low pressure and an updraft extracting odours. The pipe is painted black to help heat the air inside, causing it to rise and ventilate the pit.

Pit latrines and VIP latrines are 'dry' forms of onsite sanitation, i.e. they do not require any input of water. A common 'wet' form of onsite sanitation is the pour-flush latrine, which provides an alternative solution to the odour and fly problem. A pour-flush latrine consists of a pan and trap with a water seal above the pit. Well-designed pans can be washed down with 1-3 litres of water only, poured from a hand-held vessel. This has the additional benefit of removing the direct line-of-sight between the user and the faeces in the pit. The design of pour-flush latrines must be carefully checked to ensure adequate infiltration into the soil because of the increased amount of liquid.

Other variations of latrines exist and considerable variation in design can be found from country to country or even region to region, due to different local materials used in the construction, the preferences of the users, climatic conditions (e.g. amount of rainfall), and other factors.

Many users of latrines aspire to someday own septic tanks, which are considered as the next step up the sanitation ladder. A septic tank (Figure 9.3) is a watertight underground vessel that provides conditions suitable for the settlement, storage, and decomposition of excreta. Wastewater is fed directly to the tank, through which it flows, and then on to a discharge field. Direct discharge to a stream, ditch, or open drain is not recommended but is common practice in developing countries.

For domestic applications a detention time of 24 hours in the septic tank is normally needed, although the retention time can be safely reduced (e.g. to 12 hours) if tanks serve larger households or groups of properties.

A crust of solidified grease and oil forms on the surface. Sludge also accumulates at the bottom of the tank over time, therefore, as with latrines, septic tanks must be emptied periodically. A common design aim is for tank emptying to only need to be done every few years (e.g. 2-5 years), although the frequency of emptying varies widely depending on a number of factors, such as the number of users and whether other materials are discarded into the tank (e.g. rubbish). The de-sludging interval should be short enough such that the tank does not become blocked, but long enough to allow anaerobic reduction of the sludge volume.

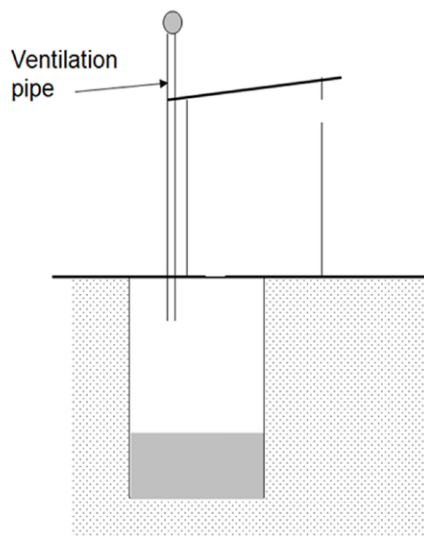

Figure 9.2. A ventilated improved pit (VIP) latrine. Adapted from Butler and Davies (2011).

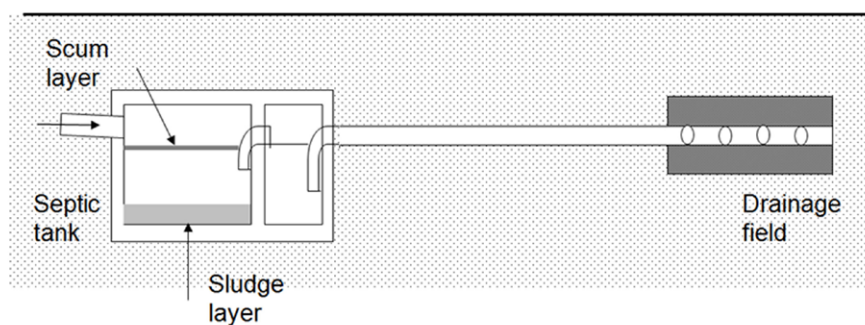

Figure 9.3. A septic tank. Adapted from Butler and Davies (2011).

The volume of liquid accumulation in the septic tank can be estimated simply as:

$$V_l = Q \times t$$

where Q is the estimated daily inflow (e.g. litres per day) and t is the retention time.

The volume of sludge and scum accumulation in the tank can be estimated as:

$$V_{sl} = p \times T \times F \times r$$

where p is the number of users, T is the interval between de-sludging, r is the rate of sludge and scum accumulation (0.025 m^3 per capita per year for toilet wastes only and 0.04 m^3 per capita per year with sullage), and F is a factor relating the sludge digestion rate to the temperature and de-sludging interval (1.0 for relatively high temperatures and de-sludging intervals, and up to 2.5 for relatively low temperatures and de-sludging intervals).

The total tank volume then should be:

$$V = V_1 + V_{sl}$$

The total tank volume should be at least 1 m^3 .

Septic tanks require more space than pit latrines, roughly $10\text{-}100 \text{ m}^2$, and they are more expensive to construct and operate.

In all forms of onsite sanitation it is crucial to ensure protection against contamination of nearby water sources (e.g. shallow groundwater wells) through proper siting of the sanitation facilities. This is especially important in areas with high groundwater tables and/or high soil infiltration capacity.

There is interest in recovering biogas from sludge in developing countries, especially where other sources of fuel are not abundant or expensive. Food waste and livestock waste is commonly co-digested in small-scale (i.e. community-scale) sludge digesters with the resulting biogas used for applications such as cooking stoves, lamps, and small engines. Inadequate emphasis on maintenance and repair of digesters often restricts the biogas recovery efficiency and sustainability, however.

Need help with your dissertation?

Get in-depth feedback & advice from experts in your topic area. Find out what you can do to improve the quality of your dissertation!

Get Help Now



Go to www.helpmyassignment.co.uk for more info



Click on the ad to read more

10 Emerging Trends and Concerns in Wastewater Treatment

Much of what has been described in this book is a summary of conventional ways of treating wastewater for achieving the traditional main aims of wastewater treatment. However, the following are a few emerging trends and concerns which may change these aims and practices in the future:

The meaning of DWF in a changing climate. Earlier it was described that wastewater treatment works are designed to treat a multiple of the dry weather flow (DWF), typically a factor of three times the DWF, and that additional storm storage is provided when wastewater treatment works receive water from combined sewer networks, i.e. which transport stormwater and wastewater in the same sewer. The recommended amount of storm storage is based primarily on experience and knowledge of the time-intensity characteristics of historic storm event data. However, with climate change leading to more frequent intense storms than in the past, the prevailing wisdom for how much storm storage to provide in wastewater treatment works, and also in combined sewer overflows (CSOs) within the sewer network itself, may need to be revisited in order to prevent an increased number of pollution incidents due to flows exceeding design capacities. Uncertainties regarding future storm event characteristics should be carefully considered alongside the costs and benefits of providing additional storm storage in wastewater treatment works.

Organic micro-pollutants. It was described earlier how BOD, suspended solids, and nutrients are the commonly targeted parameters for defining effluent water quality. Increasingly however, there is concern over a range of organic micro-pollutants which may escape conventional wastewater treatment and pass into receiving waters. These include pharmaceutical residues, endocrine-disrupting compounds, plasticizers, flame-retardants, pesticides, and a range of other anthropogenic compounds. These chemicals have come to our attention partly because of the development of improved analytical methods for measuring them at the very low concentrations at which they are typically found in wastewater. Also, toxicological studies have proven that there can be harmful effects on aquatic life (e.g. fish, frogs) from exposure to wastewater effluents containing such compounds, even at relatively low concentrations. While advanced treatment processes such as ozonation, membrane filtration, and activated carbon adsorption may be effective for destroying or physically removing these compounds from water, the capital costs and energy-intensive nature of operating such processes are often deemed to be unjustifiable at full-scale. The future solution may be found in a combination of measures, including controlling the release of these compounds into sewers whenever possible, the optimisation of conditions in conventional wastewater treatment works to maximise the removal of these compounds, and the development of new technologies which are cheaper, more effective, and have lower energy demands than the current treatment options.

Reducing the carbon footprint of treatment. Carbon footprint reduction is now a prevailing objective across many sectors in society, and the wastewater industry is no exception. In the UK, ambitious targets have been set to reduce the carbon footprint of the water and wastewater industry. Most of the carbon footprint in wastewater treatment is associated with aeration and pumping; while pumping in the sewer network is not something that can be easily changed in the case of existing sewer networks and wastewater treatment works, the optimisation of aeration or the increasing use of anaerobic processes may be a part of the solution to reducing energy consumption. It may also be sensible to instead attempt to achieve ‘carbon-neutral’ treatment, which is a subtle difference and emphasises the importance of producing energy from the wastewater sludge (e.g. from anaerobic digestion) to offset the energy consumption associated with the collection and treatment of wastewater.

Water reuse. In many parts of the world, water supplies for domestic consumption, agriculture, and industrial uses are no longer able to keep up with demand. Water reuse, i.e. using treated wastewater for these purposes, is becoming more commonly considered as a viable option for addressing these needs. Of course, indirect reuse occurs in many places already anyways, for example in the common case where a wastewater treatment works discharges its effluent into a river that is subsequently used as source water for drinking water production at some point downstream. However, direct potable reuse can present a number of treatment challenges, in terms of needing to achieve very high levels of pathogen reduction and elimination of micro-pollutants, as well as public acceptance issues. That said, water reuse is being practiced in countries such as Singapore and the US (southern California) currently.

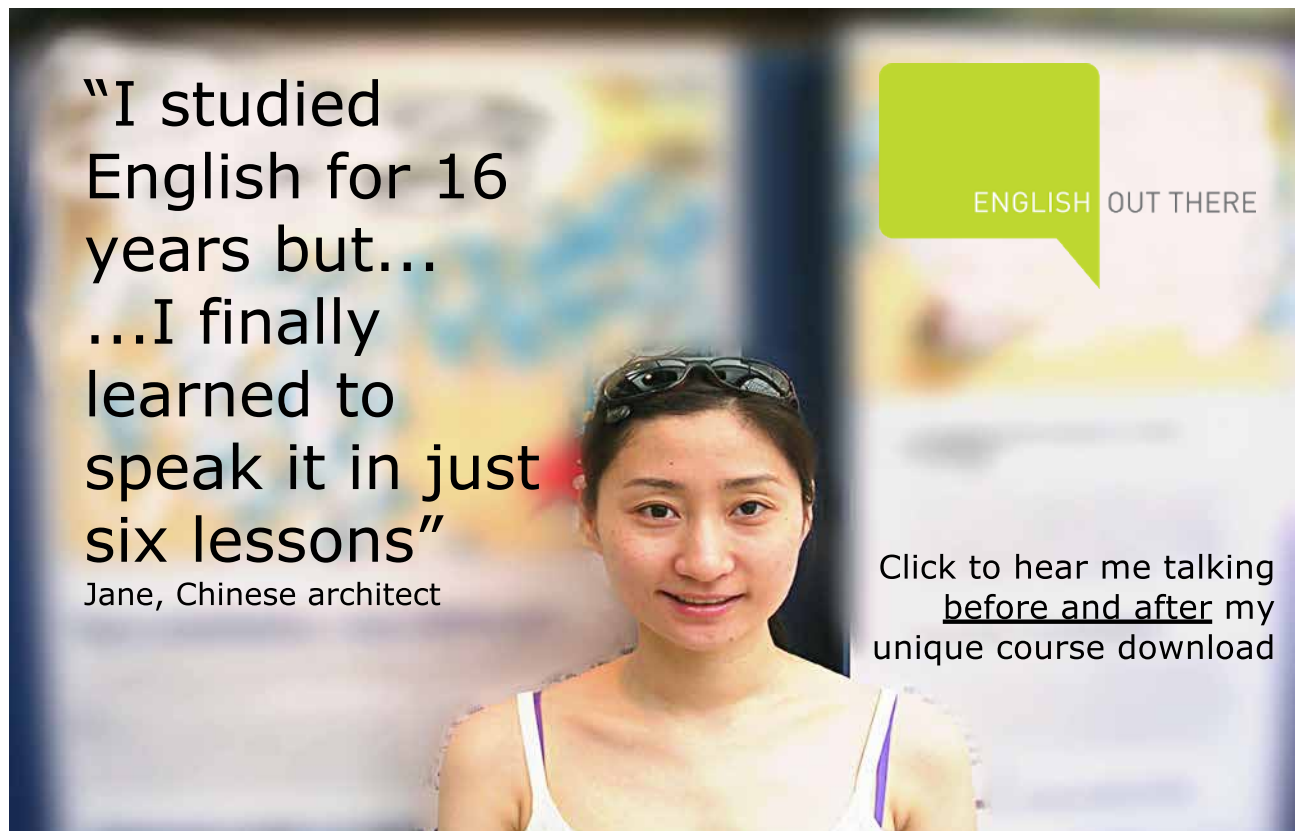

“I studied English for 16 years but...
...I finally learned to speak it in just six lessons”
Jane, Chinese architect

ENGLISH OUT THERE

Click to hear me talking before and after my unique course download



References / Further Reading

Butler, D. and Davies, J.W. (2011). *Urban Drainage* (3rd edition). Spon Press. ISBN-13: 978-0415455268.

Hammer, M.J. and Hammer Jr, M.J. (2011). *Water and Wastewater Technology* (7th edition). Prentice-Hall. ISBN-13: 978-0135114049.

Metcalf & Eddy, Inc. (2002). *Wastewater Engineering – Treatment and Reuse* (4th edition). McGraw-Hill. ISBN-13: 978-0070418783.

Qasim, S.R. (1998). *Wastewater Treatment Plants: Planning, Design & Operation* (2nd edition). CRC Press. ISBN-13: 978-1566766883.

Tebbutt, T.H.Y. (1998). *Principles of Water Quality Control* (5th edition). Butterworth-Heinemann. ISBN-13: 978-0750636582

Viessman, W. and Hammer, M.J. (1998). *Water Supply and Pollution Control* (6th edition). Prentice-Hall. ISBN-13: 978-0321014603.