

Wind Turbines

T. Al-Shemmeri



Download free books at

bookboon.com

T. Al-Shemmeri

Wind Turbines

Wind Turbines

© 2010 T. Al-Shemmeri & Ventus Publishing ApS

ISBN 978-87-7681-692-6

Contents

	Preface	7
	Dimensions and units	9
1	Energy & the Environment	15
1.1	Introduction	15
1.2	Forms of energy	15
1.2.1	Mechanical energy	16
1.2.2	Electrical energy	17
1.2.3	Chemical energy	18
1.2.4	Nuclear energy	19
1.2.5	Thermal energy	20
1.3	Energy conversion	20
1.4	Environmental Impact from fossil fuels	23
1.5	Energy world-wide	25
2	Wind Energy	27
2.1	Introduction	27
2.2	Siting of Wind turbines	28
2.3	Planning Constraints for wind turbines:	30
2.3.1	Steps to Planning and Building a Wind Farm	30
2.4	Wind Energy and the Environment	33

Please click the advert

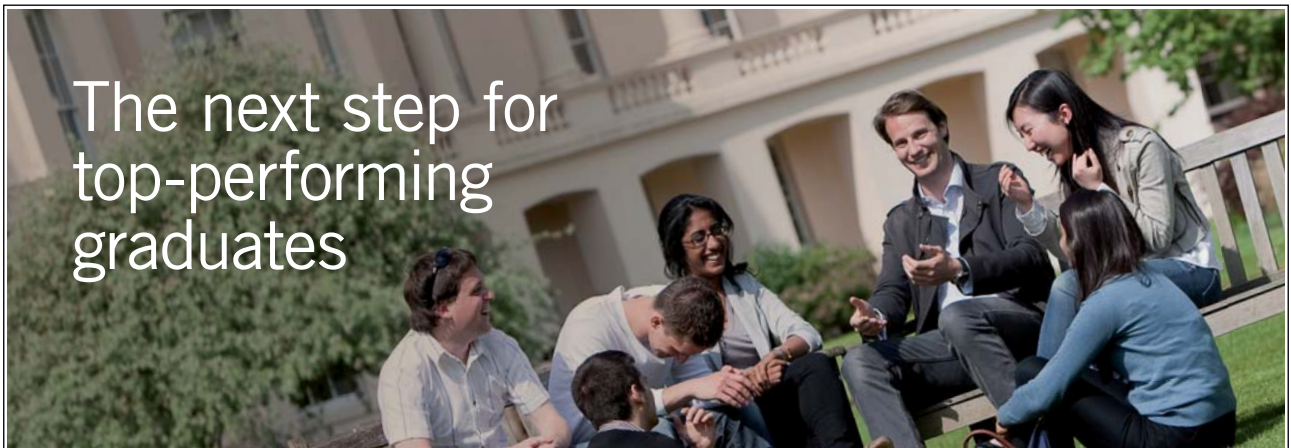

Masters in Management

Designed for high-achieving graduates across all disciplines, London Business School's Masters in Management provides specific and tangible foundations for a successful career in business.

This 12-month, full-time programme is a business qualification with impact. In 2010, our MiM employment rate was 95% within 3 months of graduation*; the majority of graduates choosing to work in consulting or financial services.

As well as a renowned qualification from a world-class business school, you also gain access to the School's network of more than 34,000 global alumni – a community that offers support and opportunities throughout your career.

For more information visit www.london.edu/mm, email mim@london.edu or give us a call on **+44 (0)20 7000 7573**.

* Figures taken from London Business School's Masters in Management 2010 employment report



2.4.1	Positive environmental benefits of Wind energy	33
2.4.2	Negative Impacts of Wind energy	33
3	Theory of Wind Energy	38
3.1	Conservation of Mass:	38
3.2	Conservation of Energy:	39
3.3	Conservation of Momentum	40
3.4	Ideal Wind Power calculations:	41
3.3.1	Theory of Wind Turbines	42
3.3.2	Distinction between rated and actual power output of the turbine	44
4	Wind Turbines types and components	46
4.1	Types of Wind Turbines	46
4.2	Components of a Wind Turbine	46
4.3	Relationship between Wind speed and Rotor speed	49
5	Wind Energy Measurements	50
5.1	Electrical measurements	50
5.1.1	Ohms Law	51
5.1.2	Electrical Power	51
5.1.3	Alternating Current Power	51
5.1.4	Electrical Measurements	53
5.2	Velocity and flow measured by Anemometers	55
5.2.1	The ‘cup type’ air speed measurement	55
5.2.2	The ‘vane anemometer’	55

Please click the advert

Excellent Economics and Business programmes at:



**university of
 groningen**



“The perfect start
 of a successful,
 international career.”

CLICK HERE
 to discover why both socially
 and academically the University
 of Groningen is one of the best
 places for a student to be

www.rug.nl/feb/education

5.2.3	The ‘hot-wire’ anemometer’	57
5.3	Measurement of speed of rotation	57
5.3.1	Mechanical Tachometer	57
5.3.2	Electrical Tachometers	58
5.3.3	Stroboscope	59
5.3.4	Magnetic Field Angular Position Sensors	59
5.3.5	Wheel encoder	61
5.4	The importance of speed in Turbine’s measurements	61
6	Worked Examples	63
7	Tutorial Problems	73
8	Case Study	76
8.1	Site Survey of wind energy and wind turbine matching	76
8.2	Introduction	77
8.3	Energy and power in the wind	77
8.4	Estimating the Annual Energy Output (A.E.O.)	78
8.5	The Software Package	79
8.6	Discussion	84
8.7	Conclusions	87
8.8	References	87

Please click the advert

Teach with the Best. Learn with the Best.

Agilent offers a wide variety of affordable, industry-leading electronic test equipment as well as knowledge-rich, on-line resources—for professors and students.

We have 100’s of comprehensive web-based teaching tools, lab experiments, application notes, brochures, DVDs/CDs, posters, and more.



See what Agilent can do for you.
www.agilent.com/find/EDUstudents
www.agilent.com/find/EDUeducators

© Agilent Technologies, Inc. 2012

u.s. 1-800-829-4444 canada: 1-877-894-4414

Anticipate — Accelerate — Achieve



Preface

This book is concerned with the subject of Wind Energy, as a source of clean and renewable and free for all. The need for this type of book is very well documented, the current consumption of energy is unsustainable and humans have to change their habits and or utilise this source, but there is so much work before we can rely completely on renewable energy. This book aims to describe the fundamentals of wind energy and the pertinent parameters that control the amount of energy available from a given wind turbine.

Coal fuelled the industrial revolution in the 18th and 19th century. It remained as the prime fuel supplying steam engines used in road vehicles and rail road trucks. The industrialised nations were in huge competition in their search for additional fuels and the discovery of oil in the Middle East and elsewhere extended the use oil opening the applications to a wider range. With the advent of the automobile, airplanes and the spreading use of electricity, oil became the dominant fuel during the twentieth century. The Arab-Israeli wars in the 1967 and 1972; the price of oil increased from 5 to 45 US dollars per barrel, there was a shift away from oil. Coal and nuclear became the fuels of choice for electricity generation and conservation measures increased energy efficiency. The use of fossil fuels has continued to grow and their share of the energy supply has increased. The more recent invasion of Iran, and subsequently Kuwait and the eventual occupation of Iraq are all clear evidence of the importance of oil to the west.

In 2008, total worldwide energy consumption was 474 exajoules (474×10^{18} J) with 80 to 90 percent derived from the combustion of fossil fuels.

The estimates of remaining non-renewable worldwide energy resources vary, with the remaining fossil fuels totaling an estimated 400000 EJ (1 EJ = 10^{18} J) and the available nuclear fuel such as uranium exceeding 2500000 EJ. The Sun, provides the world with a renewable usable energy of 3800000 EJ/yr, dwarfing all non-renewable resources. However, it is there to be utilised. The sun energy needs to be harnessed, stored, and converted into the required form for a particular use. Whatever fossil fuel remains will be more and more difficult to mine, and as it become scarcer the security of supply will become a major issue, with the definite outcome that the cost will exponentially increase and that would lead ultimately to major quarrels and possibly wars.

In order to move away from fossil fuels it is expected to create economic pressure through Carbon trading and Green taxation. Some countries are taking action as a result of the Kyoto Protocol, and further steps in this direction are proposed. For example, the European Union Commission has proposed that the Energy Policy should set a binding target of increasing the level of renewable energy in the EU's overall mix from less than 7% today to 20% by 2020.

Wind Energy is natural and renewable, wind turbines are similar to hydraulic turbines, hence the technology is mature and well establish. What is good about wind energy, its available even in winter, when solar energy is not so good, so it makes a natural compliment to solar energy.

Wind energy is becoming popular despite some concerns about visual impact and so on, and it is one of the most competitive renewable energy in most cases. According to the World Wind Energy Association, the installed capacity of wind power increased by 29% from the end of 2007 to the end of 2008 to total 121 GW, with over half the increase in the United States, Spain and China.

This book tackles the fundamental principles of wind energy; and how it can be harnessed and used efficiently. A case study is provided at the end of the book to demonstrate how best to evaluate the wind energy potential for a locality, plan, select the best wind turbine for that particular application, and use wind energy.

Dimensions and units

Any physical situation, whether it involves a single object or a complete system, can be described in terms of a number of recognisable properties which the object or system possesses. For example, a moving object could be described in terms of its mass, length, area or volume, velocity and acceleration. Its temperature or electrical properties might also be of interest, while other properties - such as density and viscosity of the medium through which it moves - would also be of importance, since they would affect its motion. These measurable properties used to describe the physical state of the body or system are known as its variables, some of which are basic such as length and time, others are derived such as velocity. Each variable has units to describe the magnitude of that quantity. Lengths in SI units are described in units of meters. The meter is the unit of the dimension of length (L); hence the area will have dimension of L^2 , and volume L^3 . Time will have units of seconds (T), hence velocity is a derived quantity with dimensions of (LT^{-1}) and units of meter per second. A list of some variables is given in Table 1 with their units and dimensions.

Definitions of Some Basic SI Units

Mass: The kilogram is the mass of a platinum-iridium cylinder kept at Sevres in France.

Length: The metre is now defined as being equal to 1 650 763.73 wavelengths in vacuum of the orange line emitted by the Krypton-86 atom.

Time: The second is defined as the fraction $1/31\,556\,925.975$ of the tropical year for 1900. The second is also declared to be the interval occupied by 9 192 631 770 cycles of the radiation of the caesium atom corresponding to the transition between two closely spaced ground state energy levels.

Temperature: The Kelvin is the degree interval on the thermodynamic scale on which the temperature of the triple point of water is 273.16 K exactly. (The temperature of the ice point is 273.15 K).

Definitions of Some Derived SI Units

Force:

The Newton is that force which, when acting on a mass of one kilogram gives it an acceleration of one metre per second per second.

Work Energy, and Heat:

The joule is the work done by a force of one Newton when its point of application is moved through a distance of one metre in the direction of the force. The same unit is used for the measurement of every kind of energy including quantity of heat.

The Newton metre, the joule and the watt second are identical in value. It is recommended that the Newton is kept of the measurement of torque or moment and the joule or watt second is used for quantities of work or energy.

Quantity	Unit	Symbol
Length [L]	Metre	m
Mass [m]	Kilogram	kg
Time [t]	Second	s
Electric current [I]	Ampere	A
Temperature [T]	degree Kelvin	K
Luminous intensity [Iv]	Candela	cd

Table 1: Basic SI Units.

Quantity	Unit	Symbol	Derivation
Force [F]	Newton	N	kg-m/s ²
Work, energy [E]	joule	J	N-m
Power [P]	watt	W	J/s
Pressure [p]	Pascal	Pa	N/m ²

Table 2: Derived Units with Special Names

Quantity	Symbol
Area	m^2
Volume	m^3
Density	kg/m^3
Angular acceleration	rad/s^2
Velocity	m/s
Pressure, stress	N/m^2
Kinematic viscosity	m^2/s
Dynamic viscosity	$N\cdot s/m^2$
Momentum	$kg\cdot m/s$
Kinetic energy	$kg\cdot m^2/s^2$
Specific enthalpy	J/kg
Specific entropy	$J/kg\ K$

Table 3: Some Examples of Other Derived SI Units

Quantity	Unit	Symbol	Derivation
Time	minute	min	60 s
Time	hour	h	3.6 ks
Temperature	degree Celsius	$^{\circ}C$	$K - 273.15$
Angle	degree	$^{\circ}$	$\pi/180$ rad
Volume	litre	l	$10^{-3} m^3$ or dm^3
Speed	kilometre per hour	km/h	-
Angular speed	revolution per minute	rev/min	-
Frequency	hertz	Hz	cycle/s
Pressure	bar	b	10^2 kN/m ²
Kinematic viscosity	stoke	St	100 mm ² /s
Dynamic viscosity	poise	P	100 mN \cdot s/m ²

Table 4: Non-SI Units

Name	Symbol	Factor	Number
exa	E	10^{18}	1,000,000,000,000,000,000
Peta	P	10^{15}	1,000,000,000,000,000
tera	T	10^{12}	1,000,000,000,000
giga	G	10^9	1,000,000,000
mega	M	10^6	1,000,000
kilo	k	10^3	1,000
hecto	h	10^2	100
deca	da	10	10
deci	d	10^{-1}	0.1
centi	c	10^{-2}	0.01
milli	m	10^{-3}	0.001
micro	μ	10^{-6}	0.000001
nano	n	10^{-9}	0.000000001
pico	p	10^{-12}	0.000000000001
femto	f	10^{-15}	0.000000000000001
atto	a	10^{-18}	0.000000000000000001

Table 5: Multiples of Units

item	conversion
Length	1 in = 25.4 mm 1 ft = 0.3048 m 1 yd = 0.9144 m 1 mile = 1.609 km
Mass	1 lb. = 0.4536 kg (0.453 592 37 exactly)
Area	1 in ² = 645.2 mm ² 1 ft ² = 0.092 90 m ² 1 yd ² = 0.8361 m ² 1 acre = 4047 m ²
Volume	1 in ³ = 16.39 cm ³ 1 ft ³ = 0.028 32 m ³ = 28.32 litre 1 yd ³ = 0.7646 m ³ = 764.6 litre 1 UK gallon = 4.546 litre 1 US gallon = 3.785 litre
Force, Weight	1 lbf = 4.448 N
Density	1 lb/ft ³ = 16.02 kg/m ³
Velocity	1 km/h = 0.2778 m/s 1 ft/s = 0.3048 m/s 1 mile/h = 0.4470 m/s = 1.609 km/h
Pressure, Stress	1000 Pa = 1000 N/m ² = 0.01 bar 1 in H ₂ O = 2.491 mb 1 lbf/in ² (Psi) = 68.95 mb or 1 bar = 14.7 Psi
Power	1 horsepower = 745.7 W
Moment, Torque	1 ft-pdl = 42.14 mN-m
Rates of Flow	1 gal/h = 1.263 ml/s = 4.546 l/h 1 ft ³ /s = 28.32 l/s
Fuel Consumption	1 mile/gal = 0.3540 km/l
Kinematic Viscosity	1 ft ² /s = 929.0 cm ² /s = 929.0 St
Dynamic Viscosity	1 lbf-s/ft ² = 47.88 N-s/m ² = 478.8 P 1 pdl-s/ft ² = 1.488 N-s/m ² = 14.88 P 1cP = 1 mN-s/m ²
Energy	1 horsepower-h = 2.685 MJ 1 kW-h = 3.6 MJ 1 Btu = 1.055 kJ 1 therm = 105.5 MJ

Table 6: Conversion Factors

	Unit	X Factor	= Unit	x Factor	= Unit
Length (L)	ins	25.4	mm	0.0394	ins
	ft	0.305	m	3.281	ft
Area (A)	in ²	645.16	mm ²	0.0016	in ²
	ft ²	0.093	m ²	10.76	ft ²
Volume (V)	in ³	16.387	mm ³	0.000061	in ³
	ft ³	0.0283	m ³	35.31	ft ³
	ft ³	28.32	litre	0.0353	ft ³
	pints	0.5682	litre	1.7598	pints
	Imp. gal	4.546	litre	0.22	Imp gal
	Imp. gal	0.0045	m ³	220	Imp gal
Mass (M)	lb.	0.4536	kg	2.2046	lb.
	tonne	1000	kg		
Force (F)	lb.	4.448	N	0.2248	lb.
Velocity (V)	ft/min	0.0051	m/sec	196.85	ft/min
Volume Flow	Imp gal/min	0.0758	litres/s	13.2	Imp gal/min
	Imp gal/h	0.00013	m ³ /s	7,936.5	Imp gal/h
	ft ³ /min	0.00047	m ³ /s	2,118.6	ft ³ /min
Pressure (P)	lb/in ²	0.0689	bar	14.5	lb/in ²
	kg/cm ²	0.9807	bar	1.02	kg/cm ²
Density (ρ)	lb/ft ³	16.019	kg/m ³	0.0624	lb/ft ³
Heat Flow Rate (Q)	Btu/h	0.2931	W	3.412	Btu/h
	kcal/h	1.163	W	0.8598	kcal/h
Thermal Conductivity (k)	Btu/ft h R	1.731	W/m K	0.5777	Btu/ft h R
	kcal/m h K	1.163	W/m K	0.8598	kcal/m h K
Thermal Conductance (U)	Btu/h ft ² R	5.678	W/m ² K	0.1761	Btu/h ft ² R
	kcal/h m ² K	1.163	W/m ² K	0.8598	kcal/h m ² K
Enthalpy (h)	Btu/lb.	2,326	J/kg	0.00043	Btu/lb.
	kcal/kg	4,187	J/kg	0.00024	kcal/kg

Table 7: Conversion Factors

Simply multiply the imperial by a constant factor to convert into Metric or the other way around.

1 Energy & the Environment

1.1 Introduction

Energy is needed for two functions:

- a. To provide heating, cooking and processing of fluids
- b. To provide electricity to drive machines, or power lights.

The following sections will discuss the various forms of energy, and how energy can be converted from one form to another which convenient for heating, cooling etc.

1.2 Forms of energy

We associate energy with devices whose inputs are fuel based such as electrical current, coal, oil or natural gas; resulting in outputs such as movement, heat or light.

Unit of energy is the Joule (J). The rate of producing energy is POWER which has the unit of Joule per second or the Watt (W).

Please click the advert

Need help with your dissertation?

Get in-depth feedback & advice from experts in your topic area. Find out what you can do to improve the quality of your dissertation!

[Get Help Now](#)



Go to www.helpmyassignment.co.uk for more info



There are FIVE forms of Energy:

- Mechanical Energy
- Electrical Energy
- Chemical Energy
- Nuclear Energy
- Thermal Energy

These energy forms are discussed in the following sections.

1.2.1 Mechanical energy

This type of energy is associated with the ability to perform physical work.

There are two forms in which this energy is found; namely potential energy and kinetic energy.

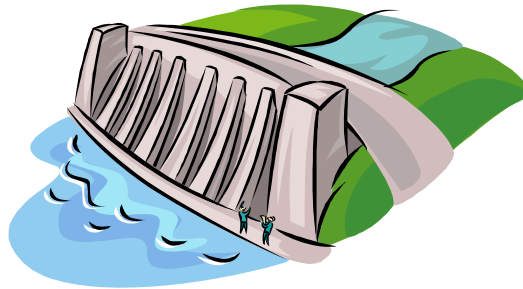

Potential energy

As the name implies is contained in a body due to its height above its surroundings, examples such as the gravitational energy of the water behind a dam, and the energy stored in batteries.

Potential Energy = mass x acceleration due to gravity (9.81) x height above datum

$$E_p = m \times g \times h$$

The energy produced by one kilogram of water falling from a height of 100m above ground is a potential energy, which can be calculated as follows:

Potential Energy = mass x acceleration due to gravity x height above datum

$$E_p = 1 \times 9.81 \times 100 = 981 \text{ J/kg}$$

Kinetic energy

Kinetic energy is related to the movement of the body in question. Examples of KE such as the flywheel effect and the energy of water flowing in a stream.

Kinetic Energy = $\frac{1}{2}$ mass x velocity squared

$$E_k = \frac{1}{2} \times m \times v^2$$

The water stream in a river flowing at a velocity of 2 m/s has a kinetic energy of:

Kinetic Energy = $\frac{1}{2}$ mass x velocity squared = $\frac{1}{2} \times 1 \times (2)^2 = 2$ J/kg

1.2.2 Electrical energy

This type of energy as the name implies is associated with the electrons of materials. Electrical energy exists in two forms:

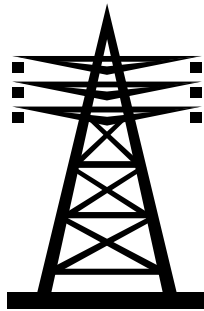

a. Electrostatic electricity

This type of electrical energy is produced by the accumulation of charge on the plates of a capacitor. Charles Coulomb first described electric field strengths in the 1780's. He found that for point charges, the electrical force varies directly with the product of the charges. The greater the charges, the stronger the field. And the field varies inversely with the square of the distance between the charges. This means that the greater the distance, the weaker the force becomes. The formula for electrostatic force, F , is given as:

$$F = k (q_1 \times q_2) / d^2$$

Where q_1 and q_2 are the charges, d is the distance between the charges. And k is the proportionality constant which depend on the material separating the charges.

b. Electromagnetic energy

This type is produced with a combination of magnetic and electric forces. It exists as a continuous spectrum of radiation. The most useful type of electromagnetic energy comes in the form of solar radiation transmitted by the sun that forms the basis of all terrestrial life.

1.2.3 Chemical energy

This type of is associated with the release of thermal energy due to a chemical reaction of certain substances with oxygen. Burning wood, coal or gas is the main source of energy we commonly use in heating and cooking.



Calculation of chemical energy

The energy liberated from the combustion of a given mass of fuel, with a known calorific value in a combustion chamber of known efficiency is given by:

$$\text{Chemical Energy} = \text{Mass of fuel} \times \text{calorific value} \times \text{efficiency of combustion}$$

Please click the advert

Free online Magazines





Click here to download

SpeakMagazines.com

Download free ebooks at bookboon.com

1.2.4 Nuclear energy

This energy is stored in the nucleus of matter, and is released as a result of interactions within the atomic nucleus.

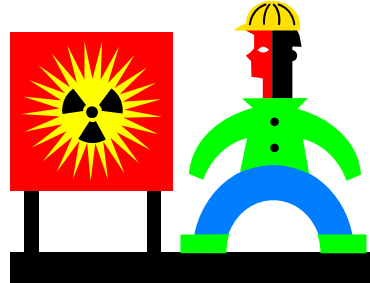

There are three nuclear reactions:

a. Radioactive decay:

In which one unstable nucleus (radioisotope) decays into a more stable configuration resulting in the release of matter and energy

b. Fission:

A heavy nucleus absorbs a neutron splitting it into two or more nuclei accompanied by a release of energy. Uranium U235 has the ability to produce 70×10^9 J/kg

Einstein proposed the following equation to calculate the energy produced from nuclear fissioning (i.e. conversion of matter (m) into energy, E are related to the speed of light C) :

$$E = m C^2$$

This reaction forms the bases for current nuclear power generation plants.

c. Fusion:

Two light nuclei combine to produce a more stable configuration accompanied by the release of energy. Heavy water (Deuterium) fusion reaction may produce energy at the rate of 0.35×10^{12} J/kg.

This reaction is yet to be realised to produce electricity on commercial basis.

1.2.5 Thermal energy

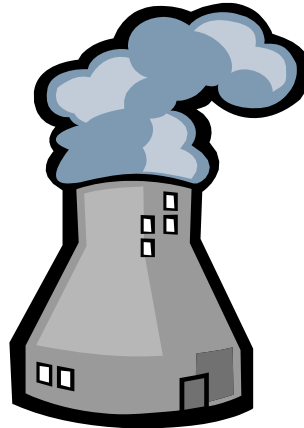

Thermal energy is associated with intermolecular vibration resulting in heat and a temperature rise above that of the surroundings. Thermal energy is calculated for two different regimes:

When the substance in a pure phase, say if it is in a liquid, gas or solid, then
 Thermal Energy = mass x specific heat capacity x temperature difference

During a change of phase, such as evaporation or condensation, it can be calculated by:
 Thermal Energy = mass x latent heat

However, if there is a change of phase, say during the condensation of water vapour into liquid, there is an additional amount of heat released while the temperature remains constant during the change of phase. For 1 kg of water to be heated at ambient pressure from 20 to 120 °C, the requirement is

Thermal energy = heating water (20-100) °C + evaporation at 100 °C + super-heating vapour (100-120) °C

$$\begin{aligned}
 \text{Thermal energy} &= 1 \times 4.219 \times (100-20) + 1 \times 2256.7 + 1 \times 2.01 \times (120-100) \\
 &= 337.52 + 2256.7 + 40.2 \\
 &= 2634.42 \text{ kJ}
 \end{aligned}$$

1.3 Energy conversion

It is important to understand that losses are encountered during the transformation of energy during the different conversions into the final form for a given application, for example consider a wind turbine, the following conversions take place:

Kinetic energy of the oncoming air strikes the rotor blades, turning them, and hence the axial kinetic energy is turned into mechanical energy of the rotating blades.

Some of this mechanical energy is lost in the control mechanism, consisting of the gear box and brake to regulate the speed and match it with that of the generator. Some energy losses are encountered due to friction.

The shaft turning with the remaining energy will rotate in turn the generator; hence converting it's the output into electrical energy (mechanical to electrical).

Some losses are dissipated through the mechanical connections between the turbine and the electrical generator.

Electricity is used by customers for lighting / heating or to operate electric devices such as radio, television, etc. electrical devices are designed to operate on an optimum condition; efficiency of the operation will vary depending on its use, age and maintenance.

The energy flow for a typical wind turbine is shown in Figure 1.1; can be analysed in a simple way by considering the energy flow diagram, which may look like this:

100 units of energy are stored in the incoming air as kinetic energy.

40 units are converted into rotational /mechanical energy by the blades.

35 units are transferred by the shaft; some units are absorbed by the brake and gear.

33 units are converted from mechanical into electrical energy in the electrical generator.

30 units is the net output, as 3 units are lost in voltage conversion, storage and distribution.

The final figure depends on many factors, including the type of turbine, efficiency of the control system, efficiency of the generator, and the quality of the transformer and the distribution system.

Please click the advert



You're full of *energy*
and *ideas*. And that's
just what we are looking for.

Looking for a career where your ideas could really make a difference? UBS's Graduate Programme and internships are a chance for you to experience for yourself what it's like to be part of a global team that rewards your input and believes in succeeding together.

Wherever you are in your academic career, make your future a part of ours by visiting www.ubs.com/graduates.

www.ubs.com/graduates



© UBS 2010. All rights reserved.

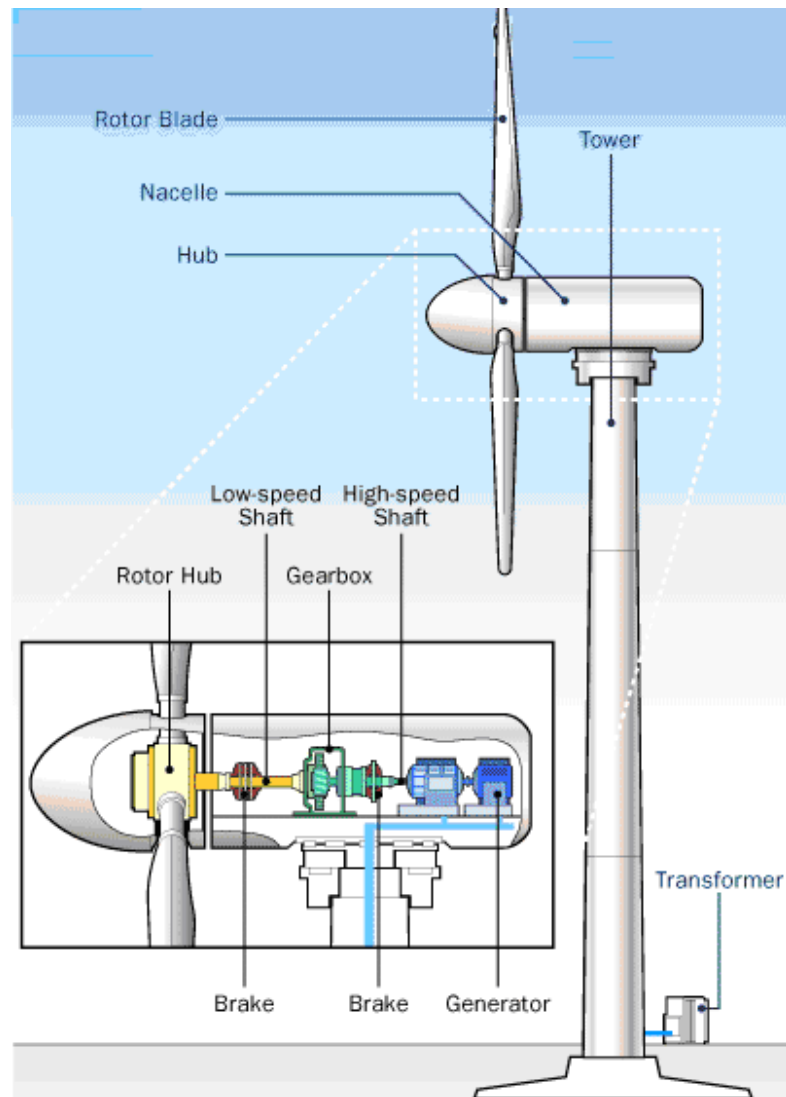

Figure 1.1 Energy conversions in a typical Wind Turbine.

Courtesy of: howStuffWorks.

From \ To	Mechanical	Electrical	Thermal	Chemical	Nuclear
Mechanical	Gear Nutcracker push mower	Electric generator	friction	x	
Electrical	Electric motor	Light bulb	Electric fire	Electrolysis	Particle accelerator
Thermal	Steam turbine	Thermo- couple	Heat exchanger	x	Fusion reactor
Chemical	jet engine Rocket	Battery fuel cell	Car engine Boiler	Intermediate reaction	x
Nuclear	x	x	Nuclear reactor	x	x

Table 1.1 Energy conversion matrix

1.4 Environmental Impact from fossil fuels

Coal, Oil and Natural gas have their relative merits in terms of availability, price and thermal performance. Table 1.3 below is constructed for comparison of the heat capacity, CO₂ and SO₂ production by the three fossil fuels. The 4th column is of particular importance in comparing all three fuels; it represents the quantity of carbon dioxide emitted for every unit of energy produced.

Coal produces the highest amount of Carbon dioxide for a given output of energy; then oil, then Natural gas which produces nearly half the emission of coal and a third less than that of oil.

The results displayed in table 1.3 for the production of CO₂ mass per unit energy compares well with data published by the UK government, Action on Energy, the values found in this chapter are lower than those quoted in the reference, the difference is that the calculations shown in this chapter were only concerned with the combustion process itself; there other knock on effect in the calculations when the life cycle of the fuel is considered, hence the addition of energy used to transport, process the fuel, and to include distribution losses.

Fuel	Calorific Value MJ/kg	CO ₂ kg / kg fuel	CO ₂ / Energy kg / MJ	SO ₂ kg / kg fuel
Coal	26	2.361	0.091	0.018
Oil	42	3.153	0.075	0.040
Natural Gas	55	2.750	0.050	0

Table 1.3 Environmental impacts of fossil fuels

Please click the advert



360°
thinking.

Deloitte.

© Deloitte & Touche LLP and affiliated entities.

Discover the truth at www.deloitte.ca/careers

1.5 Energy world-wide



The consumption of energy by humankind has evolved over the ages. It began with the invention of fire, man relied on wood burning to cook and to provide warmth and light for millions of years. As civilisation evolved, the needs for energy became greater and other sources were sought. In the long search, man discovered coal. Over the years coal provided much greater resource for energy, encouraging man to push its use into further applications.

A major leap in the nineteenth century was achieved by the discovery of oil in the Middle East. This unfortunate discovery eventually led to TWO World wars as the leading industrial nations attempted to dominate the world market and to secure the energy supply for their huge manufacturing industries. The oil crises due to the Arab-Israeli war in 1973 resulted in tripling of oil prices, this was a major shock for non producing countries, particularly in Europe, on one hand it has put tremendous increase on the energy consumer's budget;

The discovery of oil pushed the competition for manufacturing beyond the industrialised countries own borders. This competition for shares in the exports market put so much strain on the consumption of fossil fuel. Hubbert put foreword his caution when he published his famous curve (1956), Figure 1.2. It is clear that the oil reserves of the world are consumed unsustainably and will be exhausted within this century. Humans have to find a new source or sources of energy to replace oil.

However, on the positive side, the depletion of oil can be considered as a major advantage to humankind and the environment, it will force consumers to reduce the excessive consumption of energy, it will help man to review manufacturing processes and attempt to increase energy efficiency, and probably it has already pushed governments to search for newer sources of energy. Substantial funds are allocated for the research into renewable resources such as Hydropower, wind turbines and solar energy.

Energy consumption world-wide has continued to rise, it is estimated that in 1900, the world consumption was around 22 EJ and by 1960 it rose to 128 EJ; this reached 564 EJ in 2000.

The continued increase in population and the associated increase in manufacturing industry to cater for greater dependence of man on energy driven devices and the culture of multi-car ownership has put even greater importance for energy. It is interesting to note that the energy consumption for individuals have increased by 10 folds over the century mentioned above. This is another proof that we are becoming too excessive and becoming too dependant on energy far greater than we did before.

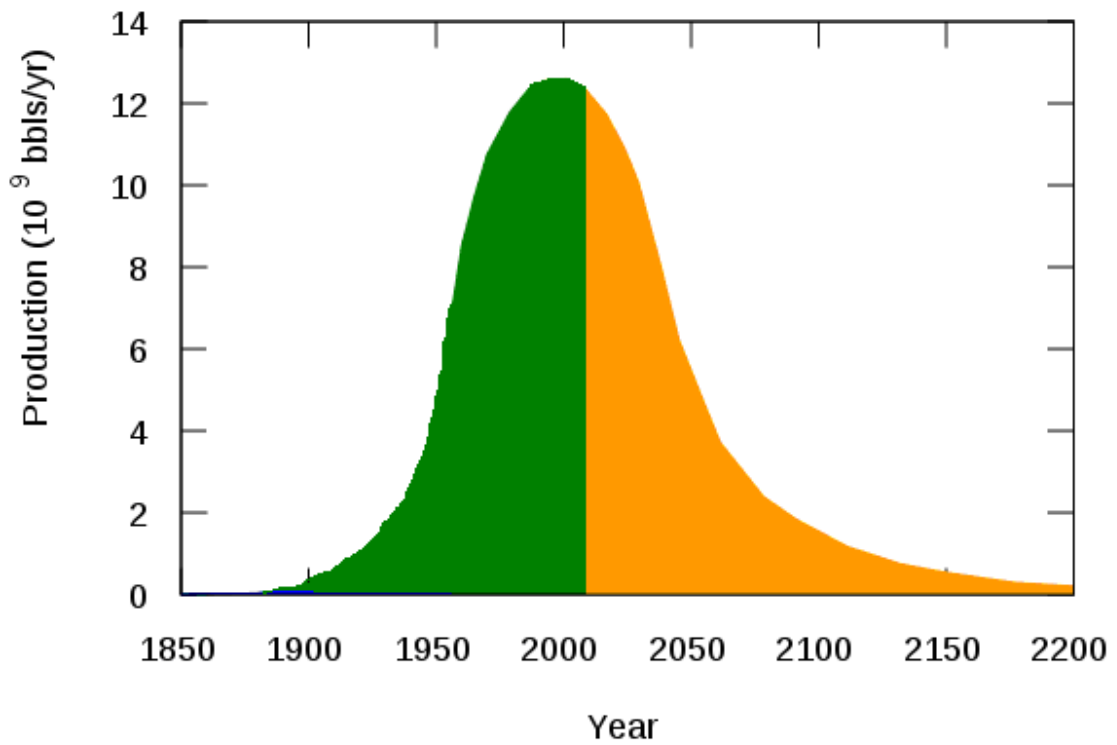

Figure 1.2 the first wake up call by Hubbert.

Courtesy of wikimedia.org

Please click the advert

Stafford
associates

Find your next education here!

Click here

bookboon.com/blog/subsites/stafford

2 Wind Energy

2.1 Introduction

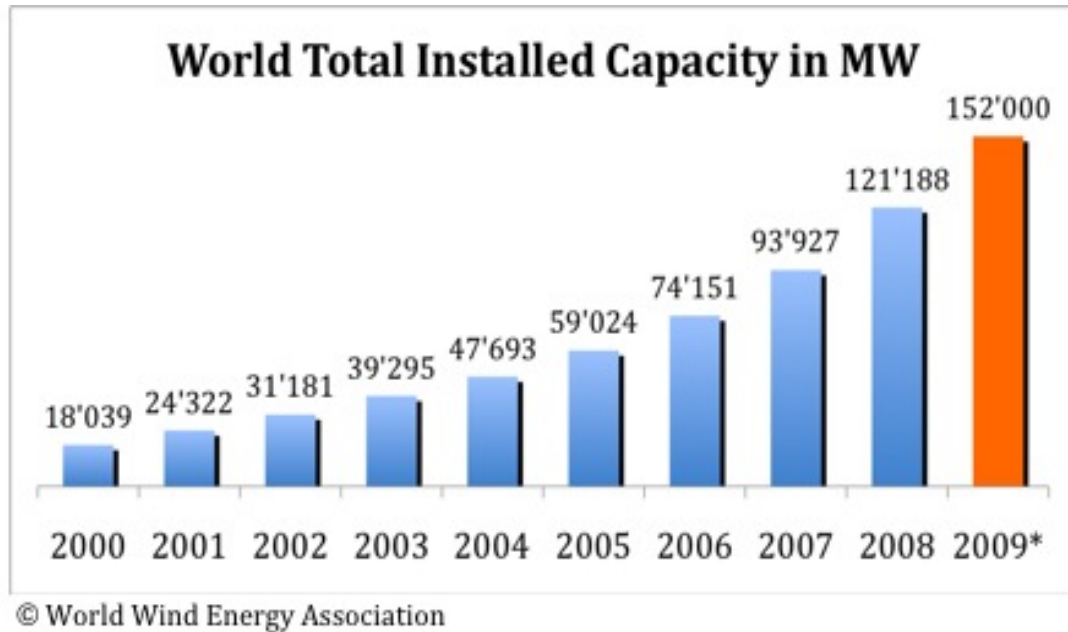

Figure 2.1 Wind Power developments

Courtesy of – <http://www.wwindea.org/>

According to BWEA, the British Wind Energy Authority, in the UK currently there are 2896 large Wind turbines with installed capacity of 4532 MW, sufficient to supply over 2.5 million homes (based on annual household energy consumption of 4.7 MWh).

Much attention has been paid recently to Renewables as a potential source of fuel. The rising oil price and the logistics in supplying fossil fuel to remote areas are the main drive to Renewables as well as the environmental incentive. In remote locations, stand-alone Renewable energy systems can be more cost-effective than extending a power line to the electricity grid. In addition, the environmental benefits under the current international concerns on global warming makes such project much more valuable and rewarding.

The growth of renewable energy sources also stimulates employment, the creation of new technologies and new skills.

The new Directive on renewable energy sets ambitious targets for all Member States, such that the EU will reach a 20% share of energy from renewable sources by 2020 and a 10% share of renewable energy specifically in the transport sector. It also improves the legal framework for promoting renewable electricity, requires national action plans that establish pathways for the development of renewable energy sources including bioenergy, creates cooperation mechanisms to help achieve the targets cost effectively and establishes the sustainability criteria for Biofuels. The new Directive should be implemented by Member States by early in 2010.

In a recent statement, Ed Miliband, UK Secretary of State for Energy and Climate change he spelled out the government strategy:

“Transforming the country into a cleaner, greener and more prosperous place to live is at the heart of our economic plans for 'building Britain’s future' and ensuring the UK is ready to take advantage of the opportunities ahead”.

By 2020:

- More than 1.2 million people will be in green jobs.
- 7 million homes will have benefited from whole house makeovers, and more than 1.5 million households will be supported to produce their own clean energy.
- Around 40 percent of electricity will be from low-carbon sources, from Renewables, nuclear and clean coal.
- We will be importing half the amount of gas that we otherwise would.
- The average new car will emit 40 percent less carbon than now.

2.2 Siting of Wind turbines

The placement or "siting" of wind systems is extremely important. In order for a wind turbine system to be effective, a relatively consistent wind-flow is required. Obstructions such as trees or hills can interfere with the rotors. Because of this, the rotors are usually placed on towers to take advantage of the stronger winds available higher up. Furthermore, wind speed varies with temperature, season, and time of day. All these factors must be considered when choosing a site for a wind-powered generator.

The amount of Wind Energy available at any location depends on two sets of factors:

- a. Climatic factors including: Time of day, Season, Geographic location, Topography, and Local weather.
- b. Mechanical factors including: Diameter of rotor, and Type of Turbine

Utility-scale wind farms must have access to transmission lines to transport energy. The wind farm developer may be obligated to install extra equipment or control systems in the wind farm to meet the technical standards set by the operator of a transmission line.



Figure 2.2 Wind farm, off shore, or on shore.

Please click the advert

An advertisement for IKEA featuring a central white text box with the text "It's only an opportunity if you act on it" and the URL "IKEA.SE/STUDENT". Surrounding the text box are several circular icons: a green one with "Reduce Reuse Recycle", a yellow one with "WORK WITH US", a pink one with "to gether ness", a blue one with "save water. shower together", and a blue one with "everyone deserves good design". There is also an icon of a red lamp. The IKEA logo is in the bottom left corner. A vertical copyright notice "© Inter IKEA Systems B.V. 2009" is on the right side.

It's only an opportunity if you act on it

IKEA.SE/STUDENT

IKEA

© Inter IKEA Systems B.V. 2009

2.3 Planning Constraints for wind turbines:

There is a number of planning related issues that may make it difficult for you to install a turbine on your site and it would be wise to ensure that you are not going to fall foul of any of these before proceeding.

- **Military installations.**
Avoid these installations, especially if it is an air force base or communication centres.
- **Proximity to built-up area.**
When housing estates are concerned, ideally consider a distance of at least 200m - 300m depending on the size of the turbine.
- **Designated areas or listed buildings.**
National Parks or Areas of Outstanding Natural Beauty are more difficult to satisfy the local planning officer to install a wind turbine on it or near it.

2.3.1 Steps to Planning and Building a Wind Farm

There are many stages of development before a wind turbine/farm can be approved and built. Once a site has been selected for its good overall potential, work begins on several main tasks:

- **Consultation with the local authority**
It is extremely important to contact the local authority in the area where the turbine is considered before committing any time or costs. Engage them early in the planning process, answer any questions and/or concerns that they might have, and keep an open dialogue with them throughout the whole development.
- **Consultation with the Public near the site**
The local community who are likely to be affected by the proposal must be met to present the project, solicit their feedback and seek their support. An advertisement in the local paper would be a good idea to inform the general public and invite them for a discussion and debate.
- **Land acquisition**
Early in the process, developers, if not already the owners themselves usually approach landowners to negotiate “option” agreements to use their land. As the project progresses, the developer will seek to convert the options into firm land lease agreements.
- **Wind Assessment**
Another very important step is assessing the wind resource. Scientists and engineers use meteorological masts to measure wind speed and other climatic conditions for at least one year. This data is then used to estimate how much energy the wind farm will produce. It is often assumed that this has to be carried out before any serious consideration is planned.

- **Wind Farm Design**

This is important if the project is a wind farm, Wind data is combined with topographical information to design the wind farm. Engineers use this data to model wind flow, turbine performance, sound levels and other parameters to optimize the location of the wind turbines. They also design the access roads, turbine foundations and local electric network, as well as the connection to the electricity grid.

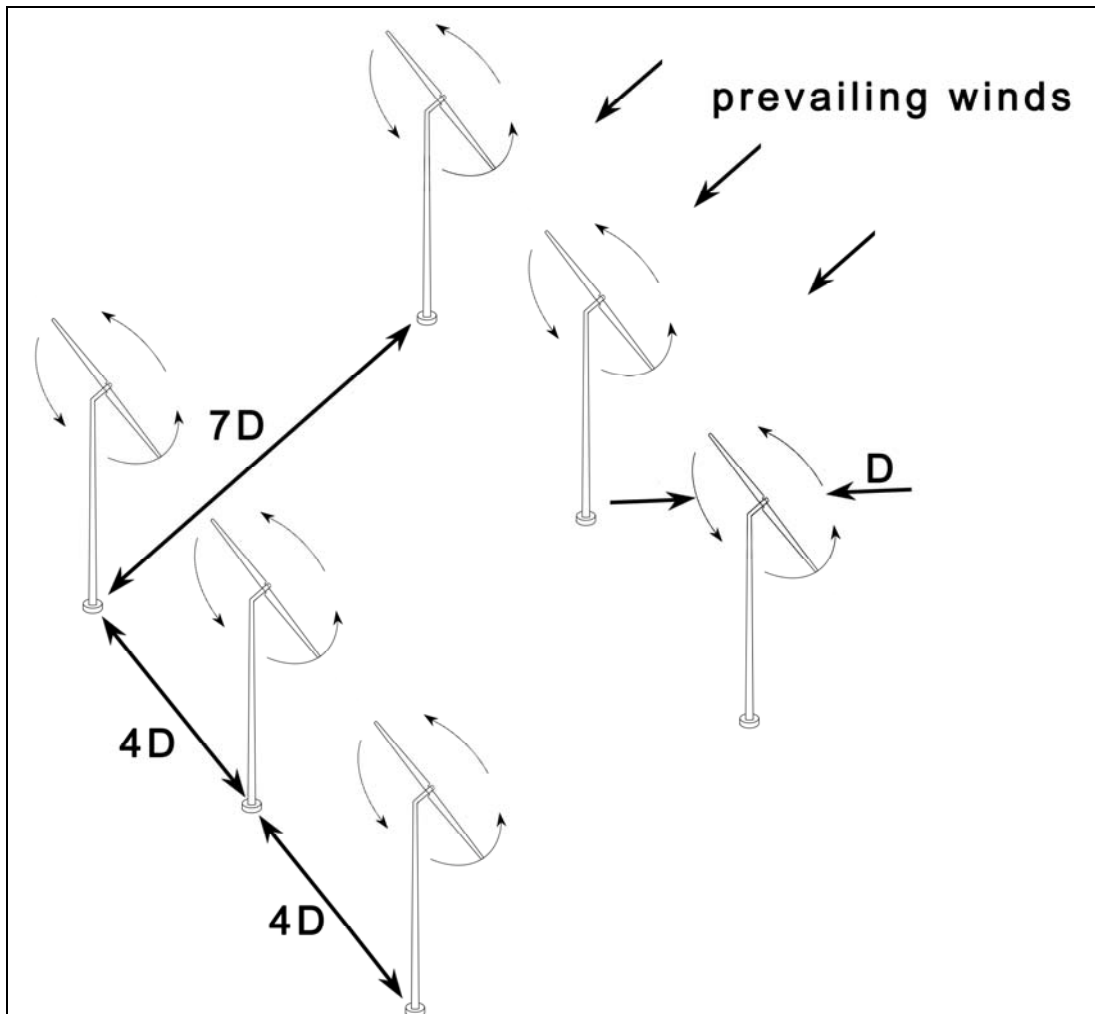

Figure 2.3 Wind farm optimal placement

- **Environmental Impact Assessment**

Environmental assessments are conducted to identify any impacts on landscape, plants and wildlife, soil and water, land use or other activities such as aviation and telecommunications. If negative impacts are identified, the design is adjusted to avoid or mitigate them.

- **Economic and Financial evaluation**

To prove the economic viability of the project in order to raise the funds to build the wind farm. On one hand, there is a need to estimate the cost of turbines and their installation, as well as roads, electrical system, operation and maintenance, etc. On the other hand, there is a need to estimate the income from the energy production of the wind farm over the lifetime of the project. If there is a net profit, the project has a chance to succeed.

- **Site Preparation**

Build access roads and clear the areas where turbines will be erected; then prepare the foundations; do the excavating, followed by installing the formworks and pouring concrete.

- **Construction**

The wind turbine parts are manufactured and pre-assembled into the main components at the factory then shipped to the wind farm site where the final assembly will take place. When all components have been received, the assembly can take place. A crane is used to erect the tower and install the nacelle and rotor with its hub and blades. On the ground, the electrical collection network is installed and connected to the grid through the substation.

- **Commissioning**

Finally, the wind turbine is tested, all components are calibrated on site and verified against the suppliers specifications, before becoming fully operational.

Please click the advert

YOUR CHANCE TO CHANGE THE WORLD

Here at Ericsson we have a deep rooted belief that the innovations we make on a daily basis can have a profound effect on making the world a better place for people, business and society. Join us.

In Germany we are especially looking for graduates as Integration Engineers for

- Radio Access and IP Networks
- IMS and IPTV

We are looking forward to getting your application!
To apply and for all current job openings please visit our web page: www.ericsson.com/careers

ericsson.
com



2.4 Wind Energy and the Environment

In this section, both the positive and negative aspects of wind energy will be discussed.

2.4.1 Positive environmental benefits of Wind energy

It must be stressed that wind energy involves no combustion or nuclear reaction, so it is pollution free. It is renewable and plentiful and free, and what is more it is available everywhere, especially in remote areas and often it is windier in mountains and near coastal areas. There are significant environmental benefits obtained from using a renewable energy device attributed to preventing the release of Green house gases associated with fossil fuels. The general equation for estimating the reduction in emitted gas is:

$$\text{Gas-emission reduction (in tonnes)} = A \times 0.8 \times h \times kG$$

Where

A is the rated capacity of the development in kW

h is the number of operational hours per year, = 8000 h

kG is the specific emitted gas constant.

Hence the following equations are used to predict environmental benefits from based on 1 kWe system:

$$\begin{aligned} \text{CO}_2 \text{ emission reduction (in tonnes)} &= 1 \times 0.8 \times 8000 \times 862 / 10^6 \\ &= 5.5 \end{aligned}$$

$$\begin{aligned} \text{SO}_2 \text{ emission reduction (in tonnes)} &= 1 \times 0.8 \times 8000 \times 9.9 / 10^6 \\ &= 0.063 \end{aligned}$$

$$\begin{aligned} \text{NO}_2 \text{ emission reduction (in tonnes)} &= 1 \times 0.8 \times 8000 \times 862 / 10^6 \\ &= 0.018 \end{aligned}$$

2.4.2 Negative Impacts of Wind energy

These issues are often raised, some are valid, some are opinion driven, and others could be due to personal preferences or biasness.

a. Noise

Wind turbines rely on the movement of the rotor affected by wind to rotate the generator and make electricity. Virtually everything with moving parts will make some sound, and wind turbines are no exception. Turbines are an established and well developed technology, and well designed wind turbines are generally quiet in operation, and compared to the noise of road traffic, trains, aircraft and construction activities, the noise from wind turbines is relatively low. Outside the nearest houses, which are at least half a mile away, and more often further, the sound of a wind turbine generating electricity is likely to be about the same level as noise of leaves rustling in a gentle breeze. This is similar to the sound level inside a typical living room with a gas fire switched on, or the reading room of a library or in an unoccupied, quiet, air-conditioned office.

Source/Activity	Indicative noise level dB (A)
Threshold of hearing	0
Rural night-time background	20-40
Quiet bedroom	35
Wind farm at 350m	35-45
Car at 40mph at 100m	55
Busy general office	60
Truck at 30mph at 100m	65
Pneumatic drill at 7m	95
Jet aircraft at 250m	105
Threshold of pain	140

Table 2.1 Comparative noise levels

There are two potential sources of noise related to wind turbines: the turbine blades passing through the air as the hub rotates, and the gearbox and generator in the nacelle. Noise from the blades is minimised by careful attention to the design and manufacture of the blades. The noise from the gearbox and generator is contained within the nacelle by sound insulation and isolation materials.

Preliminary recommendations from the Wind Turbine Noise Working Group, established by the DTI in the UK, are that turbine noise level should be kept to within 5 dB(A) of the average existing evening or night-time background noise level. A fixed low level of between 35 and 40 dB(A) may be specified when background noise is very low, ie. Less than 30 dB(A).

b. Bird-kill

This is a very emotionally charged subject. Bird conservationists tend to view wind turbines as death machines and refer to bloody bird corpses lying at the foot of turbine towers and entire species migrating from the areas surrounding wind farms.

Birds occasionally collide with wind turbines, as they do with other tall structures such as buildings. Detailed studies and monitoring following construction, at wind development areas indicate that this is a site-specific issue that will not be a problem at most potential wind sites. Also, wind's overall impact on birds is low compared with other human-related sources of avian mortality. See Figure 2.4

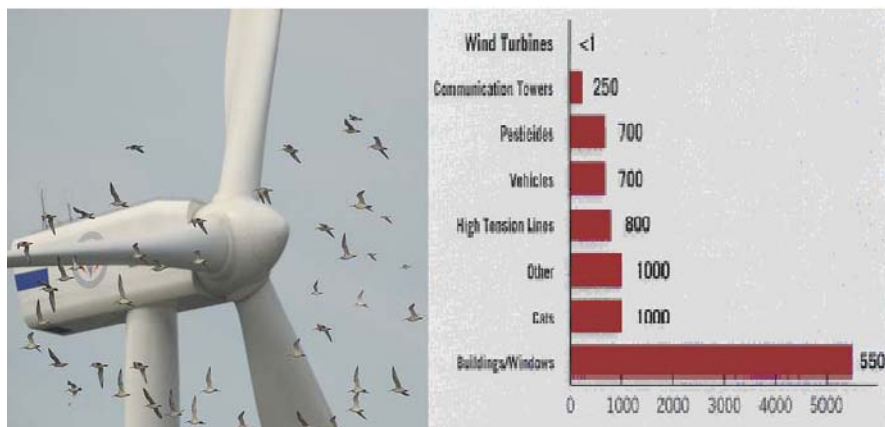

Figure 2.4 Causes of Bird-kill

I joined MITAS because
I wanted **real responsibility**

The Graduate Programme
for Engineers and Geoscientists
Maersk.com/Mitas

Please click the advert

Month 16
I was a construction supervisor in the North Sea advising and helping foremen solve problems

Real work
International opportunities
Three work placements

c. Visual impacts

Wind turbines are just normal structures to look at, just like trees, better looking than boiler chimneys.

In comparison to other energy developments, such as nuclear, coal and gas power stations or open cast coal mining, wind farms have relatively little visual impact. Wind farm developers recognise that visual impact can be a concern for neighbouring communities. Considerable effort is therefore committed to the planning stages in order to reduce the impact and gain their consent.

A number of national wind energy associations have established detailed best practice guidelines for the development of wind farms, including their visual impact.

Surveys of public opinion show that most people who live near wind developments find them less intrusive once they are operating than they might have feared beforehand. Other surveys, for instance in Scotland, have shown that there is no evidence that tourism is seriously affected by the presence of wind farms. The authors experience is the opposite to that, I found myself going to places never thought I would, for the simple reason to see how the wind turbines work and enjoy the view of clean energy machine.

Although a wind energy project can spread across a large total land area, it does not occupy all that space. Farming or leisure activities can still continue around the turbines. The European Wind Energy Association has estimated that the number of wind farms required to contribute 20% of Europe's electricity supply would take up only a few hundred square kilometres.

d. Shadow Flicker

is occasionally raised as an issue by some people. A wind turbine's moving blades can cast a moving shadow on a nearby residence, depending on the time of the year (which determines how low the sun is in the sky) and time of day. It is possible to calculate very precisely whether a flickering shadow will in fact fall on a given location near a wind farm, and how many hours in a year it will do so. Therefore, it should be easy to determine whether this is a potential problem.

e. Communication interference

Wind turbines, like all structures, can interfere with communication or radar signals when these signals are interrupted by the turbine structure or the rotor plane. Wind turbines can sometimes cause electromagnetic interference affecting TV and radio reception. Electromagnetic interference can be caused by near-field effects, diffraction, or reflection and scattering. Such interference can typically be mitigated by using satellite TV or wireless cable TV. Although instances of TV or radio interference are infrequent and typically straightforward to mitigate, the interaction of wind turbines and navigational or defence radar signals is the subject of considerable recent attention

A number of tools and practices are available to manage or mitigate the potential impact of wind turbine interference:

- Farm layout optimization, terrain masking, or reduction of the radar cross-section area may be sufficient to address identified interference problems.
- Coating equipment with absorbent or reflective materials to minimize the turbine's radar signature.
- Often the easiest and least costly approaches involve software optimization. Other options include installing post-processors or adding hardware (such as processors, transmitters, or receivers). When such changes alone are insufficient, more involved approaches can sometimes be implemented. These include deploying extra radars to cover the shadow spots, relocating radar installations to accommodate the new wind farms, or altering air traffic routes around new wind farms.

Even with these mitigation methods, there will be some proposed locations where wind turbines will cause disruptive radar interference. In such cases, wind projects would likely be unable to proceed at the proposed site.



Figure 2.5 “Not” a perfect place to site a wind farm.

3 Theory of Wind Energy

The principles concerned with converting the potential energy of fluids into useful power relies on three basic fundamentals: conservation of mass, energy and momentum, so it is useful to discuss these before examining the operation of wind turbines.

3.1 Conservation of Mass:

The *continuity equation* applies the principle of conservation of mass to fluid flow. Consider a fluid flowing through a fixed conduit having one inlet and one outlet as shown in Figure 3.1

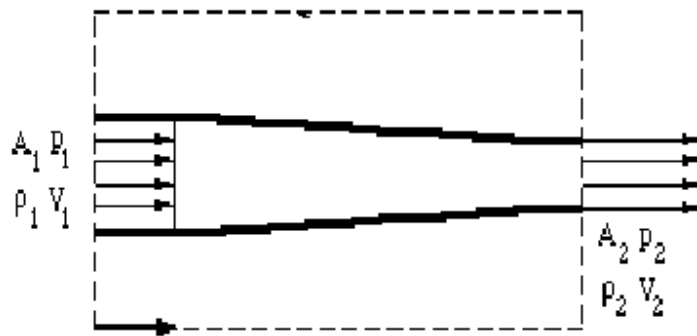



Figure 3.1 Conservation of mass of a fluid flowing in a duct/pipe

SIMPLY CLEVER

We will turn your CV into an opportunity of a lifetime



Do you like cars? Would you like to be a part of a successful brand? We will appreciate and reward both your enthusiasm and talent. Send us your CV. You will be surprised where it can take you.

Send us your CV on www.employerforlife.com



If the flow is *steady* i.e no accumulation of fluid within the control volume, then the rate of fluid flow at entry must be equal to the rate of fluid flow at exit for mass conservation. If the flow cross-sectional area A (m^2), and the fluid parcel travels a distance dL in time dt , then the volume flow rate (V_f , m^3/s) is given by:

$$V_f = A \cdot dL / dt$$

but since dL/dt is the fluid velocity (V , m/s) we can write: $V_f = V \times A$

The mass flow rate (m , kg/s) is given by the product of density and volume flow rate. Between any two points within the control volume, the fluid mass flow rate can be shown to remain constant:

$$\text{or} \quad \rho_1 A_1 V_1 = \rho_2 A_2 V_2 \quad (1)$$

3.2 Conservation of Energy:

Conservation of energy necessitates that the total energy of the fluid remains constant, however, there can be transformation from one form to another.

There are three forms of non-thermal energy for a fluid at any given point:-

The *kinetic energy* due to the motion of the fluid.

The *potential energy* due to the positional elevation above a datum.

The *pressure energy*, due to the absolute pressure of the fluid at that point.

If all energy terms are written in the form of the *head* (potential energy), ie in metres of the fluid, then conservation of energy principle requires that:

$$\left(\frac{p}{\rho g} + \frac{V^2}{2g} + z \right)_1 = \left(\frac{p}{\rho g} + \frac{V^2}{2g} + z \right)_2 \quad (2a)$$

This equation is known as the *Bernoulli equation* and is valid if the two points of interest 1 & 2 are very close to each other and there is no loss of energy.

In a real situation, the flow will suffer a loss of energy due to friction (h_L) and obstruction between stations 1 & 2, hence

$$\left(\frac{p}{\rho g} + \frac{V^2}{2g} + z \right)_1 = \left(\frac{p}{\rho g} + \frac{V^2}{2g} + z \right)_2 + h_L \quad (2b)$$

3.3 Conservation of Momentum

Consider a duct of length L , cross-sectional area A_c , surface area A_s , in which a fluid of density ρ , is flowing at mean velocity V . The forces acting on a segment of the duct are that due to pressure difference and that due to friction at the walls in contact with the fluid.

If the acceleration of the fluid is zero, the net forces acting on the element must be zero, hence

$$(p_1 - p_2) \cdot A_c - (f \rho V^2/2) \cdot A_s = 0$$

or
$$p_1 - p_2 = \rho g h_f$$

where
$$h_f = f \cdot (A_s/A_c) \cdot V^2/2g$$

For a pipe
$$A_s/A_c = \pi D L / \pi D^2/4 = 4L/D$$

hence
$$h_f = (4 fL/D) \cdot V^2/2g \quad (3)$$

This is known as Darcy formula.

The value of the friction factor (f) depends mainly on two parameters namely the value of the Reynolds number and the surface roughness.

The Reynolds number is defined in terms of the density, velocity of flow, diameter and the dynamic viscosity as follows:

$$Re = \frac{\rho \cdot V \cdot D}{\mu} \quad (4)$$

For **laminar** flow (ie $Re < 2000$),

$$f = \frac{16}{Re} \quad (5a)$$

While for a **smooth** pipe with **turbulent** (i.e. $Re > 4000$) flow,

$$f = \frac{0.079}{Re^{0.25}} \quad (5b)$$

For $Re > 2000$ and $Re < 4000$, this region is known as the critical zone and the value of the friction factor is certain.

In the turbulent zone, if the surface of the pipe is not perfectly smooth, then the value of the friction factor has to be determined from the **Moody diagram** (see overleaf). The **relative roughness** is the ratio of the average height of the surface projections on the inside of the pipe (k) to the pipe diameter (D). In common with Reynolds number and friction factor this parameter is dimensionless.

3.4 Ideal Wind Power calculations:

In Theory, Wind power (P) is calculated by the following general equation (the proof for which will be derived in the following section):

$$P = C_p * \frac{1}{2} \rho * A * V^3 \quad (6)$$

Where

- C_p is the power coefficient
- ρ is the density of the oncoming air
- A swept area of the rotor
- V is the velocity of the wind

The actual power is further reduced by two more inefficiencies, due to the gear box losses and the generator efficiency.

Please click the advert

Are you remarkable?

Win one of the six full
tuition scholarships for
International MBA or
MSc in Management

**REGISTER
NOW**

[www.Nyenrode
MasterChallenge.com](http://www.NyenrodeMasterChallenge.com)

 **NYENRODE**
BUSINESS UNIVERSITEIT
A REWARD FOR LIFE

NYENRODE 
MASTER CHALLENGE
2013 powered by DutchNews.nl

The value of the ideal power is limited by what is known as Betz coefficient with a value of $C_p = 0.59$ as the highest possible conversion efficiency possible.

In practice, most wind turbines have efficiencies well below 0.5, depending on the type, design and operational conditions.

In the operational output range, wind power generated increases with wind speed cubed. In other words, at a wind speed of 5 m/s, the power output is proportional with 5 cubed = 125, whereas at a wind speed of 10 m/s, the power output is proportional to 1000. This shows that doubling the speed from 5 to 10 m/s resulted in a power increase of 8 folds. This highlights the importance of location when it comes to install wind turbines. The effect of the rotor diameter affects the power output in a square manner, i.e., doubling the rotor diameter results in increasing the power output by four times.

On the other hand, since power generated is related to wind speed by a cubic ratio. That means if your turbine is rated at producing 1KW at 12m/s then it will produce 125W at 6m/s and 15W at 3m/s.

3.3.1 Theory of Wind Turbines

A windmill extracts power from the wind by slowing down the wind. At stand still, the rotor obviously produces no power, and at very high rotational speeds the air is more or less blocked by the rotor, and again no power is produced.

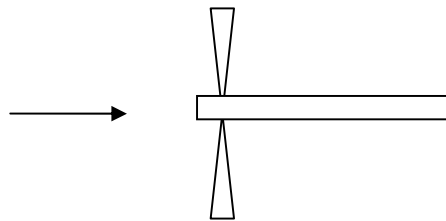

Figure 3.2 Ideal Wind Energy Theory.

The Power produced (P_{kin}) by the wind turbine is the net kinetic energy change across the wind turbine (from initial air velocity of V_1 to a turbine exit air velocity of V_2) is given as:

$$P_{kin} = \frac{1}{2} \rho m [V_1^2 - V_2^2] \quad (7)$$

The mass flow rate of wind is given by the continuity equation as the product of density, area swept by the turbine rotor and the approach air velocity as:

$$m = \rho * A * V_a \quad (8)$$

Hence the power becomes:

$$P_{\text{kin}} = \frac{1}{2} \rho A V_a [V_1^2 - V_2^2] \quad (9)$$

Since the rotor speed is the average speed (V_a) between inlet and outlet:

$$V_a = \frac{1}{2} [V_1 + V_2] \quad (10)$$

Hence, the power is

$$\begin{aligned} P_{\text{kin}} &= (1/2) * \rho * A * (V_1 + V_2)/2 * [(V_1)^2 - (V_2)^2] \\ &= (1/4) * \rho * A * [V_1^3 - V_2^3 - V_1 * V_2^2 + V_1^2 * V_2] \\ &= (1/4) * \rho * A * V_1^3 * [1 - (V_2/V_1)^3 - (V_2/V_1)^2 + (V_2/V_1)] \end{aligned} \quad (11)$$

To find the maximum power extracted by the rotor, differentiate equation 11 with respect to V_2 and equate it to zero

$$dP_{\text{kin}} / dV_2 = 1/4 * \rho * A * (-3 * V_2^2 - 2 * V_1 * V_2 + V_1^2) = 0 \quad (12)$$

Since the area of the rotor (A) and the density of the air (ρ) cannot be zero, the expression in the bracket of equation 12 has to be zero. Hence, the quadratic equation becomes:

$$(3V_2 - V_1)(V_2 + V_1) = 0$$

Since $V_2 = -V_1$ is unrealistic in this situation, there is only one solution, equation 12 yields:

$$V_2 = \frac{1}{3} V_1 \quad (13)$$

Substitution of equation 13 into equation 11 results in:

$$P_{\text{kin}} = (0.5925) * \frac{1}{2} [\rho * A * V_1^3] \quad (14)$$

The theoretical maximum fraction of the power in the wind which could be extracted by an ideal windmill is, therefore the fraction 0.5925 is called the *Betz Coefficient*. Because of aerodynamic imperfections in any practical machine and of mechanical losses, the power extracted is less than that calculated above. Figure 3.7 demonstrates the effect of wind turbine design implications on the resulting power that can be harnessed from the incoming wind. Efficient wind turbines depend on the production of that optimum speed ratio giving the maximum or near the maximum power possible.

Equation 14 clearly shows that:

- The power is proportional to the density (ρ) of the air which varies slightly with altitude and temperature
- The power is proportional to the area (A) swept by the blades and thus to the square of the radius (R) of the rotor; and
- the power varies with the cube of the wind speed (V^3). This means that the **power increases eightfold if the wind speed is doubled**. Hence, one has to pay particular attention in site selection.

3.3.2 Distinction between rated and actual power output of the turbine

The world's largest wind turbine generator has a rotor blade diameter of 126 metres and is located on offshore, at sea-level and so we know the air density is 1.2 kg/m^3 . The turbine is rated at 5MW in 30mph (14m/s) winds,

$$\begin{aligned} \text{Rotor Swept area } A &= (\pi \cdot 126^2)/4 = 12469 \text{ m}^2 \\ \text{Wind Power} &= 0.5 \times A \times \rho \times V^3 \\ &= 0.5 \times 12469 \times 1.2 \times (14)^3 = 20.5 \text{ MW} \end{aligned}$$

Please click the advert

Budget-Friendly. Knowledge-Rich.

The Agilent InfiniiVision X-Series and 1000 Series offer affordable oscilloscopes for your labs. Plus resources such as lab guides, experiments, and more, to help enrich your curriculum and make your job easier.









Scan for free Agilent iPhone Apps or visit qrs.ly/po20pli

See what Agilent can do for you.

www.agilent.com/find/EducationKit

© Agilent Technologies, Inc. 2012 u.s. 1-800-829-4444 canada: 1-877-894-4414

Anticipate — Accelerate — Achieve



Agilent Technologies

Why is the power of the wind (20MW) so much larger than the rated power of the turbine generator (5MW)?

The answer lies in the fact that the Betz limit and inefficiencies in the system seriously absorbs over 60% of the apparent power.

There are two further factors to be considered when estimating the power output from a turbine, the first is the mechanical transmission and the second is the generator's efficiency, both of which are less than unity, hence the real power is proportionately less than the ideal value.

The capacity factor, Cf. Assuming a 5 kW wind turbine generates annually 10 MWh, if that same installation had run – theoretically – 24 hours a day and 365 days a year at full load, it would have generated 43.8 MWh. The capacity factor (Cf) is $10/43.8 = 0.23$. Typical values for Cf between 0.2 and 0.4 in the united kingdom, depending on the exact location.

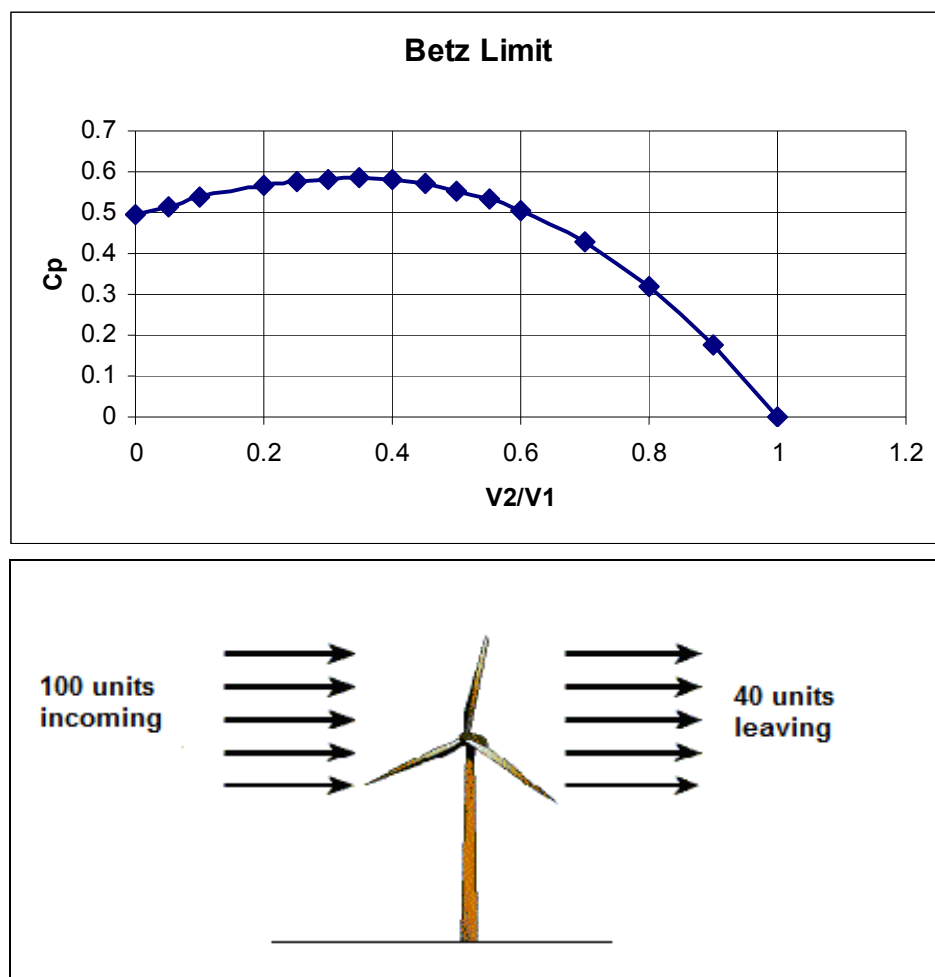

Figure 3.3 Betz Limit on wind energy efficiency and its Implications.

4 Wind Turbines types and components

4.1 Types of Wind Turbines

There are mainly two types of wind turbine: horizontal axis and vertical axis. The horizontal axis wind turbine (HAWT) and the vertical axis wind turbine (VAWT) are classified or differentiated by the axis of rotation the rotor shafts.

Horizontal Axis Wind Turbines - Horizontal axis wind turbines, also known as HAWT type turbines have a horizontal rotor shaft and an electrical generator which is both located at the top of a tower.

Vertical Axis Wind Turbines - abbreviated as VAWTs, are designed with a vertical rotor shaft, a generator and gearbox which are placed at the bottom of the turbine, and a uniquely shaped rotor blade that is designed to harvest the power of the wind no matter which direction is it blowing.

The first is the Darrieus wind turbine, which is designed to look like a modified egg beater. These turbines have very good efficiency, but poor reliability due to the massive amount of torque which they exert on the frame. Furthermore, they also require a small generator to get them started.



Figure 4.1 Wind Turbines, Some types

<http://www.educypedia.be/education/>

4.2 Components of a Wind Turbine

Wind turbine usually has six main components: the rotor, the gearbox, the generator, the control and protection system, the tower and the foundation. These main components can be seen in figure 4.2.

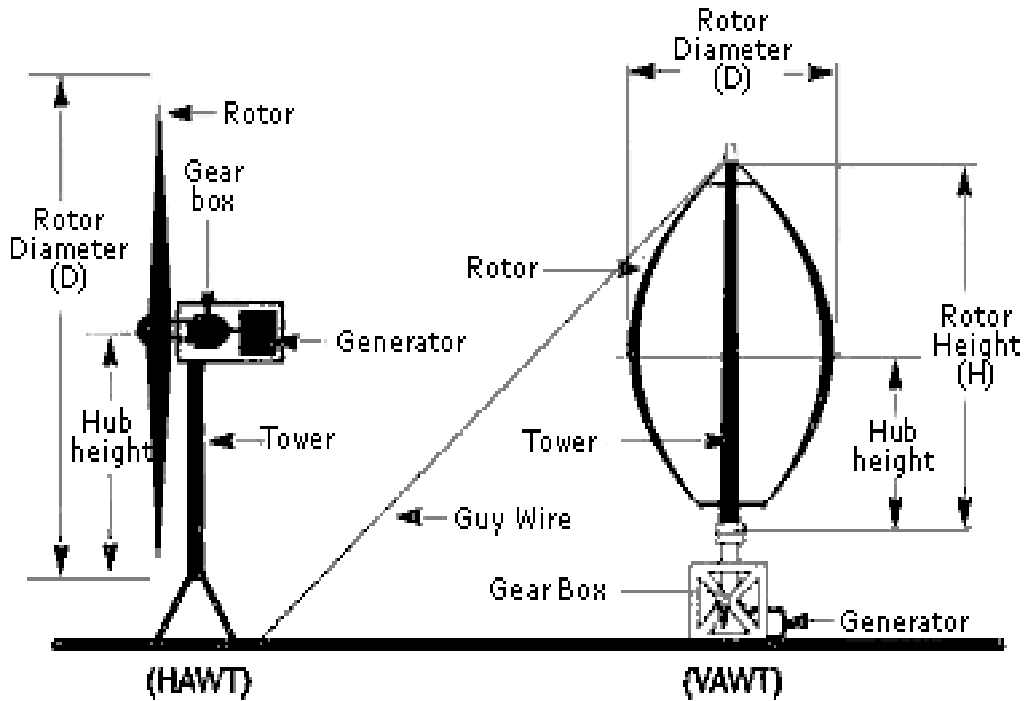

Figure 4.2 Wind Turbine components

Courtesy of National Instruments Corporation, USA.

Please click the advert

Question:
 What do Skype and Spotify have in common with color screen graphics and the computer mouse?
 –They are all Swedish inventions.

STUDYINSWEDEN.SE



Be innovative. Study in Sweden

Rotor - The rotor is an elegant aerofoil shaped blades which take the wind and aerodynamically converts its kinetic energy into mechanical energy through a connected shaft.

Gearbox - The gearbox alters the rotational velocity of the shaft to suit the generator.

Generator - The generator is a device that produces electricity when mechanical work is given to the system.

Control and Protection System - The protection system is like a safety feature that makes sure that the turbine will not be working under dangerous condition. This includes a brake system triggered by the signal of higher wind speeds to stop the rotor from movement under excessive wind gusts.

Tower - The tower is the main shaft that connects the rotor to the foundation. It also raises the rotor high in the air where we can find stronger winds. With horizontal axis wind turbines, the tower houses the stairs to allow for maintenance and inspection.

Foundation - The foundation or the base supports the entire wind turbine and make sure that it is well fixed onto the ground or the roof for small household wind turbines. This is usually consists of a solid concrete assembly around the tower to maintain its structural integrity.

In addition to the main components of a wind turbine, a wind energy generation system is shown in Figure 4.2, incorporating a charge controller, Battery and inverter so that the electricity is converted for use by house appliances and lights.



Figure 4.3 Wind Energy System

<http://www.inverter-china.com/>

4.3 Relationship between Wind speed and Rotor speed

The Tip Speed Ratio - (often known as the tsr) is of vital importance in the design of wind turbine generators. If the rotor of the wind turbine turns too slowly, most of the wind will pass undisturbed through the gap between the rotor blades. Conversely if the rotor turns too quickly, the blurring blades will appear like a solid wall to the wind. Therefore, wind turbines are designed with optimal tip speed ratios to extract as much power out of the wind as possible.

The optimum tip speed ratio depends on the number of blades in the wind turbine rotor. The fewer the number of blades, the faster the wind turbine rotor needs to turn to extract maximum power from the wind. A two-bladed rotor has an optimum tip speed ratio of around 6, a three-bladed rotor around 5, and a four-bladed rotor around 3. Figure 4.4 show some of the common Wind turbines and their respective efficiency against tip speed ratio (tsr).

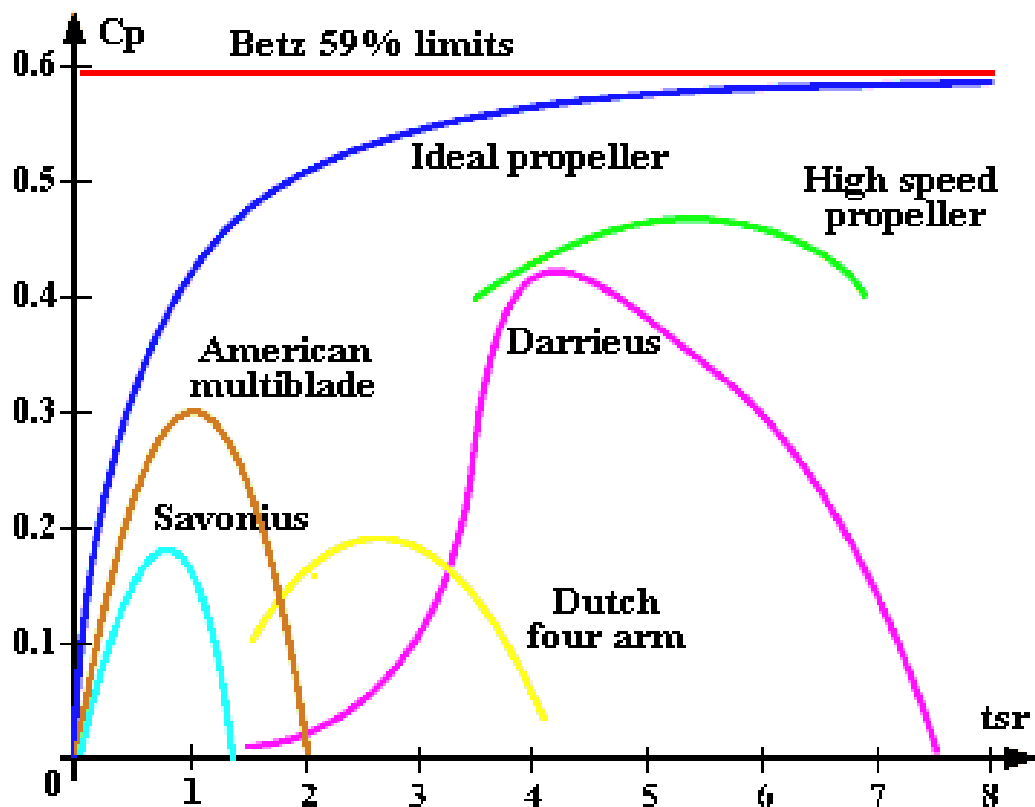

Figure 4.4 Typical Wind turbine efficiencies

Courtesy of <http://www.windturbine-analysis.netfirms.com/>

5 Wind Energy Measurements

There are four measurements associated with wind energy, the measurements of electrical signals including voltage, current or collectively electrical power, wind turbine rotational speed and the wind speed.

5.1 Electrical measurements

In order to determine electrical energy output, it is necessary to be able to measure it either directly as energy in kWh, or indirectly by measuring the voltage, current of the generated output of the wind turbine.

Quantity	Symbol	Unit of measurement	Unit abb.
Current	I	Amp	A
Voltage	V	Volt	V
Resistance	R	Ohm	Ω
Power/Energy	E	Watt	W

Table 5.1 Electrical Measurements

Please click the advert

With us you can
shape the future.
Every single day.

For more information go to:
www.eon-career.com

Your energy shapes the future.

e.on

5.1.1 Ohms Law

Ohm's law states that the current (I) through a conductor between two points is proportional to the potential difference (V) and inversely proportional to the resistance (R).

$$V = I \cdot R \quad (15)$$

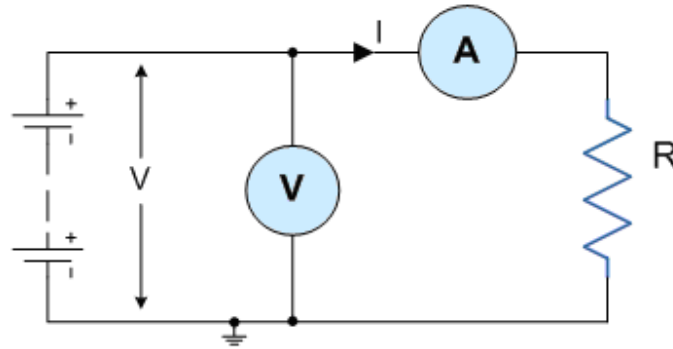

Figure 5.1 Ohms Law

5.1.2 Electrical Power

Electrical power (E) is the amount of energy produced.

The unit of measurement of Power being the **Watt (W)** with prefixes used to denote **milliwatts** (mW = 10^{-3} W) or **kilowatts** (kW = 10^3 W).

By using Ohm's law and substituting for V (volts) , I (amps) and R (Ω)the formula for electrical power, E (watts) can be found as:

$$E = V \times I \quad (16a)$$

$$E = V^2 \div R \quad (16b)$$

$$E = I^2 \times R \quad (16c)$$

5.1.3 Alternating Current Power

As in the case with DC power, the instantaneous electric power in an AC circuit is given by

$$E = VI, \quad (17)$$

But these quantities are continuously varying. Almost always the desired power in an AC circuit is the average power, which is given by

$$E_{avg} = VI \cos\phi \quad (18)$$

Where ϕ is the phase angle between the current and the voltage and where V and I are understood to be the effective or rms values of the voltage and current, see Figure 5.2. The term $\cos \phi$ is called the "power factor" for the circuit, a power factor of one or "unity power factor" is the goal of any electric utility company since if the power factor is less than one, they have to supply more current to the user for a given amount of power use. In so doing, they incur more line losses. They also must have larger capacity equipment in place than would be otherwise necessary.

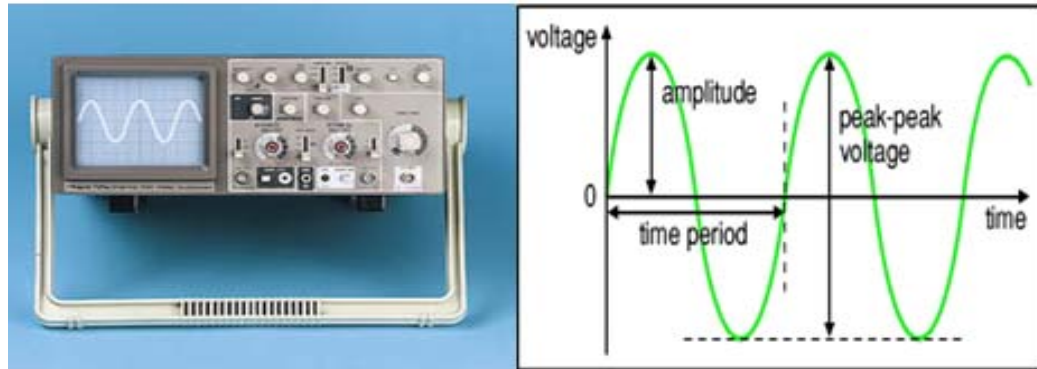

Figure 5.2 Resistive AC circuit

The difference between the maximum and minimum values is called peak-to-peak voltage (V_{pp}) and is twice the peak Voltage (V_p). The RMS voltage. (V_{rms}) is related to the peak voltage as:

$$V_{rms} = 0,707 \times V_p. \quad (19)$$

Circuit currents and voltages in AC circuits are generally stated as root-mean-square or rms values rather than by quoting the maximum values. The root-mean-square for a current is defined by

$$I_{rms} = \sqrt{I_{ave}^2} \quad (20)$$

That is, you take the square of the current and average it, then take the square root. When this process is carried out for a sinusoidal current

$$[I_m^2 * \sin^2(\omega.t)]_{ave} = \frac{I_m^2}{2}$$

hence

$$I_{rms} = \sqrt{I_{ave}^2} = \frac{I_m}{\sqrt{2}} \quad (21)$$

Since the AC voltage is also sinusoidal, the form of the rms voltage is the same. These rms values are just the effective value needed in the expression for average power:

$$E_{av} = \frac{V_m * I_m}{2} * \cos(\phi) = V_{rms} * I_{rms} * \cos(\phi) \quad (22)$$

Since the voltage and current are both sinusoidal, the power expression can be expressed in terms of the squares of sine or cosine functions, and the average of a sine or cosine squared over a whole period is = 1/2.

5.1.4 Electrical Measurements

Energy related measurements concerned with electricity production and consumption are usually derived from three elements namely: the electrical current, voltage and resistance of the load. These three variables are directly linked with the energy or power consumption of the load and hence it is common to see a single meter combining these to give a direct reading of the energy consumption.

Multimeters are very useful test instruments. By operating a multi-position switch on the meter they can be quickly and easily set to be a **voltmeter**, an **ammeter** or an **ohmmeter**. Two devices can be used to measure the electrical measurements: analog and digital multimeters as shown below in Figure. 5.3.

Please click the advert

Nido

Luxurious accommodation

Central zone 1 & 2 locations

Meet hundreds of international students

BOOK NOW and get a £100 voucher from voucherexpress

Nido Student Living - London

Visit www.NidoStudentLiving.com/Bookboon for more info.

+44 (0)20 3102 1060



Figure 5.3 Digital and Analog Multimeters

Courtesy of <http://www.kpsec.freeuk.com/multimtr.htm>

As far as power is concerned, the most common unit of power consumption measurement on the electricity meter is the kilowatt hour, which is equal to the amount of energy used by a load of one kilowatt over a period of one hour, or 3,600,000 joules. Some electricity companies use the SI mega joule instead. Modern electricity meters operate by continuously measuring the instantaneous voltage (volts) and current (amperes) and finding the product of these to give instantaneous electrical power (watts) which is then integrated against time to give energy used (joules, kilowatt-hours etc). The meters fall into two basic categories, electromechanical and electronic, as shown in Figure. 5.4.

The **mechanical electricity meter** has every other dial rotating counter-clockwise.

The most common type of electricity meter is the Thomson or electromechanical induction watt-hour meter, invented by Elihu Thomson in 1888. it work by counting the revolutions of an aluminium disc which is made to rotate at a speed proportional to the power. The metallic disc is acted upon by two coils. One coil is connected in such a way that it produces a magnetic flux in proportion to the voltage and the other produces a magnetic flux in proportion to the current.

A modern **digital electronic wattmeter/energy meter** samples the voltage and current thousands of times a second. The average of the instantaneous voltage multiplied by the current is the true power. The true power divided by the apparent volt-amperes (VA) is the power factor. A computer circuit uses the sampled values to calculate RMS voltage, RMS current, VA, power (watts), power factor, and kilowatt-hours. The simple models display that information on LCD. More sophisticated models retain the information over an extended period of time, and can transmit it to field equipment or a central location.



Figure 5.4 Measurement of Power

Courtesy of <http://en.wikipedia.org/wiki/>

5.2 Velocity and flow measured by Anemometers

Wind speed is the most important factor directly proportional to the power output of a wind turbine.

Various types of anemometer are used to measure the velocity, usually of air.

5.2.1 The 'cup type' air speed measurement

(Figure 5.5) is used for free air and has hemispherical cups on arms attached to a rotating shaft. The shape of the cups gives a greater drag on one side than the other and results in a speed of rotation approximately proportional to the air speed. Velocity is found by measuring revolutions over a fixed time.

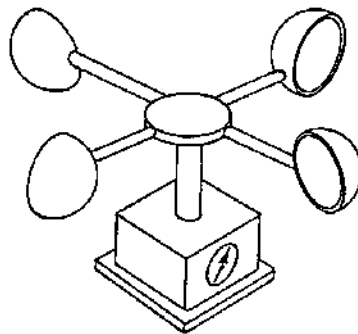

Figure 5.5 Cup Type Anemometer

5.2.2 The 'vane anemometer'

(Figure 5.6) has an axial impeller attached to a handle with extensions and an electrical pick-up which measures the revolutions. A meter with several ranges indicates the velocity.

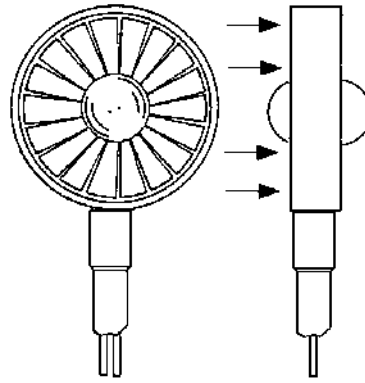

Figure 5.6 Vane Anemometer

Please click the advert

Brain power



By 2020, wind could provide one-tenth of our planet's electricity needs. Already today, SKF's innovative know-how is crucial to running a large proportion of the world's wind turbines.

Up to 25 % of the generating costs relate to maintenance. These can be reduced dramatically thanks to our systems for on-line condition monitoring and automatic lubrication. We help make it more economical to create cleaner, cheaper energy out of thin air.

By sharing our experience, expertise, and creativity, industries can boost performance beyond expectations. Therefore we need the best employees who can meet this challenge!

The Power of Knowledge Engineering

Plug into The Power of Knowledge Engineering.
Visit us at www.skf.com/knowledge



5.2.3 The 'hot-wire' anemometer'

(Figure 5.7) is a probe terminating in an extremely small heated wire element when subjected to a fluid stream it cools to an extent, which depends on the velocity of the fluid passing. The resulting change in resistance of the element is measured by a bridge circuit and is related to velocity by calibration.

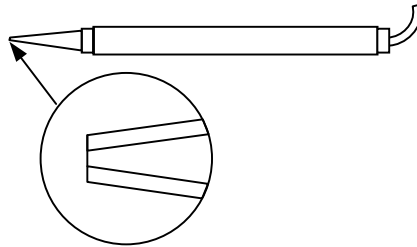

Figure 5.7 Hot-Wire Anemometer

5.3 Measurement of speed of rotation

The following methods are used to measure the speed of rotation of an object: -

- Mechanical Tachometer
- Digital Tachometer
- Stroboscopes
- Magnetic Field Angular Position Sensors
- Wheel Encoder

The choice of technique used for measurement is governed by the application range considered, degree of accuracy required, type of installation and original cost. In this section each type will be discussed and an overview of the importance of time measurement will also be discussed.

5.3.1 Mechanical Tachometer

This type of tachometer is a linkage of shafts, gears and rotating weights. When the input shaft which is seen horizontal rotates the vertical shaft it also rotates the weights attached to it which are hinged and free to move inward and outwards. The movement of these flyweights rotates a pointer which is calibrated to give the speed in desired units such as RPM.

Two main drawbacks of this are that the mechanical weights have inertia and hence not very accurate and secondly it does not give an indication of the direction of rotation.

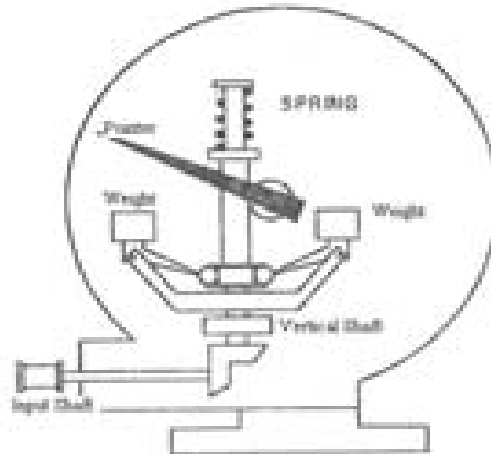

Figure 5.8 Mechanical Tachometer

Courtesy of <http://www.brighthub.com/>

5.3.2 Electrical Tachometers

This type of tachometer could be as simple as a DC or AC generator that can determine the speed of shaft rotation by the amount of voltage the generator produces or the frequency of the output signal. The magnitude of the generator voltage and the frequency of the generated voltage will increase proportionally with speed. Frequency can also be measured by a photocell tachometer. The number of pulses produced by the photocell will increase as the speed of the shaft rotation increases.

The rotating field and the toothed rotor tachometers produce a waveform and the photocell uses a rotating disk that has a number of windows in it. A light source is positioned so that it will shine light through each window in the disk to a photocell detector as the disk spins. The disk is connected to the tachometer shaft, so when it turns the windows line up with the photocell and the photocell produces a pulse when it is struck by light. In each of these types of tachometers a pulse stream is produced and it is proportional to the speed of the tachometer shaft.



Figure 5.9 Digital Tachometer

Courtesy of <http://www.vaishika.com/>

5.3.3 Stroboscope

Also known as the “**strobe**”, is an instrument used to make a cyclically moving object appear to be slow-moving, or stationary. The principle is used for the study of rotating, reciprocating, oscillating or vibrating objects. Machine parts and vibrating strings are common examples.

In electronic versions, the perforated disc is replaced by a lamp capable of emitting brief and rapid flashes of light. The frequency of the flash is adjusted so that it is an equal to, or a unit fraction below or above the object's cyclic speed, at which point the object is seen to be either stationary or moving backward or forward, depending on the flash frequency.



Figure 5.10 Stroboscope

Courtesy of <http://www.accesscontrolsales.com/>

In order to make a measurement, a mark is made on the object when it is stationary, and the object is spun up to speed. The oscillator is set to a low frequency to start with, and the LED is shone at the object where the mark is. At first, the mark will appear at random points around the object

When it is stationary, the LED is flashing at the same frequency as the object is rotating. Since the frequency is known, the rotational speed is also known, and can be stated in RPM using the formula:

$$\text{RPM} = 60 \times f_{\text{strobe}}$$

5.3.4 Magnetic Field Angular Position Sensors

These are similar shaft encoders, with one exception. They are capable of measuring the angle direction of a magnetic field from a magnet with $<0.07^\circ$ resolution. The advantages of measuring field direction versus field strength include: insensitivity to the temperature coefficient of the magnet, less sensitivity to shock and vibration, and the ability to withstand large variations in the gap between the sensor and magnet.

These sensors may be operated below 3 volts with a bandwidth response of 0-5 MHz. Output is a typical Wheatstone bridge permitting balanced output signals for noise immunity.

The main application of this sensor is to determine the angular position of a rotary axis. In this case, a permanent magnet is fixed on the engine axis just above the sensor. This magnet generates a directional magnetic field parallel to the surface of the sensor (Figure 5.11). This field works as a contactless interface between the orientation of the axis and the sensor.

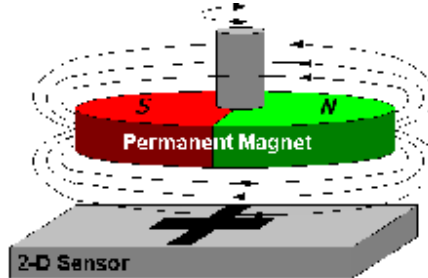

Figure 5.11 The permanent magnet speed sensor.

Please click the advert

Are you considering a European business degree?

LEARN BUSINESS at university level. We mix cases with cutting edge research working individually or in teams and everyone speaks English. Bring back valuable knowledge and experience to boost your career.

MEET a culture of new foods, music and traditions and a new way of studying business in a safe, clean environment – in the middle of Copenhagen, Denmark.

ENGAGE in extra-curricular activities such as case competitions, sports, etc. – make new friends among CBS' 18,000 students from more than 80 countries.





See what we look like and how we work on cbs.dk



5.3.5 Wheel encoder

Figure 5.12 shows an example of a typical encoder wheel. The resolution of the encoder wheel is determined by the number of cycles or complete phases.

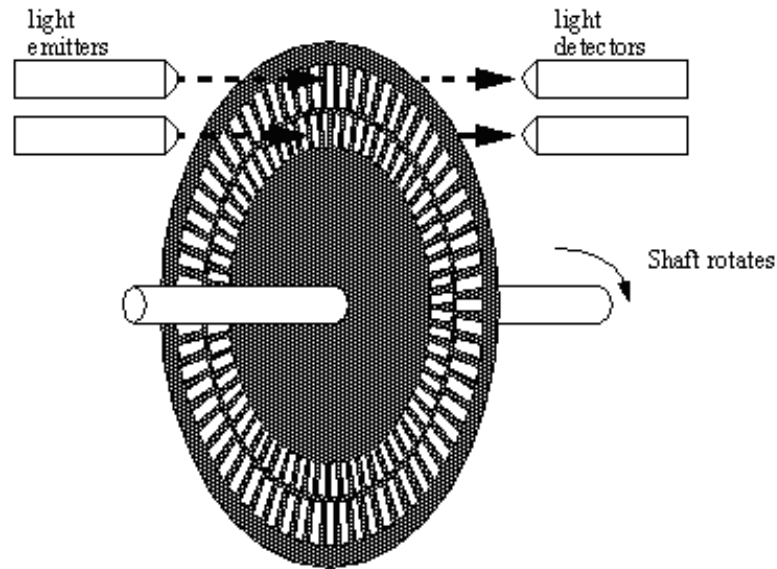

Figure 5.12 Wheel Encoder

The encoder is a sensor attached to a rotating object (such as a wheel or motor) to measure rotation. A typical encoder uses optical sensor(s), a moving mechanical component, and a special reflector to provide a series of electrical pulses. These pulses can be used as part of a feedback control system to determine translation distance, rotational velocity of a rotating component.

For instance, to measure the time it takes motor to rotate exactly 360 degrees or more or less, an encoder would be ideal. The sensor would be fixed on the shaft (the encoder wheel) would rotate with the shaft. The output of an encoder would be a square wave, so if you hook up this signal to a digital counter or microcontroller you can then count the pulses. Knowing the distance/angle between each pulse, and the time from start to finish, you can easily determine position or angle or velocity of the motor.

5.4 The importance of speed in Turbine's measurements

It was discussed earlier that the power output of a wind turbine is proportional to the cube of the speed. The speed is the most important parameter in evaluating the power from a turbine. It is often understated by manufacturers or misunderstood by buyers that the power rating of a wind turbine is only true at a given speed, known as the rated speed, which is neither too low nor too high, but somewhere where it is trusted that the wind turbine will be able to withstand the forces of rotation. These speeds are distinguished into four different regimes (Figure 5.13):

a. Start-up Speed –

This is the speed at which the rotor and blade assembly begins to rotate.

b. Cut-in Speed –

Cut-in speed is the minimum wind speed at which the wind turbine will generate usable power. This wind speed is typically between 7 and 10 mph for most turbines.

c. Rated Speed –

The rated speed is the minimum wind speed at which the wind turbine will generate its designated rated power. For example, a "10 kilowatt" wind turbine may not generate 10 kilowatts until wind speeds reach 25 mph. Rated speed for most machines is in the range of 25 to 35 mph. At wind speeds between cut-in and rated, the power output from a wind turbine increases as the wind increases. The output of most machines levels off above the rated speed. Most manufacturers provide graphs, called "power curves," showing how their wind turbine output varies with wind speed.

d. Cut-out Speed –

At very high wind speeds, typically between 45 and 80 mph, most wind turbines cease power generation and shut down. The wind speed at which shut down occurs is called the cut-out speed, or sometimes the furling speed. Having a cut-out speed is a safety feature which protects the wind turbine from damage. Shut down may occur in one of several ways. In some machines an automatic brake is activated by a wind speed sensor. Some machines twist or "pitch" the blades to spill the wind. Still others use "spoilers," drag flaps mounted on the blades or the hub which are automatically activated by high rotor rpm's, or mechanically activated by a spring loaded device which turns the machine sideways to the wind stream. Normal wind turbine operation usually resumes when the wind drops back to a safe level.

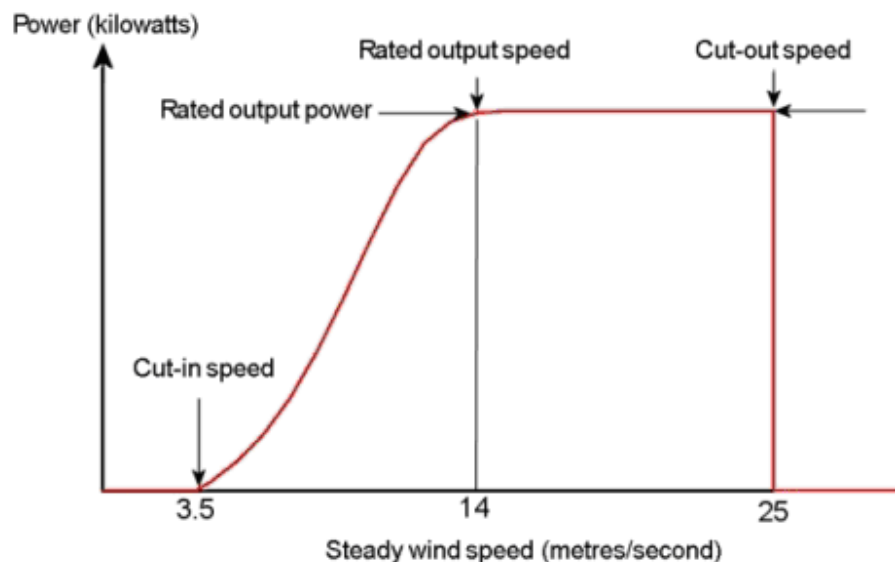

Figure 5.13 Wind speeds for a wind turbine

6 Worked Examples

Worked Example 6.1

The table below summarises the data for a wind turbine to be installed. Determine the annual power output for this turbine on this particular site.

Set	Wind Speed (m/sec)	Turbine Output (kW)	No of hours per year at given wind speed
(a)	(b)	(c)	(d)
1	4	2	1100
2	5	4	1100
3	6	6	1000
4	7	8	900
5	8	10	800
6	9	10	600
7	10	10	400
8	11	10	300
9	12	10	200
10	13	10	100

Solution:

First calculate the power output for each speed group, and then add them up as shown below. Hence the annual output is calculated as 43.8 MWh per year

Set	Wind Speed (m/sec)	Turbine Output (kW)	No of hours per year at given wind speed	Power output kWh (c x d)
(a)	(b)	(c)	(d)	(e)
1	4	2	1100	2200
2	5	4	1100	4400
3	6	6	1000	6000
4	7	8	900	7200
5	8	10	800	8000
6	9	10	600	6000
7	10	10	400	4000
8	11	10	300	3000
9	12	10	200	2000
10	13	10	100	1000
				43800

Worked Example 6.2

If the average wind speed of 10 mph which yields 100 watts per square meter, Determine the power produced by a wind mill when the wind speed is 40 mph.

Please click the advert

The financial industry needs a strong software platform
That's why we need you

Working at SimCorp means making a difference. At SimCorp, you help create the tools that shape the global financial industry of tomorrow. SimCorp provides integrated software solutions that can turn investment management companies into winners. With SimCorp, you make the most of your ambitions, realising your full potential in a challenging, empowering and stimulating work environment.

Are you among the best qualified in finance, economics, computer science or mathematics?

Find your next challenge at www.simcorp.com/careers

Mitigate risk | Reduce cost | Enable growth
simcorp.com

SimCorp

"When I joined SimCorp, I was very impressed with the introduction programme offered to me."

Meet Lars and other employees at simcorp.com/meetouremployees

Solution:

The change in wind speed means that wind blows at the ratio of

$(40/10 = 4)$ times

Since the power is proportional to wind speed to power 3,

Hence an increase in wind velocity of 4 times, implies that the power will be increased by a factor of:

$$4^3 = 64$$

Therefore, if a 10 mph wind gives you 100 watts

Then a 40 mph wind gives you 64 times more power

$$= 64 \times 100 = 6400 \text{ watts}$$

$$= 6.4 \text{ kW.}$$

Worked Example 6.3

The following specifications for two HAWT are supplied by the manufacturers.

Item	Turbine A	Turbine B
Rotor diameter	25m	28m
Power coefficient	38	35
Gearbox efficiency	90	88
Generator efficiency	98	95
Capital cost	£99,000	£103,000
Maintenance cost/year	£4,000	£4,000

- a. draw up a table for the performance of each turbine for wind speeds 4-12 m/s in intervals of 2 m/s
- b. Assume the site wind availability to be 2000 hours per year, and average wind speed of 6 m/s, select the wind turbine which will be most economical. Assume life expectancy for each to be 20 years, and the unit cost of power to be 6 pence per kWh to remain constant.

Solution:

(a)The shaft power of a wind rotor is given by:

$$P = C_p * 1/2 * \rho * A * V^3 * \eta_{gb} * \eta_{gen}$$

Wind speed m/s	Turbine A Power (kW)=98.713V ³	Turbine B Power(kW)=108.101V ³
4	6.317	6.918
6	21.322	23.350
8	50.541	55.348
10	98.713	108.101
12	170.576	186.799

(b) at 6 m/s, Turbine B, produce more power

The annual difference = (23.350-21.322)x2000 = 4056 kWh

Cost difference over 20 years = 4056x0.06x20 = £4867

Hence Turbine B is chosen even though it is £4000 more expensive to buy than A, with a net saving of £867.

Please click the advert

What do you want to do?

No matter what you want out of your future career, an employer with a broad range of operations in a load of countries will always be the ticket. Working within the Volvo Group means more than 100,000 friends and colleagues in more than 185 countries all over the world. We offer graduates great career opportunities – check out the Career section at our web site www.volvogroup.com. We look forward to getting to know you!

VOLVO
 AB Volvo (publ)
www.volvogroup.com

VOLVO TRUCKS | RENAULT TRUCKS | MACK TRUCKS | VOLVO BUSES | VOLVO CONSTRUCTION EQUIPMENT | VOLVO PENTA | VOLVO AERO | VOLVO IT
 VOLVO FINANCIAL SERVICES | VOLVO 3P | VOLVO POWERTRAIN | VOLVO PARTS | VOLVO TECHNOLOGY | VOLVO LOGISTICS | BUSINESS AREA ASIA

Worked Example 6.4

In order to study the relationship between the current (I), voltage (V) and resistance (R) as related by Ohms law, see the circuit below; calculate:

- The current (I) in the circuit shown below, for given values of voltage ($V=12\text{v}$) and resistance ($R=3\text{ ohm}$)
- The resistance (R) in a circuit, given values of voltage ($V=24\text{v}$) and current ($I=4\text{Amps}$)
- The voltage supplied by a battery, given values of current ($I=2\text{ Amps}$) and resistance ($R=6\text{ ohms}$). Determine the power consumption of the lamp in this case.

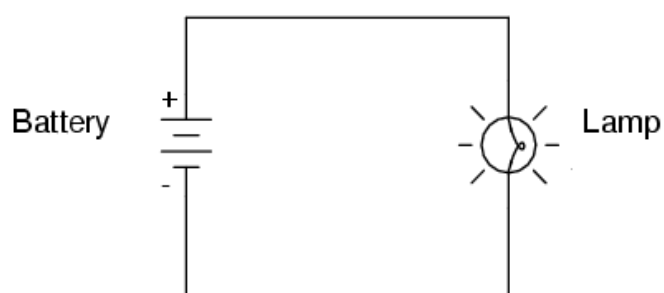

Solution:

a. Using Ohms Law, the current:

$$I = \frac{V}{R} = \frac{12}{3} = 4 \text{ Amps}$$

b. The resistance in the circuit is

$$R = \frac{V}{I} = \frac{24}{4} = 6 \Omega$$

c. The voltage provided by the battery is:

$$V = I \times R = 2 \times 6 = 12 \text{ Volts}$$

The power consumption of the lamp is:

$$E = I^2 \cdot R = 2^2 \times 6 = 24 \text{ Watts}$$

Worked Example 6.5

Determine the currents associated in each branch of the circuit shown below, and the power of the battery.

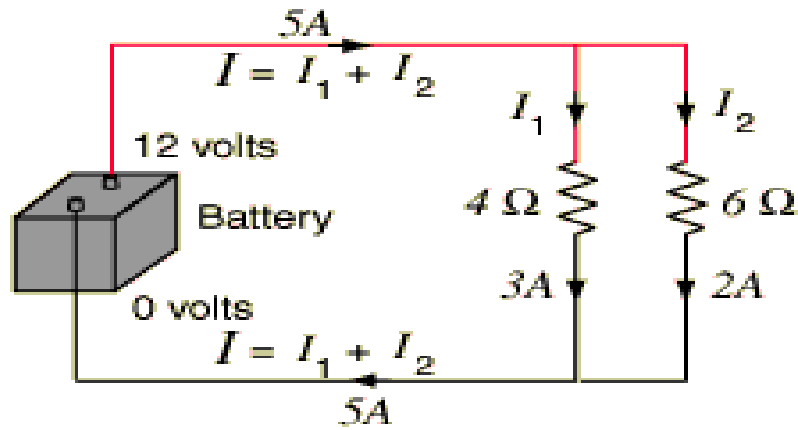

Please click the advert

RedStarResume.

Do you want your Dream Job?

More customers get their dream job by using RedStarResume than any other resume service.

RedStarResume can help you with your job application and CV.

**Go to: Redstarresume.com
Use code "BOOKBOON" and save up to \$15**

(enter the discount code in the "Discount Code Box")



Solution:

Remember that in parallel branching the voltage in each branch is the same as that in the main battery.

$$I_1 = \frac{V}{R} = \frac{12}{4} = 3\text{Amps}$$

$$I_2 = \frac{V}{R} = \frac{12}{6} = 2\text{Amps}$$

in parallel branching the current in each branch depends on the resistance of the branch, the total current in the battery is the sum of both currents flowing in each branch.

Hence the total current flowing through the battery

$$I = 3 + 2 = 5 \text{ Amps.}$$

The power of the battery is

$$E = V.I = 12 \times 5 = 60 \text{ Watts}$$

7 Tutorial Problems

- 7.1 Calculate the power delivered by the wind, in watts per square metre, for wind speed over a range from 1 to 20 metres per second. (Assume the density of air at normal pressure to be 1.23 kg per cubic metre.)

Ans [10W, 1 W, 2 Amps]

- 7.2 The rotor diameter of a two-bladed HAWT is 7.0 metres. At its rated wind speed of 12.1 metres per second, the power output of the turbine is 15 kW.

- (a) Find the efficiency of the turbine at this wind speed. (The density of air is 1.23 kg per cubic metre.)
(b) Calculate the tip-speed ratio, if the blades are rotating at 240 rpm.

Ans [10W, 1 W, 2 Amps]

- 7.3 A two-bladed horizontal axis wind generator has a rotor diameter of 20 metres.

- (a) Operating at a wind speed of 8.1 metres per second, the rotor extracts 35% of the energy of the wind. If the efficiency of the generator which it drives is 85%, find the electrical power output in kilowatts. (The density of air is 1.23 kg per cubic metre.)
(b) The output power of a turbine is equal to the torque exerted by the blades multiplied by the angular velocity (which is approximately 0.1 times the rpm). If the above turbine is rotating at 60 rpm, what is the torque?

Ans [10W, 1 W, 2 Amps]

- 7.4 A wind Turbine, 3m rotor diameter, produce 1 kW when the average wind speed is 10 m/s. Determine the power coefficient if the gear box and generator are 100% efficient and the air density is assumed constant as 1.2 kg/m³.

Ans [0.236]

- 7.5 The total energy input to power stations in the UK in 1990 was 3.05 EJ and the total electrical output was 300 TWh. The installed generating capacity was 68 GW.

- (a) Calculate the average energy conversion efficiency of the system.
(b) Calculate the maximum possible annual output in TWh, i.e. the output if every power station had run at full capacity for the entire year.

The actual output expressed as a percentage of this maximum is called the annual load factor of the system. Show that the annual load factor for 1990 was 50%.

- 7.6 A coal-fired power station with an output of 660 MW operates at an overall efficiency of 35%. The heat energy released by the burning coal is 28 GJ per tonne.
- How many tonnes an hour of coal must be supplied to the plant when it operates at full output?
 - Burning one tonne of coal releases 3.4 tonnes of carbon dioxide. If the above power-station runs with an average plant load factor of 70%, show that it releases five million tonnes of CO₂ a year.
- 7.7 The rate at which an electrical supply provides energy is equal to its voltage multiplied by the current which it is supplying. ('Watts equal volts times amps.')
- A certain 12 V car battery, when fully charged, can supply the equivalent of 1 amp for 40 hours (40 amp-hour rating). Calculate the total energy it can supply, in joules.
 - A car is parked and left with two 25 W headlamp bulbs switched on. If the battery is initially fully charged, after how many hours will all its stored energy have been used?
 - Electric vehicles use batteries instead of petrol as 'portable energy stores'. If an electric car used the above type of battery, how many would be needed to store the same energy as 40 litres of petrol.
- (Assume that the energy content of petrol is 35 MJ per litre.)
- 7.8 The capital cost of a wind turbine generator is €20 000, and its operation and maintenance costs will be €400 a year. The plant is expected to operate for 25 years.
- Calculate the present value of the €400 annual operating and maintenance costs over the 25-year period, using a discount rate of 10%. Add this to the €20 000 capital cost to obtain the present value of the total cost.
 - The generator is expected to supply 28 000 kWh a year for the 25 years. Show that the 'present value' of the total output, again discounted at 10% a year, is 254 thousand kWh.
 - Use the results of (a) and (b) to find the cost of electricity in pence per kWh.
- 7.9 The rotor diameter of a two-bladed HAWT is 7.0 metres. At its rated wind speed of 12.1 metres per second, the power output of the turbine is 15 kW.
- Find the efficiency of the turbine at this wind speed. (The density of air is 1.23 kg per cubic metre.)
 - Calculate the tip-speed ratio, if the blades are rotating at 240 rpm.

- 7.10 A two-bladed horizontal axis wind generator has a rotor diameter of 20 metres.
- Operating at a wind speed of 8.1 metres per second, the rotor extracts 35% of the energy of the wind. If the efficiency of the generator which it drives is 85%, find the electrical power output in kilowatts. (The density of air is 1.23 kg per cubic metre.)
 - The output power of a turbine is equal to the torque exerted by the blades multiplied by the angular velocity (which is approximately 0.1 times the rpm). If the above turbine is rotating at 60 rpm, what is the torque?
- 7.11 For the circuit shown below find the Voltage V , and the Power P consumed by the load $R=12$ ohms. What power is needed if the current is doubled?

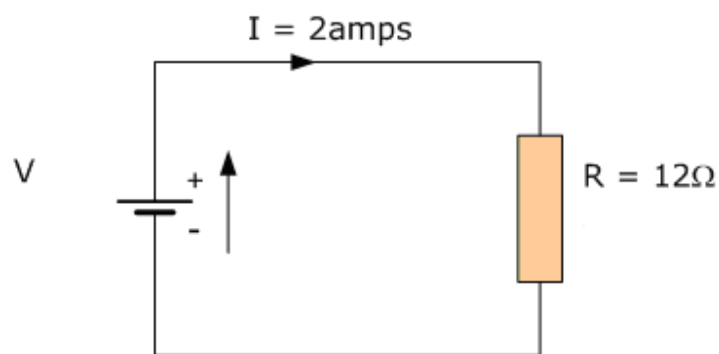

Ans(24v, 48W, 192W)

- 7.12 A string of Christmas tree lights, consisting of twenty lamps, is connected in series across the 240 V mains supply. The power consumption of the whole string is 24 W.

Calculate the resistance of each lamp.

Ans (120 ohm)

8 Case Study

8.1 Site Survey of wind energy and wind turbine matching

The energy available in a wind stream is a critical element in projecting wind turbine performance and availability at a specific site. In general, availability of power in the wind influences the choice of a wind turbine in terms of the type of configuration, its rotor size and its siting.

This study will present a software package especially written using the Microsoft Excel program for Windows, to use the availability of wind energy on a given site under given wind conditions in order to evaluate the pattern and amount of energy possible to collect at any one time. The software package processes the data from a typical wind database, calculates and plots graphs concerning Annual Energy Output (A.E.O.), Power Curves for a range of manufacturers, Wind Speed Frequency, Wind Speed Distribution and Wind Speed Vertical Profile.

The package utilises two principles in the calculations namely: The Swept Area Method and the Power Curve Method.

Try this...



The sequence 2, 4, 6, 8, 10, 12, 14, 16, ... is the sequence of even whole numbers. The 100th place in this sequence is the number...?

Challenging? Not challenging? Try more >>

www.alloptions.nl/life

Please click the advert

8.2 Introduction

Wind energy has been used for thousands of years for milling grain, pumping water, and other mechanical power applications. Today, there are over one million windmills in operation around the world. These are used principally for water pumping and providing electricity for remote regions. On a pan European front, a total of 8,484 MW wind power capacity was installed in the EU in 2008. This puts wind energy ahead of any other power technology for the first time. 36% of all new electricity producing capacity installed in the EU in 2008 was wind energy followed by natural gas (6,932 MW - 29%), oil (2,495 MW - 10%), coal (762 MW - 3%) and hydro (473 MW - 2%). At the end of 2008, there were 65 GW of wind power capacity installed in the EU-27 producing 142 TWh hours of electricity, and meeting 4.2% of EU electricity demand. A binding target of 20% renewable energy has been set for the EU to achieve by 2020 [2]. The UK is the windiest country in Europe, and if utilised effectively it could easily provide power to satisfy the 20% contribution of the UK market.

The cost of wind energy equipment fell steadily between the early 1980s and the early 1990s. The technology is continually being improved to make it both cheaper and more reliable, so it can be expected that wind energy will become economically competitive with fossil fuels during the coming decades [3].

8.3 Energy and power in the wind

Kinetic energy of the wind is $\frac{1}{2} [\text{mass} \cdot (\text{velocity})^2]$ (8.1)

If ρ = density of air, V = relative velocity of the wind and A = flow - swept area through which the wind stream passes, then the mass flow rate of air is ρAV . Hence the kinetic energy from equation (8.1) is rewritten as:

$$P_w = \frac{1}{2} \rho A V^3 \quad (8.2)$$

Note that this is the ideal power available (P_w), in the wind. Only a fraction of this power can actually be extracted, because of losses that incurred in the energy conversion process.

Useful power which can be extracted by the turbine rotor is given by multiplying the available power by a coefficient of performance C_p for the particular turbine. C_p has a maximum theoretical value of 0.593 (Betz' law). Other losses incurred in conversion through the gearbox and generator..

Thus the actual power output ($P_{w/t}$) of a wind turbine rotor is:

$$P_{w/t} = C_p \cdot \eta_{\text{gen}} \cdot \eta_{\text{gb}} \cdot \frac{1}{2} \rho A V^3 \quad (8.3)$$

η_{gen} = generator efficiency (50% for car alternator, 80% or possibly more for a permanent magnet generator or grid-connected induction generator)

η_{gb} = gearbox / bearings efficiency (depends, could be as high as 95% if good)

The wind variation for a typical site is usually described using the so-called Weibull distribution. The Weibull distribution represents a mathematical distribution which resembles the distribution of different wind speeds throughout the year. It's a statistical model that gives the probability of occurrence. The basic equation is:

$$p(U) = \frac{k}{C} \cdot \left[\frac{U}{C} \right]^{k-1} \cdot \exp \left\{ - \left[\frac{U}{C} \right]^k \right\} \quad (8.4)$$

The Rayleigh distribution is a special case of the Weibull distribution in which the shape factor $k = 2$. Thus the Rayleigh equation is:

$$p(U) = \frac{\delta \cdot U}{2 \cdot v^2} \cdot \exp \left[- \frac{\delta \cdot U^2}{4 \cdot v^2} \right] \quad (8.5)$$

Where v is the annual average wind speed at hub height h above ground level.

Wind turbine manufacturers often present performance figures for their machines using the Rayleigh distribution.

Figures 8.1, and 8.2 depict two different Rayleigh distributions for two different values of wind speeds (3 and 8 m/s respectively).

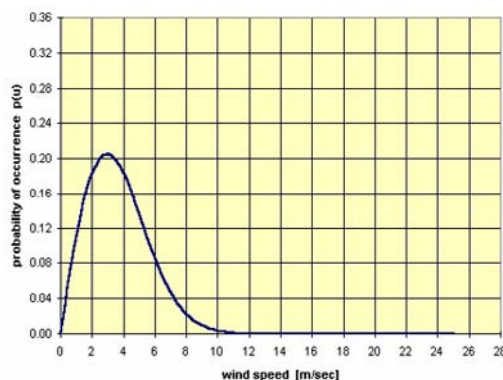

Figure 8.1: wind speed $v = 3$ m/s

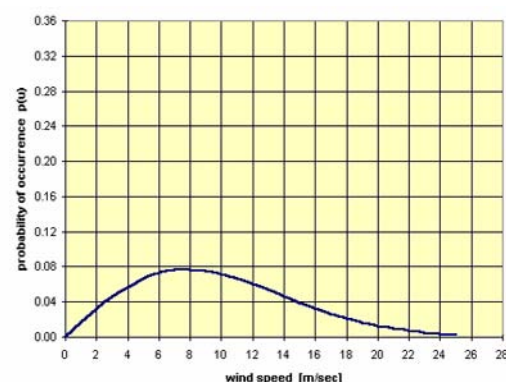

Figure 8.2: wind speed $v = 8$ m/s

8.4 Estimating the Annual Energy Output (A.E.O.)

$$\text{wind speed frequency} = 8760 \times p(U) \quad \text{in [hours/yr]} \quad (8.6)$$

Then the wind speed frequency is matching with the power curve to estimate the Annual Energy Output (AEO). Thus:

$$(\text{AEO}) = \text{power} \times \text{wind speed frequency} \quad \text{in [kWh/yr]} \quad (8.7)$$

Finally the total annual energy output (AEO) is calculated by summing the energy produced (kWh/yr) at all wind speeds within the operating range of each wind turbine, and dividing by 10^6 to get results in [GWh/yr]

$$\text{Total (AEO)} = \sum \frac{(\text{AEO})}{10^6} \quad \text{in [GWh/yr]} \quad (8.8)$$

8.5 The Software Package

The aim of this study is to present a software package especially written using the Microsoft Excel program for Windows. The user is able to use the availability of wind energy on a given site under given wind conditions in order to evaluate the pattern and amount of energy possible to collect at any time during the year.

However, this software has the ability to examine any given site throughout the U.K.

In this software package there is available a database, of seven (7) different manufacturers and twenty eight (28) different models of various sizes covering a wide range from 0.5 kW to 2500 kW.

Finally, the software package is quite friendly to the user because requires just 5 simple steps before the user can get the desirable output.

Please click the advert

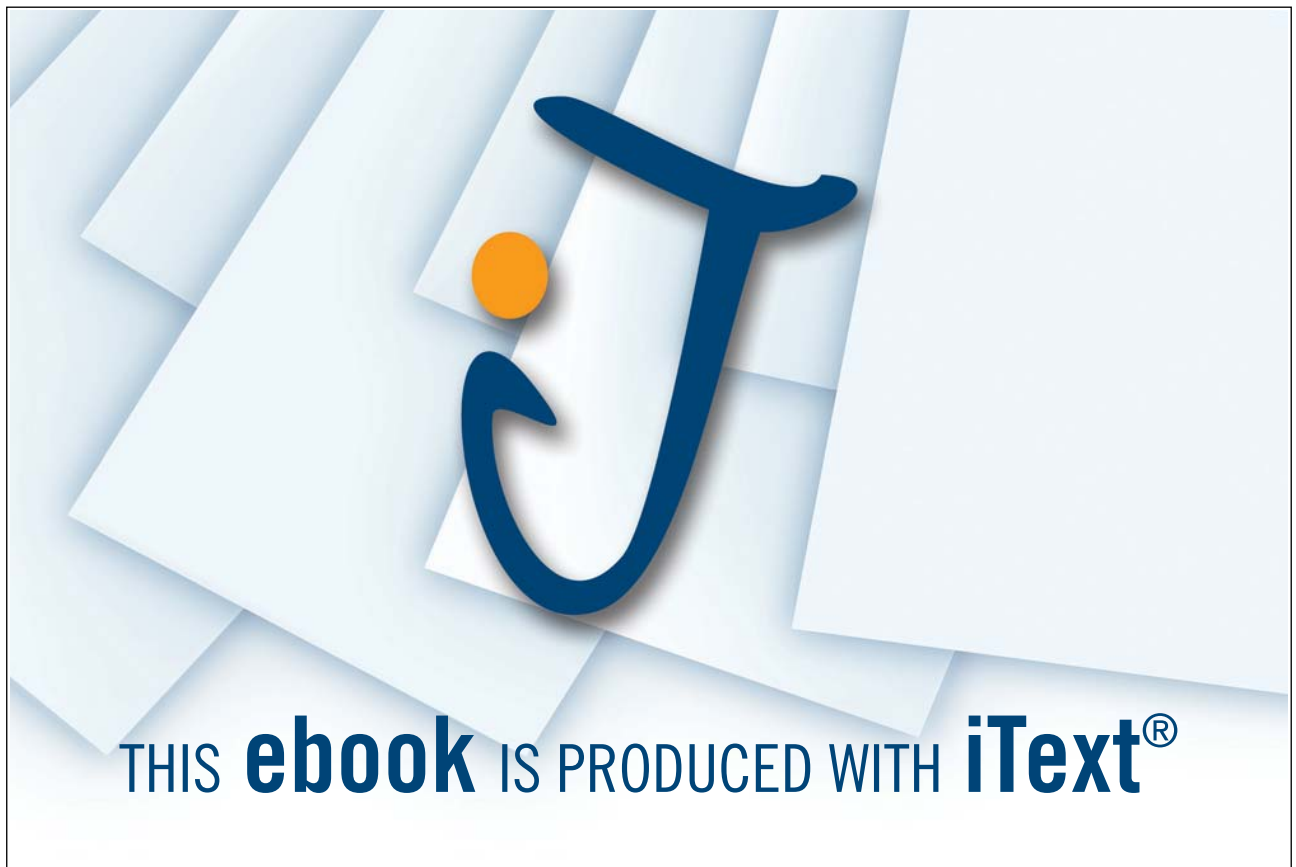

At the sheet named 'Calculations', [Figure 8.3] the user should enter the following inputs:

1. the annual average wind speed u at standard height $z = 10$ m
2. the index a which is a parameter relative to surface roughness
The user can find a Table indicating the values to be expected to certain types of terrain at the sheet named 'Help Menu'.
3. the hub height h . In this software package there are available eight different values of height h i.e. $h = 10$ m, 20 m, 30 m, 40 m, 50 m, 60 m, 70 m, 80 m.
Height requirements for medium and large wind turbines are 20 - 80 m.
Height requirements for small wind turbines are up to 20 m.
4. the name of the manufacturer
5. the name of the model
In this software package there is available a database of seven different manufacturers and twenty eight different models of various sizes (from 0,5 kW - 2500 kW)

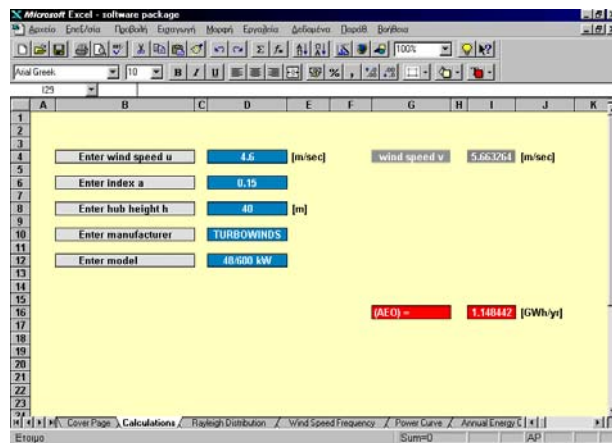

Figure 8.3: Main menu

The user then get the following output:

1. the annual average wind speed v at hub height for the above 8 different values of height h
2. the total Annual Energy Output (AEO) in [GWh/yr]

The 'Rayleigh Distribution', [Figure 8.4] shows a graph of a mathematical distribution called the Rayleigh distribution which resembles the distribution of different wind speeds throughout the year.

The 'Wind Speed Frequency', [Figure 8.5] is showing the number of hours for which the wind blows at different wind speeds, during a given period of time.

The 'Power Curve', [Figure 8.6] displays the values of instantaneous power in [kW] given from manufacturers for each model of the database of this software package.

The 'Annual Energy Output', [Figure 8.7] graph displays values of energy in [kWh/yr] for all the wind speeds in the range of 0 - 25 m/sec.

The 'Wind Speed Vertical Profile', is shown in [Figure 8.8].

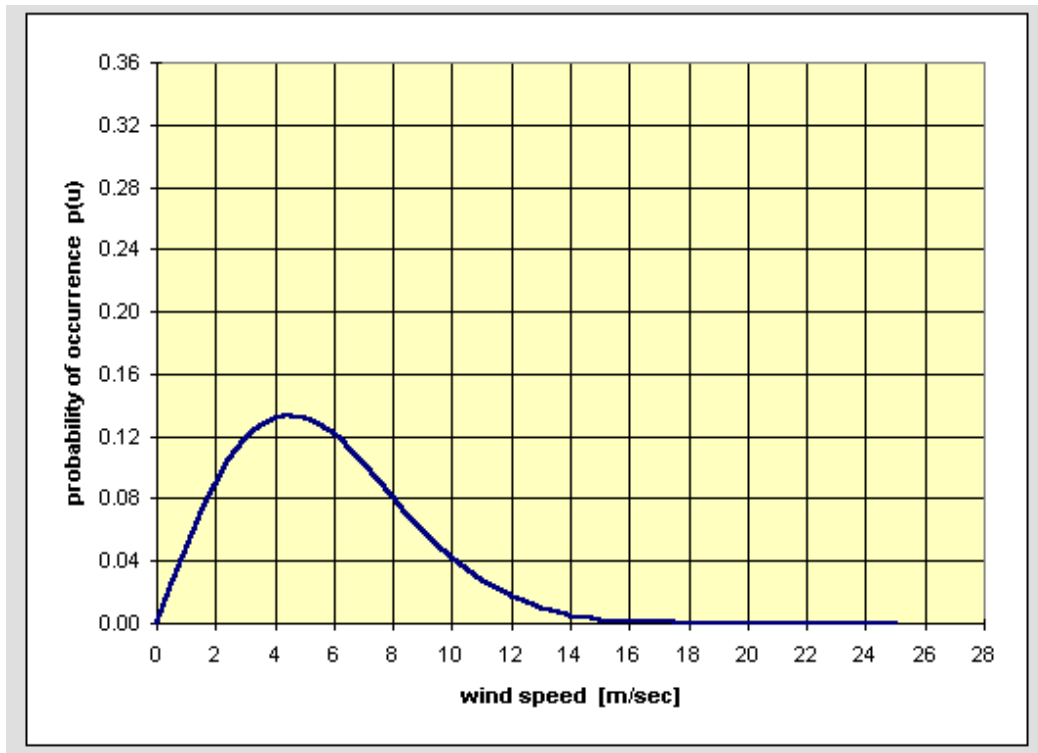

Figure 8.4: The 'Rayleigh Distribution'

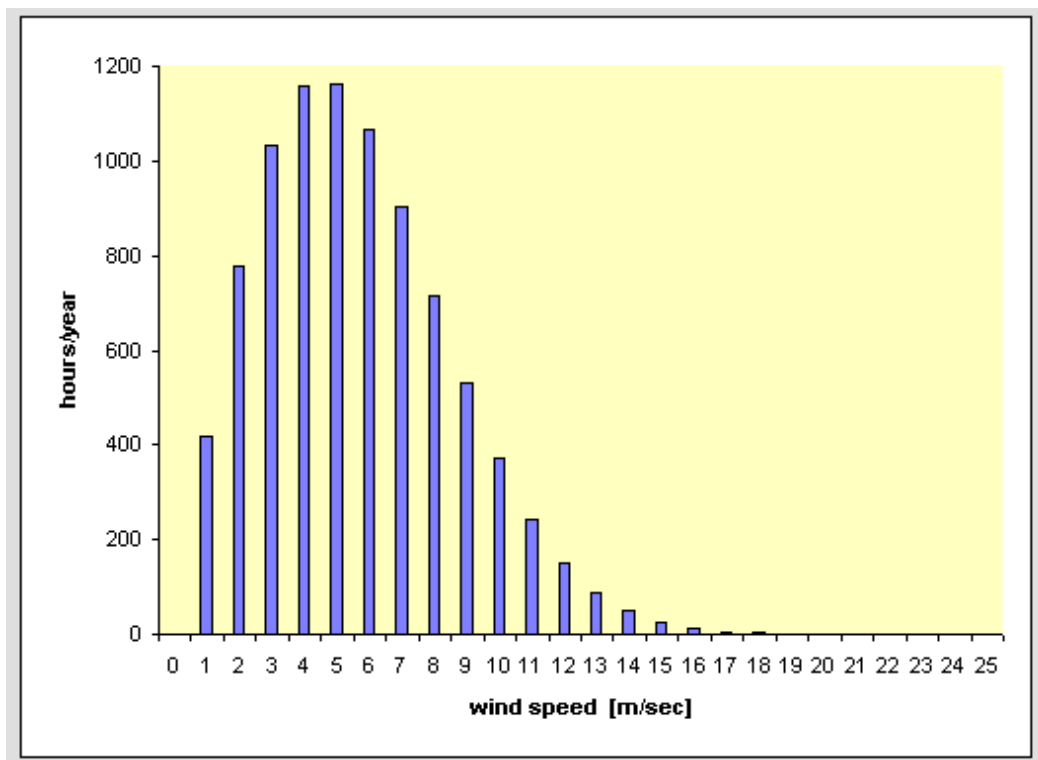

Figure 8.5: The 'Wind speed frequency' menu

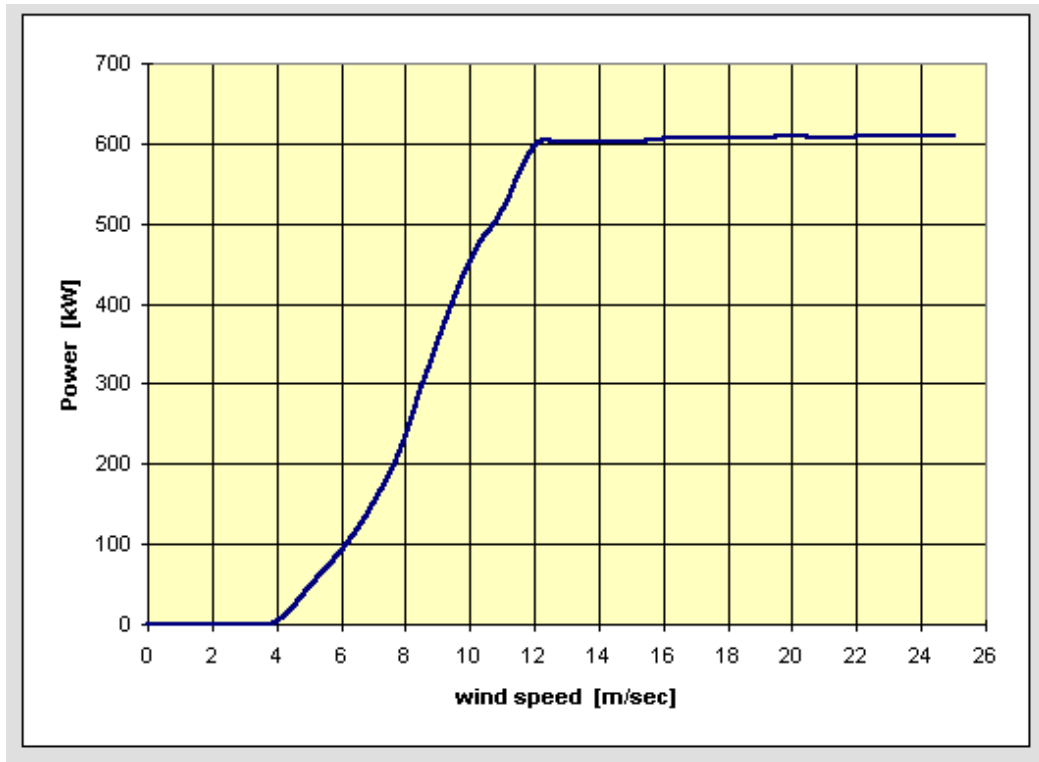
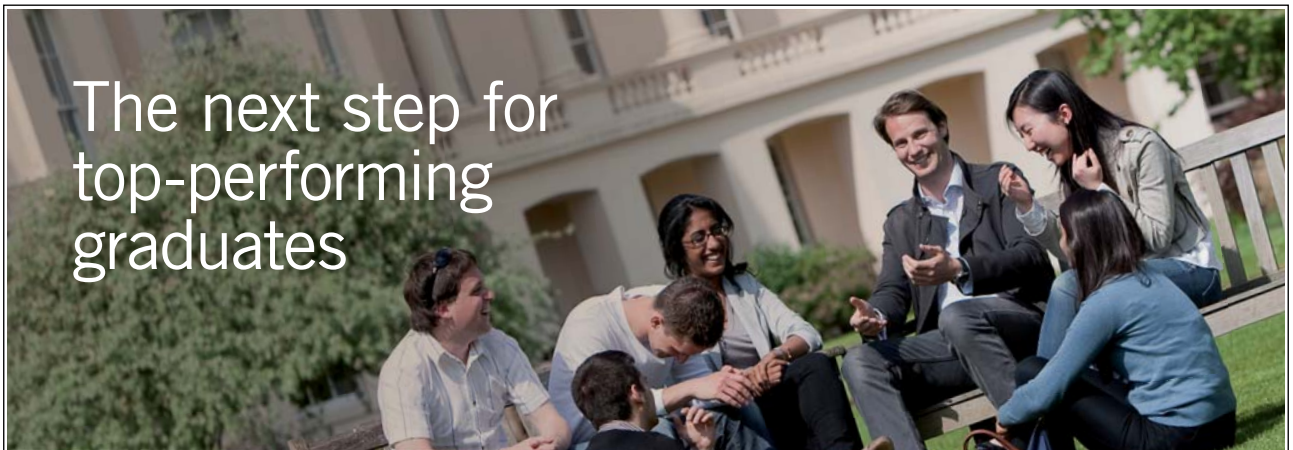

Figure 8.6: The 'Power curve' menu



Please click the advert

Masters in Management

Designed for high-achieving graduates across all disciplines, London Business School's Masters in Management provides specific and tangible foundations for a successful career in business.

This 12-month, full-time programme is a business qualification with impact. In 2010, our MiM employment rate was 95% within 3 months of graduation*; the majority of graduates choosing to work in consulting or financial services.

As well as a renowned qualification from a world-class business school, you also gain access to the School's network of more than 34,000 global alumni – a community that offers support and opportunities throughout your career.

For more information visit www.london.edu/mm, email mim@london.edu or give us a call on **+44 (0)20 7000 7573**.

* Figures taken from London Business School's Masters in Management 2010 employment report



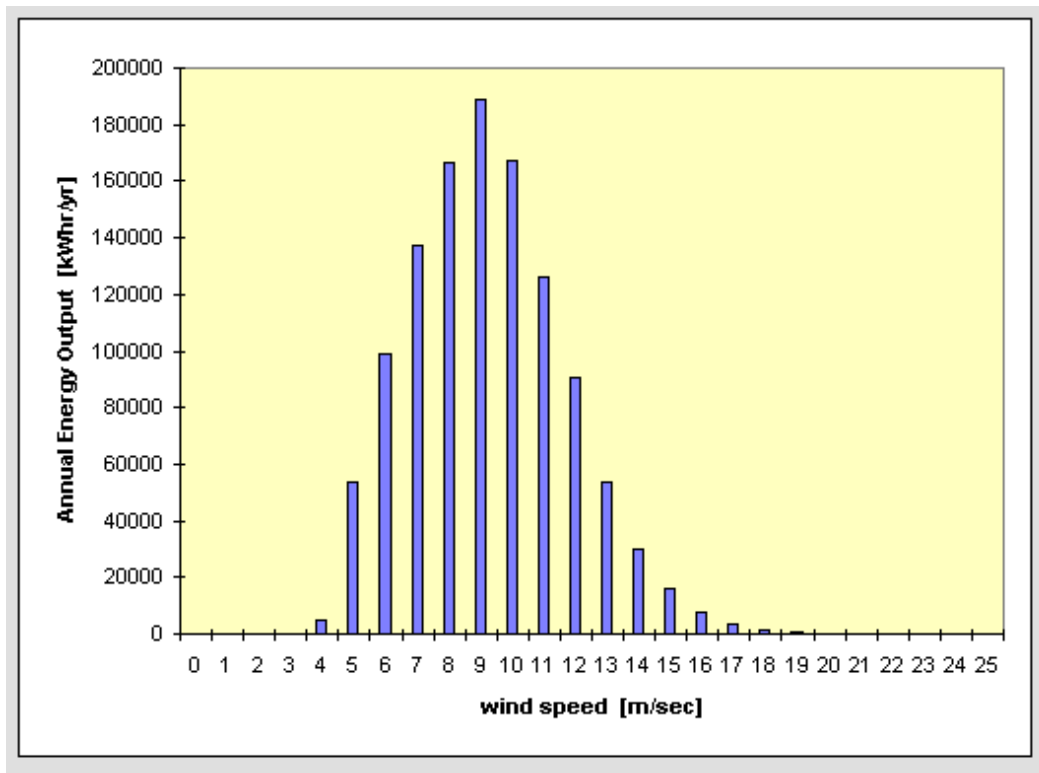

Figure 8.7: The (A.E.O.) menu

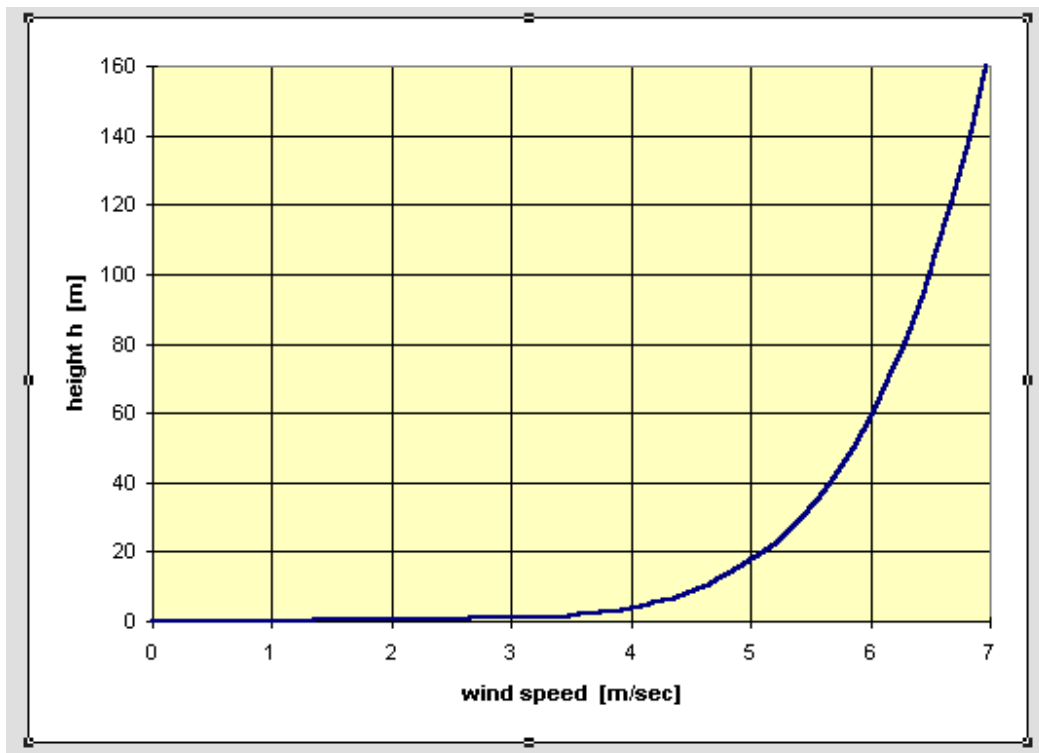

Figure 8.8: The 'Wind speed vertical profile'

8.6 Discussion

Consider six different wind turbines with rated power of 600 - 660 kW which is the most common value for most modern wind turbines in the market, shown in Table 1, taken from references [7, 8, 9, 10, and 11].

a/a	Manufacturer	Model
1.	JACOBS	43/600 kW
2.	BONUS	44/600 kW
3.	NORDEX	43/600 kW
4.	TURBOWINDS	48/600 kW
5.	VESTAS	42/600 kW
6.	VESTAS	47/660 kW

Table 1: Various wind turbines with rated power of 600 - 660 kW

Note that the 2 first digits in the column ‘Model’ of Table 1 represent the diameter D in [m] and the following 3 digits represent the rated output in [kW].

Consider the following values for a given site:

$u = 4,6$ m/sec; $a = 0,15$; hub height of $h = 40$ m. The following figures, shows the initial conditions, and Table 2 show the results for the 6 different models.

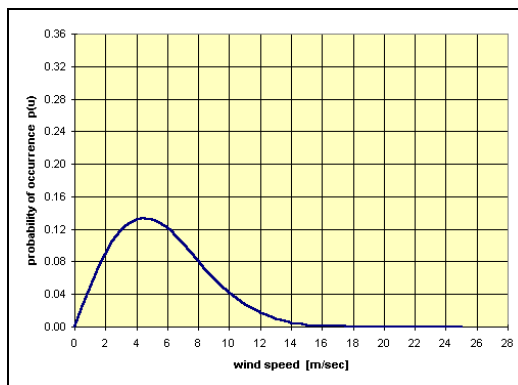

Figure 8.9

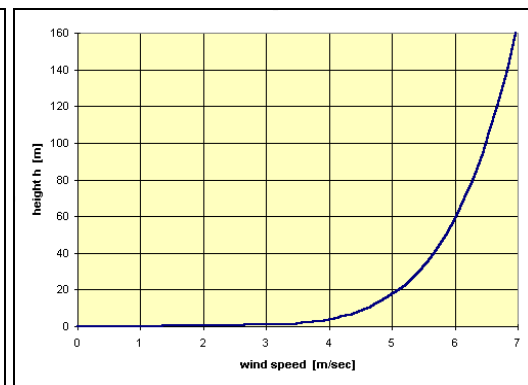

Figure 8.10

a/a	Manufacturer	Model	(A.E.O.) [GWh/yr]
1.	JACOBS	43/600 kW	0,966
2.	BONUS	44/600 kW	1,009
3.	NORDEX	43/600 kW	0,987
4.	TURBOWINDS	48/600 kW	1,148
5.	VESTAS	42/600 kW	0,903
6.	VESTAS	47/660 kW	1,184

Table 2: Annual Wind Energy Output.

From Table 2 the conclusion is that the most beneficial choices are between the VESTAS 47/660 and the TURBOWINDS 48/600. However, further considerations (i.e. the price of the machine, its reliability, and the cost of operation and maintenance) must be examined before the final decision is made.

Please click the advert

Excellent Economics and Business programmes at:



university of
 groningen



“The perfect start
of a successful,
international career.”

CLICK HERE
to discover why both socially
and academically the University
of Groningen is one of the best
places for a student to be

www.rug.nl/feb/education

Manufacturer / Model	(A.E.O.) Software Package [GWh/yr]	(A.E.O.) Official Data [GWh/yr]
JACOBS 7.5/10 ⁽²⁾ [5]	0,016	0,013
JACOBS 8.0/15 ⁽²⁾	0,018	0,015
JACOBS 8.5/17.5 ⁽²⁾	0,026	0,019
JACOBS 9.5/20 ⁽²⁾	0,027	0,026
JACOBS 43/600 ⁽³⁾	0,966	0,878
JACOBS 48/750 ⁽³⁾	1,212	1,190
JACOBS 77/1500 ⁽⁴⁾	3,594	3,516
NORDEX 29/250 ⁽³⁾ [6]	0,452	0,432
NORDEX 43/600 ⁽³⁾	0,987	0,927
NORDEX 50/800 ⁽³⁾	1,284	1,264
NORDEX 54/1000 ⁽⁴⁾	1,819	1,643
NORDEX 60/1300 ⁽⁴⁾	2,326	2,186
NORDEX 80/2500 ⁽⁴⁾	4,351	N/A
VESTAS 42/600 ⁽³⁾ [7]	0,903	1,029
VESTAS 47/660 ⁽³⁾	1,184	N/A
VESTAS 66/1650 ⁽⁴⁾	2,807	N/A
VESTAS 66/1750 ⁽⁴⁾	3,542	N/A
VESTAS 80/2000 ⁽⁴⁾	4,360	N/A
WHISPER 1.5/0.5 ⁽¹⁾ [8]	0,0005	0,00043
WHISPER 2.1/0.9 ⁽¹⁾	0,0011	0,0008
WHISPER 2.7/1.0 ⁽¹⁾	0,0015	0,0013
WHISPER 4.5/3.0 ⁽¹⁾	0,005	0,004
BONUS 44/600 ⁽³⁾ [9]	1,009	N/A
BONUS 54/1000 ⁽⁴⁾	1,902	N/A
BONUS 62/1300 ⁽⁴⁾	2,482	N/A
TURBOWINDS 34/400 ⁽³⁾ [10]	0,619	0,578
TURBOWINDS 48/600 ⁽³⁾	1,148	1,118
NPS 5.0/3 ⁽¹⁾ [11]	0,004	0,005

Table 3: Comparison of (A.E.O.) values between the Software Package data and the Official Technical data from the manufacturers

- ⁽¹⁾ for wind turbines of rated power 0,5 - 3,0 kW, hub height $h = 10$ m
- ⁽²⁾ for wind turbines of rated power 10 - 20 kW , hub height $h = 20$ m
- ⁽³⁾ for wind turbines of rated power 250 - 999 kW, hub height $h = 40$ m
- ⁽⁴⁾ for wind turbines of rated power 1000 - 2500 kW, hub height $h = 70$ m

Initial conditions:

Annual average wind speed at a standard height $z = 10$ m, $u = 4,6$ m/sec. and Index $a = 0,1$.

However, with this Software Package the user is able to produce calculations from a limited database of twenty eight (28) different wind turbine models. This limitation occurs due to a programming error of the Microsoft Excel program. Nevertheless, the existing database covers a wide range of models of various sizes (from 0,5 - 2500 kW), helping the user to decide on a model of any size and application.

8.7 Conclusions

This study has achieved the development of a Software Package, which gives to the user the ability to evaluate the pattern and amount of energy possible to extract from the wind.

The package is quite accurate giving that way the opportunity to the user to make the right choice. It computes the wind energy resource evaluation by calculating the Annual Energy Output (A.E.O.), matching the best Turbine for the available wind resource. However, further considerations (i.e. the price of the machine, its reliability, and the cost of operation and maintenance) must be examined before the final decision is made.

8.8 References

- [1]: Twidell, J. and Weir, A. (2006) Renewable Energy Resources, published by Taylor & Francis.2nd.ed.
- [2]: The European Wind Energy Association (EWEA), <http://www.ewea.org>.
- [3]: A comparison of methodologies for monthly wind energy estimation(2009) by E. García-Bustamante , J. F. González-Rouco , P. A. Jiménez , J. Navarro, J. P. Montávez . Journal of Wind Energy, Volume 12 Issue 7, Pages 640 – 659.
- [4]: <http://www.jacobs-energie.com>
- [5]: <http://www.nordex.dk>
- [6]: <http://www.vestas.dk>
- [7]: <http://www.baywinds.com>

[8]: <http://www.bonus.dk>

[9]: <http://www.turbowinds.com>

[10]: <http://www.worldpowertech.com>

Please click the advert

Teach with the Best. Learn with the Best.

Agilent offers a wide variety of affordable, industry-leading electronic test equipment as well as knowledge-rich, on-line resources —for professors and students.

We have 100's of comprehensive web-based teaching tools, lab experiments, application notes, brochures, DVDs/CDs, posters, and more.



See what Agilent can do for you.
www.agilent.com/find/EDUstudents
www.agilent.com/find/EDUeducators

© Agilent Technologies, Inc. 2012

u.s. 1-800-829-4444 canada: 1-877-894-4414

Anticipate —Accelerate —Achieve



Agilent Technologies